

DAIKIN 3P74597-7B

VRV Outdoor- Air Processing Unit

MODELS
FXMQ125NFRV16
FXMQ200NFRV16
FXMQ250NFRV16

Installation manual :- Pg.No. 1-12

1. SAFETY PRECAUTIONS

Please read these "SAFETY PRECAUTIONS" carefully before installing air conditioning equipment and be sure to install it correctly.

WARNING: Failure to follow these instructions properly may result in personal injury or loss of life.

CAUTION: Failure to observe these instructions properly may result in property damage or personal injury, which may be serious depending on the circumstances.

After completing installation, conduct a test operation to confirm that the equipment operates without any problems. Then, explain to the customer how to operate the equipment and take care of it following the operation manual. Ask the customer to store the manual for future reference.

This air conditioner comes under the term "appliances not accessible to the general public".

This unit is a class A product. In a domestic environment this product may cause radio interference in which case the user may be required to take adequate measures.

WARNING: Ask your dealer or qualified personnel to carry out installation work. Do not attempt to install the air conditioner yourself. Improper installation may result in water leakage, electric shock or fire.

Install the air conditioner in accordance with the instructions in this installation manual. Improper installation may result in water leakage, electric shock or fire.

When installing the unit in a small room, take measures so that the refrigerant may not exceed the limiting concentration in the event of refrigerant leakage. Contact your dealer for further information. If the refrigerant leaks and exceeds the limiting concentration, it may lead to oxygen deficiency.

Be sure to use only the specified accessories and parts for installation work. Failure to use the specified parts may result in the unit falling, water leakage, electric shock or fire.

Install the air conditioner on a foundation strong enough to withstand the weight of the unit. If a foundation does not have sufficient strength, the equipment may fall and cause injury. Carry out the required installation work in consideration of strong winds, typhoons or earthquakes. If the installation work is not properly carried out, the unit may fall down and cause accidents. The electrical work must be carried out by the qualified electrician in accordance with the local laws and regulations and this installation manual. Make sure to provide a dedicated power supply circuit and never connect additional wiring to the existing circuit. An insufficient power supply capacity or improper electrical work may lead to electric shock or fire. Be sure to earth the air conditioner. Do not earth the unit to a utility pipe, lightning conductor or telephone earth lead. Imperfect earthing may result in electric shocks or fire. A high surge current from lightning or other sources may cause damage to the air conditioner. Be sure to install an earth leakage breaker. Failure to install an earth leakage breaker may result in electric shock or fire. Be sure to switch off the unit before touching any electrical parts. Touching a live part may result in electric shock. For wiring, use the specified wires to connect and fasten them firmly so that no external force from the wires may be applied to the terminal connections. If the wires are not firmly connected and fastened, it may cause heating or fire. When wiring the power supply and connecting the remote controller, wiring and transmission, wiring, position the wires so that the control box lid can be securely fastened. Improper positioning of the control box lid may result in electric shock, fire or the terminals overheating. If refrigerant gas leaks during installation, ventilate the area immediately. Toxic gas may be produced if the refrigerant comes into contact with fire. After completing installation, check for refrigerant gas leakage. Toxic gas may be produced if the refrigerant gas leaks into the room and comes into contact with a source of fire, such as a fan heater, stove or cooker.

2. BEFORE INSTALLATION

Follow national standards for installation work.

2-1 PRECAUTIONS

- The accessories needed for installation must be retained in your custody until the installation work is completed. Do not discard them.
- Decide upon a line of transport. Decide transportation medium.
- Leave the unit inside its packaging while moving, until reaching the installation site. Where unpacking is unavoidable, use a sling of soft material or protective plates together with a rope when lifting, to avoid damage or scratches to the unit.
- For the installation of an outdoor unit, refer to the installation manual attached to the outdoor unit.
- Do not install or operate the unit in rooms mentioned below.
 - Laden with mineral oil, or filled with oil vapor or spray like in kitchens. (Plastic parts may deteriorate which could eventually cause the unit to fall out of place, or could lead to leaks.)
 - Where corrosive gas like sulfuric acid exists. (Copper tubing and brazed spots may corrode which could eventually lead to refrigerant leaks.)
 - Where exposed to combustible gases and where voltage flammable gas like thinner or gasoline is used. (Gas in the vicinity of the unit could ignite.)
 - Where machines can generate electromagnetic waves. (Control system may malfunction.)
 - Where the air contains high levels of salt such as that near the ocean and where voltage fluctuates greatly such as that in factories. Also in vehicles or vessels.
 - This unit, both indoor and outdoor, is suitable for installation in a commercial and light industrial environment. If installed as a household appliance it could cause electro-magnetic interference.

2-2 ACCESSORIES

Check that the following accessories are provided and that each accessory is correct in amount.

[PRECAUTION] The accessories are required for the installation of the air conditioner. Be sure to keep them until the installation work is completed.

Name	Attached piping (1)	(Other)
Quantity	1 set	• Installation & Operation manual
Shape		• Screws for flange connection (M5) • Insulation material (for hanger)(2 pcs.) • Washers (8 pcs.) • Clamps (2 pcs.) • Tie-wrap (2 pcs.) • E-waste (Guidelines) • Plain washer wood (8 pcs.)

2. REFRIGERANT PIPING WORK

As for the refrigerant piping of the outdoor unit, refer to the installation manual provided to the outdoor unit.

Perform heat insulation work on both gas piping and liquid piping or otherwise water leakage may occur.

Use the insulation material that withstands a temperature of 120°C.

Reinforce the insulation material for the refrigerant piping if the ambient temperature is high, or otherwise dew condensation may occur on the surface of the insulation material. Make sure that the refrigerant is R410A before refrigerant piping work. If the refrigerant is different, the air conditioner will not operate normally.

CAUTION

Do not excessively tighten the flare nut. Doing so will break the flare nut and refrigerant leakage may occur.

Make sure that all parts around the flare are free of oil. The drain pan and the resin part may be deteriorated if oil is attached.

If no torque wrenches are available, refer to Table 3 as a standard. When the flare nut is tightened with the spanner, the tightening torque should increase suddenly. Tighten the flare nut further for the corresponding angle shown in Table 3.

Pipe size	Further tightening angle	Recommended arm length of tool
φ9.5	60 to 90 degrees	Approx. 200mm

6. REFRIGERANT PIPING WORK

As for the refrigerant piping of the outdoor unit, refer to the installation manual provided to the outdoor unit.

Perform heat insulation work on both gas piping and liquid piping or otherwise water leakage may occur.

Use the insulation material that withstands a temperature of 120°C.

Reinforce the insulation material for the refrigerant piping if the ambient temperature is high, or otherwise dew condensation may occur on the surface of the insulation material. Make sure that the refrigerant is R410A before refrigerant piping work. If the refrigerant is different, the air conditioner will not operate normally.

7. DRAIN PIPING WORK

On completion of installation work, check that there is no gas leakage.

Refer to the illustration on the right hand side and be sure to perform heat insulation work on the piping joints after gas leakage checks.

NOTE: Attached piping is needed for connecting gas piping. Use attached piping according to the size of the piping to be connected. When connecting the included piping, use the included piping flange hex bolts (2) and spring washers (2).

Connect refrigerant piping and brazing according to the attached installation manuals that come with the outdoor unit.

Indoor units to be connected	Gas piping diameter	Liquid piping diameter
FXMQ125NFRV16	φ1 5.9 Use attached piping.	φ9 .5
FXMQ200NFRV16	φ1 9.1 Use attached piping.	φ9 .5
FXMQ250NFRV16	φ2 2.2 Use attached piping.	φ9 .5

Central drain pipe
Install with a downward slope of at least 1/100

Water supply port
After piping work is finished, check drainage flows smoothly.
Add approximately 1 liter of water slowly into the drain pan and check drainage flow.

CAUTION

Be sure to perform the heat insulation of the local piping up to the piping joint. If the piping is exposed, dew condensation may result. Furthermore, a burn may be caused if a human body comes in contact with the piping.

Be sure to use wet cloth on gas pipe insulation, when removing the cap or also when brazing with accessory pipe. If wet cloth is not used, insulation may catch fire so to prevent this situation/condition wet cloth must be used.

Perform nitrogen substituent or apply nitrogen into the refrigerant piping (see NOTE 1) in the case of refrigerant piping brazing (see NOTE 2). Then perform the flare connection of the indoor unit. (Refer to Fig. 4)

Drain piping connections
Do not connect the drain piping directly to sewage pipes that smell of ammonia. The ammonia in the sewage might enter the indoor unit through the drain pipes and corrode the heat exchanger.

8. DUCT WORK

Pay utmost attention to the following items and conduct the ductwork.

- Check that the duct will not be in excess of the setting range of external static pressure for the unit. (Refer to the technical datasheet for the setting range. Each model has each setting range of external static pressure.)
- Attach a canvas duct each to the air outlet and air inlet so that the vibration of the equipment will not be transmitted to the duct or ceiling.
- If the metal duct pass through a metal latch, wire latch, or metal plate of a wooden structure, separate the duct and wall electrically.
- Be sure to heat insulate the duct for the prevention of dew condensation. (Material: Glass wool or styrene foam; Thickness: 25 mm)

NOTE: 1. At the time of brazing, set the pressure of nitrogen to approximately 0.02 MPa (close to the pressure of a breeze coming in contact with the cheek) with a decompression valve. 2. Do not use flux at the time of brazing and connecting the refrigerant piping. Use a copper phosphorus brazing alloy BCU-P-2: JIS Z 3264/BCu 93P-710795: ISO3677), which does not require flux, for brazing.

2-3 OPTIONAL ACCESSORIES

- A wired remote controller is necessary for this unit separately.

NOTE: If you wish to use a remote controller that is not listed in Table 1, select a suitable remote controller after consulting catalogs and technical materials.

FOR THE FOLLOWING ITEMS, TAKE SPECIAL CARE DURING CONSTRUCTION AND CHECK AFTER INSTALLATION IS FINISHED.

a. Items to be checked after completion of work

Items to be checked	If not properly done, what is likely to occur.	Check
Are the indoor and outdoor unit fixed firmly?	The units may drop, vibrate or make noise.	
Was the installation of the outdoor unit completed?	The unit may malfunction or the components may burn out.	
Is the gas leak test finished?	No cooling or heating.	
Is the unit fully insulated? (Refrigerant piping, drain piping and duct)	Condensate water may drip.	
Does drainage flow smoothly?	Condensate water may drip.	
Does the power supply voltage conform to the indication on the name plate?	The unit may malfunction or the components may burn out.	
Are wiring and piping correct?	The unit may malfunction or the components may burn out.	
Is the air conditioner properly grounded?	Dangerous in case of current leakage.	
Is wiring size according to specifications?	The unit may malfunction or the components burn out.	
Is something blocking the air outlet or inlet of either the indoor or outdoor units?	No cooling or heating.	
Did you set the external static pressure?	No cooling or heating.	
Are refrigerant piping length and additional refrigerant charge noted down?	The refrigerant charge in the system is not clear.	
Did you check that no wiring connection screws were loose?	Electric shock or fire.	

Also review the "SAFETY PRECAUTIONS".

b. Items to be checked at the time of delivery

Items to be checked	Check
Are you sure the control box lid, air filter, air inlet grille and air outlet grille are mounted?	
Did you explain about operations while showing the operation manual to your customer?	
Did you deliver the operation manual along with the installation manual to the customer?	
Did you explain the customer the handling and cleaning methods of the field supplies (e.g., the air filter, air inlet grille and air outlet grille)?	
Did you deliver instruction manual, if any, for the field supplies to the customer?	

4. PREPARING BEFORE INSTALLATION

(1) Relative positions of indoor unit and suspension bolt.

(2) Mount the canvas ducts to the air outlet and inlet so that the vibration of the air conditioner will not be transmitted to the duct or ceiling. Apply a sound-absorbing material (insulation material) to the inner wall of the duct and vibration insulation rubber to the hanging bolts (refer to 8. DUCT WORK).

5. INDOOR UNIT INSTALLATION

Installing optional accessories before installing the indoor unit is easier. As for the parts to be used for installation work, be sure to use the provided accessories and specified parts designated by our company.

(1) Fix the hanger bracket to the suspension bolt. Tighten both upper and lower nuts firmly using washers.

(2) Tighten from above and below (Double nut).

9. ELECTRIC WIRING WORK

9-1 GENERAL INSTRUCTIONS

Shut off the power before starting any work.

- All field supplied parts and materials and electric works must conform to local codes.
- Use copper wire only.
- For electric wiring work, refer to "Wiring diagram label" attached to the control box lid.
- For remote controller wiring details, refer to the installation manual attached to the remote controller.
- All wiring must be performed by an authorized electrician.
- This system consists of multiple indoor units. Mark each indoor unit as unit A, unit B..., and be sure the terminal board wiring to the outdoor unit and BS unit are properly matched. If wiring and piping between the outdoor unit and an indoor unit are mismatched, the system may cause a malfunction.
- A circuit breaker capable of shutting down power supply to the entire system must be installed.
- Refer to the installation manual attached to the outdoor unit for the size of power supply wiring connected to the outdoor unit, the capacity of the circuit breaker and switch, and wiring instructions.
- Be sure to ground the air conditioner.
- Do not connect the ground wire to gas and water pipes, lightning rods, or telephone ground wires.
- Gas pipes: might cause explosions or fire if gas leaks.
- Water pipes: no grounding effect if hard vinyl piping is used.
- Telephone ground wires or lightning rods: might cause abnormally high electric potential in the ground during lightning storms.

9-2 ELECTRIC CHARACTERISTICS

Model	Hz	Volts	Voltage range	MCA	MFA	kW	FLA
FXMQ125NFRV16	50	230	Max. 263 Min. 207	8.2	15	0.750H	6.3
8.2				15	0.750H	6.3	
8.2				15	0.750H	6.3	

MCA: Min. Circuit Amps (A); MFA: Max. Fuse Amps (A)
kW: Fan Motor Rated Output (kW); FLA: Full Load Amps (A)

9-3 SPECIFICATIONS FOR FIELD SUPPLIED FUSES AND WIRE

Model	Field fuse	Wire	Size	Wire	Size
FXMQ125NFRV16 FXMQ200NFRV16 FXMQ250NFRV16	15A	H05VH-USG	Size must comply with local codes.	Shielded wire (2 wire)	0.75 mm ² 1.25 mm ²

NOTE: 1. Allowable length of transmission wiring between indoor/outdoor units and between the indoor unit and the remote controller is as follows. (1) Outdoor unit - Indoor unit: Max. 1000 m (Total wiring length: 2000 m) (2) Indoor unit - Remote controller: Max. 500 m 2. Shows only in case of protected pipes. Use H07RN-F in case of no protection. 3. Vinyl cord with sheath or cable (insulated thickness: 1mm or more)

10. WIRING EXAMPLE AND HOW TO SET THE REMOTE CONTROLLER

10-1 HOW TO CONNECT WIRINGS

(Remove the control box lid and wire as shown in the figure below.)

10-2 WIRING EXAMPLE

Install an earth leakage breaker. The installation of an earth leakage breaker is imperative for the prevention of electric shocks and fire accidents.

Fit the power supply wiring of each unit with a switch and fuse as shown in the drawing.

COMPLETE SYSTEM EXAMPLE (3 SYSTEMS)

Terminal	Size	Tightening torque
Terminal block for remote controller (6P)	M3.5	0.79 - 0.97 N·m
Power supply terminal block (3P)	M5	2.39 - 2.91 N·m
Ground terminal	M5	3.02 - 4.08 N·m

10. WIRING EXAMPLE AND HOW TO SET THE REMOTE CONTROLLER

10-1 HOW TO CONNECT WIRINGS

(Remove the control box lid and wire as shown in the figure below.)

10-2 WIRING EXAMPLE

Install an earth leakage breaker. The installation of an earth leakage breaker is imperative for the prevention of electric shocks and fire accidents.

Fit the power supply wiring of each unit with a switch and fuse as shown in the drawing.

COMPLETE SYSTEM EXAMPLE (3 SYSTEMS)

Terminal	Size	Tightening torque
Terminal block for remote controller (6P)	M3.5	0.79 - 0.97 N·m
Power supply terminal block (3P)	M5	2.39 - 2.91 N·m
Ground terminal	M5	3.02 - 4.08 N·m

1. When using 1 remote controller for 1 indoor unit. (Normal operation)

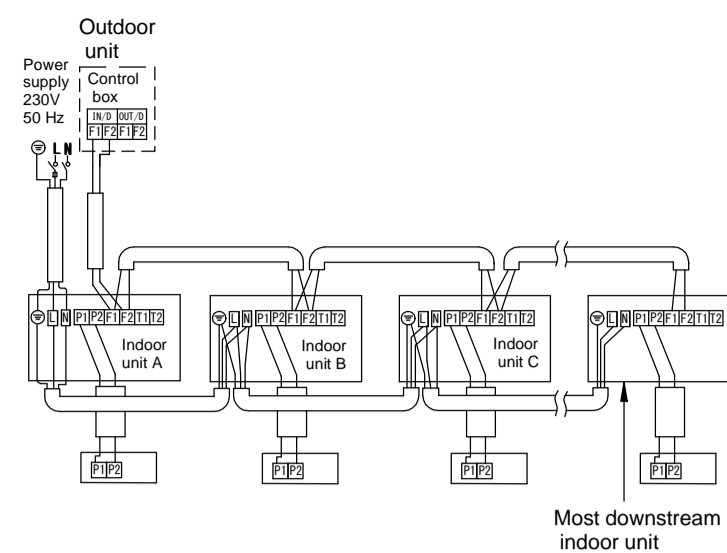

2. For group control or use with 2 remote controllers

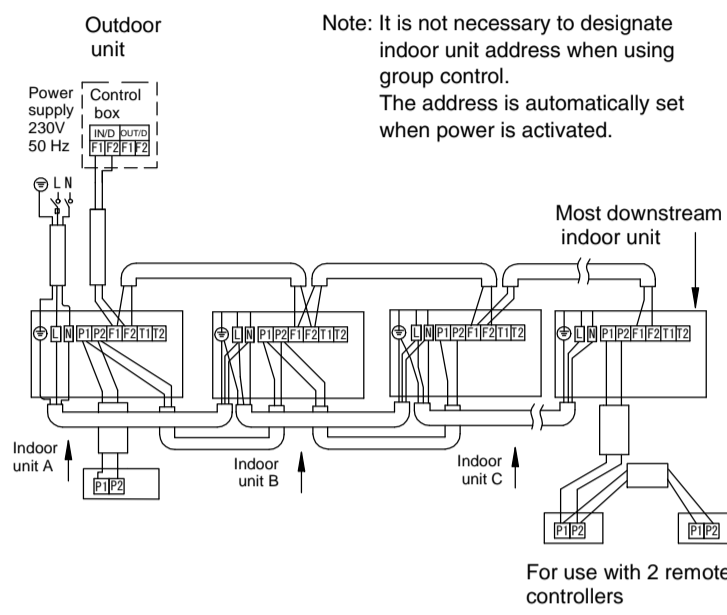

Fig. 5

PRECAUTIONS

- If no earth leakage breaker is required, install a breaker or load switch with a fuse for the wiring. If an earth leakage breaker is required, make sure that the earth leakage breaker is designed to protect the air conditioner from ground faults, overloads, and short-circuiting.
- The remote controller wiring (P1 and P2) and transmission wiring (F1 and F2) have no polarity.

10-3 CONTROL BY 2 REMOTE CONTROLLERS (Controlling 1 indoor unit by 2 remote controllers)

- Set one of the remote controllers to main and the other to sub in the case of remote control with two remote controllers.

Switching Main/Sub

- Insert a screwdriver into the clearance between the grooves of the lower casing and the upper casing to remove the upper casing. (2 grooves) (The remote controller PCB is attached to the upper casing.)

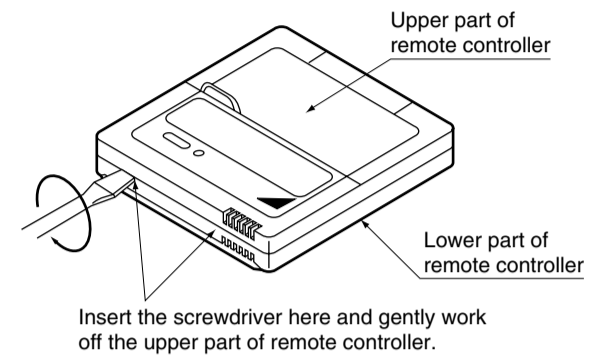

Insert the screwdriver here and gently work off the upper part of remote controller.

- Set the main/sub switch on one of the remote controller PCBs to sub. (Keep the switch of the other remote controller PCB set to main.)

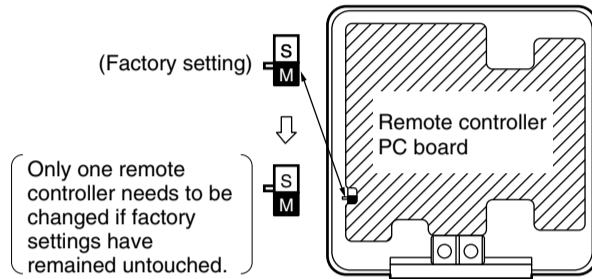

Wiring Method (See 10-1.)

- Remove the electric parts box lid.
- Add the second remote controller (slave) to the transmission terminal block (X2M/P1, P2) in the electric parts box. (There is no polarity.) (Refer to Fig. 5 and 9-3.)

10-4 COMPUTERISED CONTROL (FORCED OFF AND ON/OFF OPERATION)

- Wire specifications and how to perform wiring
 - Connect the input from outside to terminals T1 and T2 of the terminal block for remote controller.

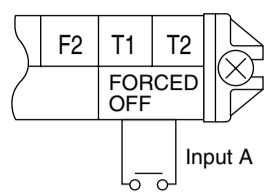

Wire specification	Sheathed vinyl cord or cable (2 wire)
Gauge	0.75 - 1.25 mm ²
Length	Max. 100 m
External terminal	Contact that can ensure the minimum applicable load of 15 V DC, 1 mA.

- Actuation

- The following table explains FORCED OFF and ON/OFF OPERATIONS in response to Input A.

FORCED OFF	ON/OFF OPERATION
Input "ON" stops operation (impossible by remote controllers.)	Input OFF → ON turns ON unit.
Input OFF enables control by remote controller.	Input ON → OFF turns OFF unit.

- How to select FORCED OFF and ON/OFF OPERATION
 - Turn the power on and then use the remote controller to select operation.

10-5 CENTRALIZED CONTROL

- For centralized control, it is necessary to designate the group No. For details, refer to the manual of each optional controllers for centralized control.

11. FIELD SETTING

NOTE

11-1 How to set

- Make sure the electric parts box lids are closed on the indoor and outdoor units.
- After the power is turned on, following the operation manual and designate the master remote controller using the remote controller.
 - When setting the unit, ask the customer which remote controller he wants to designate as the master remote controller.
 - See also the operation manual included with the outdoor unit.
- Field setting must be made from the remote controller in accordance with the installation condition.
 - Setting can be made by changing the "Mode No.", "FIRST CODE NO.", and "SECOND CODE NO.".
 - Set the remote controller to the field set mode. For details, refer to the "HOW TO SET IN THE FIELD", in the remote controller manual. Lastly, make sure the customer keeps the "FIELD SETTING" manual, along with the operation manual, in a safe place.

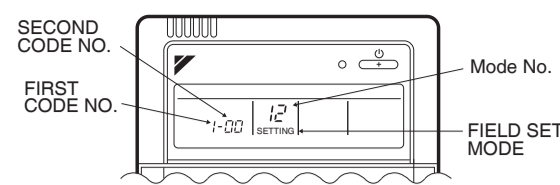

11-2 How to select FORCED OFF and ON/OFF OPERATION

- When in the field set mode, select mode No. 12, then set the first code (switch) No. to "1". Then set second code (position) No. to "01" for FORCED OFF and "02" for ON/OFF OPERATION. (FORCED OFF at factory set)

11-3 Setting air filter sign

- Remote controllers are equipped with liquid crystal display air filter signs to display the time to clean air filters.
- Change the SECOND CODE NO. according to Table 5 depending on the amount of dirt or dust in the room. (SECOND CODE NO. is factory set to "01" for filter contamination-light)

Setting	Spacing time of display air filter sign (long life type)	Mode No.	FIRST CODE NO.	SECOND CODE NO.
Air filter contamination-light	Approx. 2500 hrs	10 (20)	0	01
Air filter contamination-heavy	Approx. 1250 hrs			02

11-4 Setting air discharge temperature

- Change the SECOND CODE NO. according to Table 6 depending on user's need. (SECOND CODE NO. is set to "06" for cooling "08" for heating at factory set)

Mode No.	for cooling		for heating
	14 (24)	14 (24)	14 (24)
FIRST CODE NO.	3	4	
SECOND CODE NO.	01	13°C	18°C
	02	14°C	19°C
	03	15°C	20°C
	04	16°C	21°C
	05	17°C	22°C
	06	18°C	23°C
	07	19°C	24°C
	08	20°C	25°C
	09	21°C	26°C
	10	22°C	27°C
	11	23°C	28°C
	12	24°C	29°C
	13	25°C	30°C

NOTE

Air discharge temperature is not displayed on remote controller.

12. TEST OPERATION

Refer to the installation manual of the outdoor unit.

- The operation lamp of the remote controller will flash when any malfunction occurs. Check the malfunction code on the liquid crystal display to identify the point of trouble. An explanation of malfunction codes and the corresponding trouble is provided in "CAUTION FOR SERVICING" of the outdoor unit. If any of the items in Table 4 are displayed, there may be a problem with the wiring or power, so check the wiring again.

Table 4

Remote control display	Content
"E" is lit up	<ul style="list-style-type: none"> There is a short circuit at the FORCED OFF terminals (T1, T2)
"U4" is lit up "UH" is lit up	<ul style="list-style-type: none"> The power on the outdoor unit is off. The outdoor unit has not been wired for power supply. Incorrect wiring for the transmission wiring and / or FORCED OFF wiring.
No display	<ul style="list-style-type: none"> The power on the indoor unit is off. The indoor unit has not been wired for power supply. Incorrect wiring for the remote controller wiring, the transmission wiring and / or the FORCED OFF wiring.

WARNING

If interior finish work is continuing on completion of the test operation of the air conditioner, explain the customer not to operate the air conditioner until the interior finish work is completed for the protection of the air conditioner. Otherwise, substances that will be generated from interior finish work materials, such as paint and adhesive agents, may contaminate the air conditioner.

DAIKIN AIRCONDITIONING INDIA PVT. LTD.

Head office:
12th Floor, Building No.9, Tower A,
DLF Cyber City, DLF Phase-III,
Gurgaon-122 002, Haryana, India
www.daikinindia.com

DAIKIN

OPERATION MANUAL

***VRV* Outdoor - Air Processing Unit**

MODELS

FXMQ125NFRV16

FXMQ200NFRV16

FXMQ250NFRV16

Thank you for purchasing Daikin products.
Carefully read this operation manual
before using the unit. It will tell you how to
use the unit properly and help you if any
trouble occurs. After reading the manual,
file it away for future reference.

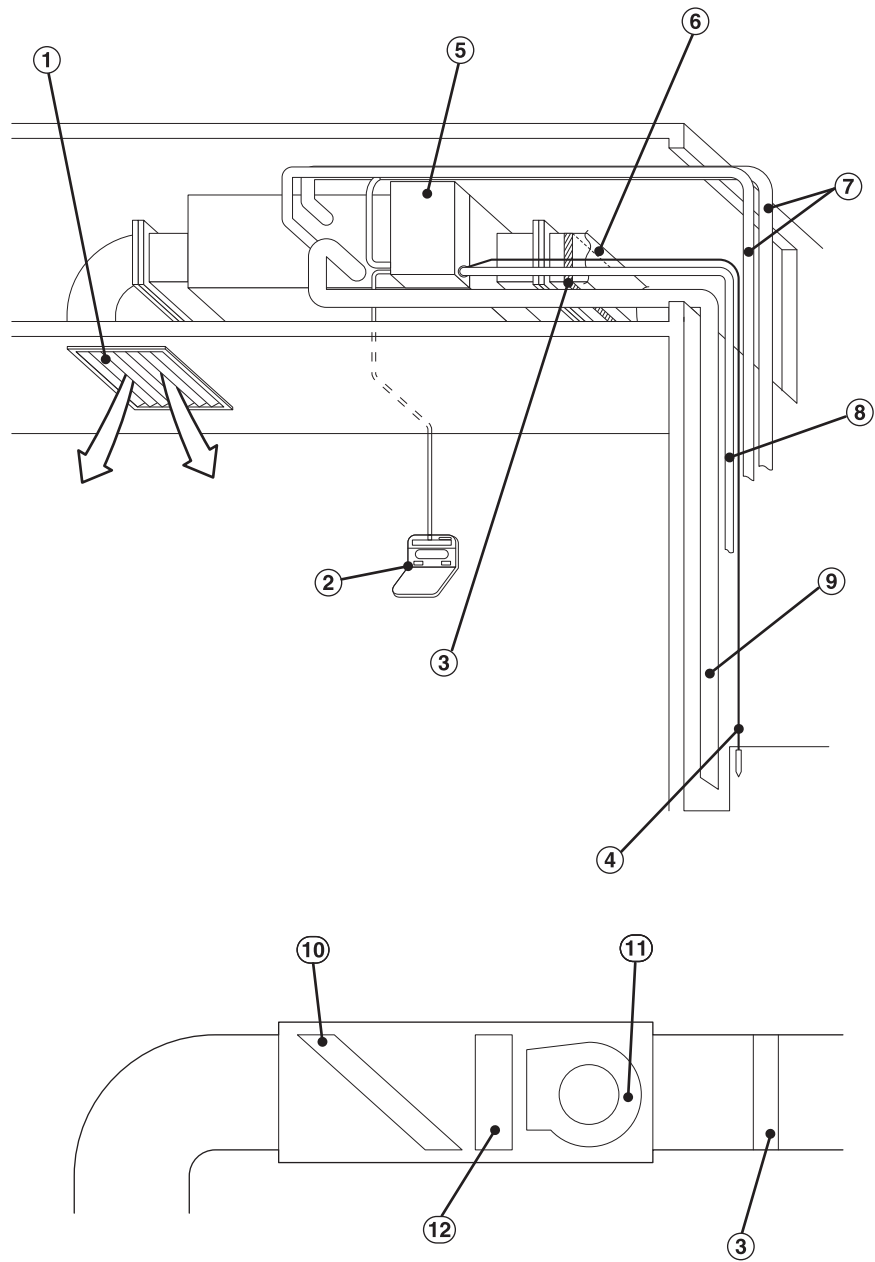

1

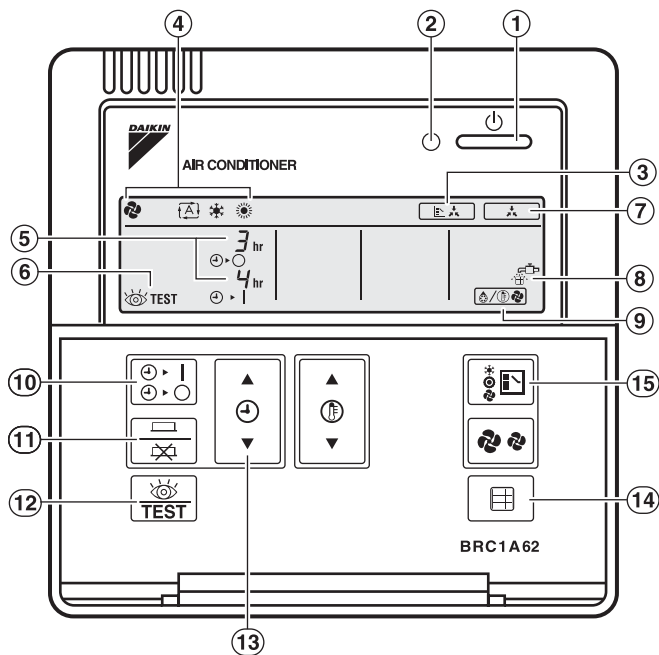

2

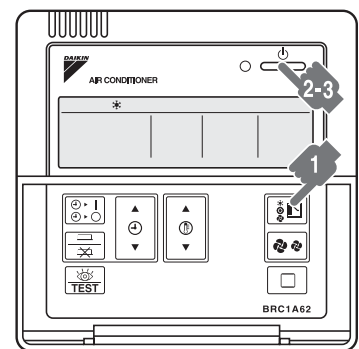

3

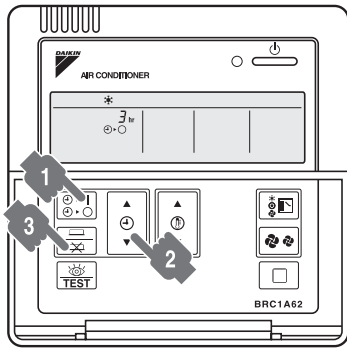

4

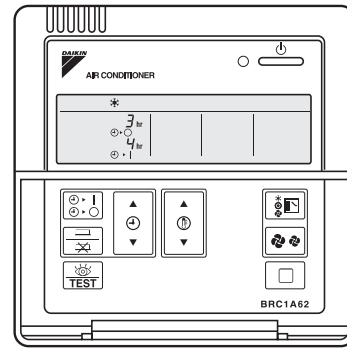

5

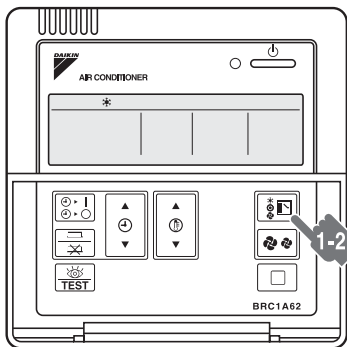

6

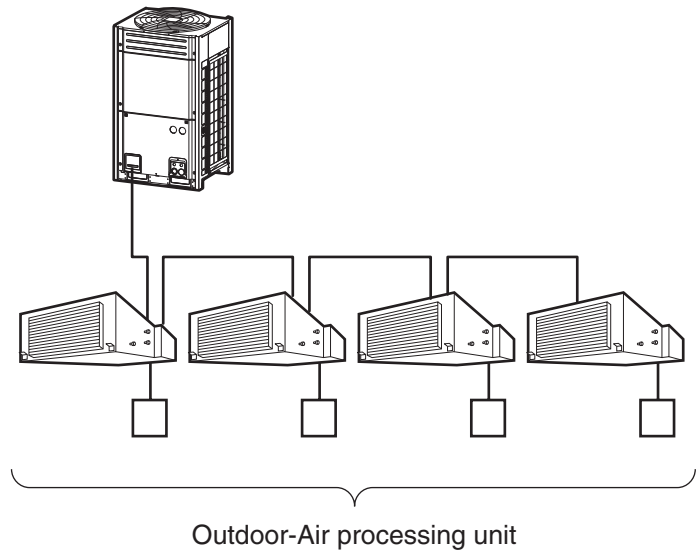

7

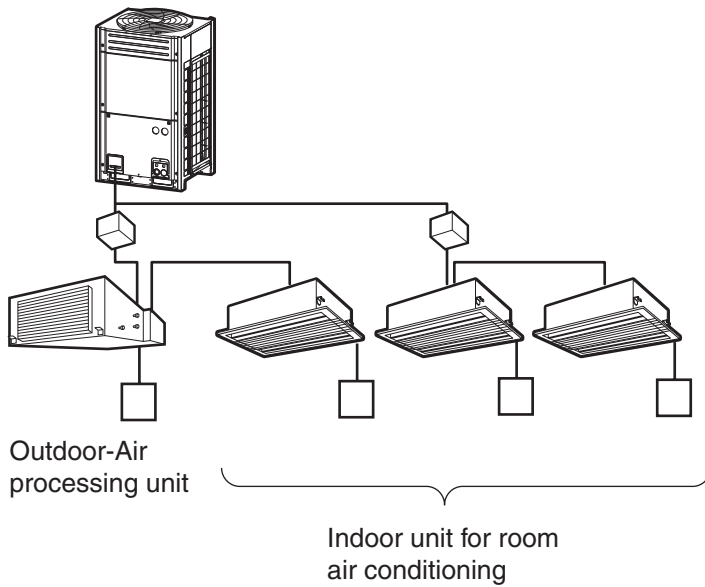

8

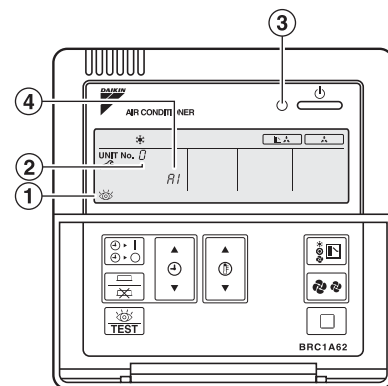

9

CONTENTS

1. SAFETY PRECAUTIONS	1
2. OUTDOOR-AIR PROCESSING UNIT : NAME OF EACH PART	3
3. REMOTE CONTROLLER : NAME AND FUNCTION OF EACH SWITCH AND DISPLAY	3
4. OPERATION RANGE.....	4
5. OPERATION PROCEDURE	4
6. OPTIMUM OPERATION	6
7. MAINTENANCE	6
8. FOLLOWING SYMPTOMS ARE NOT SYSTEM TROUBLES.....	7
9. TROUBLE SHOOTING	8

Important information regarding the refrigerant used

This product contains fluorinated greenhouse gases covered by the Kyoto Protocol.

Refrigerant type : R410A

GWP⁽¹⁾ value : 1975

⁽¹⁾GWP = Global Warming Potential

Periodical inspections for refrigerant leaks may be required depending on Indian or local legislation.

Please contact your local dealer for more information.

1. SAFETY PRECAUTIONS

To gain full advantage of the air conditioner's functions and to avoid malfunction due to mishandling, please read this operation manual carefully before use.

This product comes under the term "appliances not accessible to the general public".

This appliance is intended to be used by expert or trained users in shops, in light industry and or farms, or for commercial use by lay persons.

This appliance can be used by children aged from 8 years and above and persons with reduced physical, sensory or mental capabilities or lack of experience and knowledge if they have been given supervision or instruction concerning use of the appliance in a safe way and understand the hazards involved. Children shall not play with the appliance. Cleaning and user maintenance shall only be done by persons described in manual.

The appliance is not intended for use by unattended young children or persons who are incompetent to operate air conditioners.

It may result in injury or electric shocks.

- **This manual classifies the precautions into WARNINGS and CAUTIONS. Be sure to follow all the precautions below: They are all important for ensuring safety.**

 **WARNING** Indicates a potentially hazardous situation which, if not avoided, could result in either death or serious injury.

 **CAUTION** Indicates a potentially hazardous situation which, if not avoided, may result in minor or moderate injury. It may also be used to alert against unsafe practices.

- **After reading, keep this manual in a convenient place so that you can refer to it whenever necessary. If the equipment is transferred to a new user, be sure also to hand over the manual.**

WARNING

When the air conditioner is malfunctioning (giving off a burning odor, etc.), turn off the power to the air conditioner and contact your local dealer.

Continued operation under such circumstances may result in a failure, electric shocks or a fire.

Consult your local dealer regarding modification, repair and maintenance of the air conditioner.

Improper workmanship may result in water leakage, electric shocks or a fire.

Be sure to use fuses with the correct ampere reading.

Do not use improper fuses, copper or other wiring as a substitute, as this may result in electric shocks, a fire, injury or damage to the air conditioner.

Consult your local dealer if the air conditioner submerges owing to a natural disaster, such as a flood or typhoon.

Do not operate the air conditioner in that case, or otherwise a malfunction, electric shocks, or a fire may result.

Start or stop the air conditioner with the remote controller. Never use the power circuit breaker for this purpose.

Otherwise, it may cause a fire or water leakage. Furthermore, if an automatic restart control is provided against power failure and the power is recovered, the fan will rotate suddenly and may cause injury.

Do not use the air conditioner in the atmosphere contaminated with oil vapor, such as cooking oil or machine oil vapor.

Oil vapor may cause crack damage to the air conditioner, electric shocks, or a fire.

Do not use flammable materials (e.g., hairspray or insecticide) near the air conditioner.

Do not clean the air conditioner with organic solvents such as paint thinner.

The use of organic solvents may cause crack damage to the air conditioner, electric shocks, or a fire.

Do not use the air conditioner in places with excessive oily smoke, such as cooking rooms, or in places with flammable gas, corrosive gas, or metal dust.

Using the air conditioner in such places may cause a fire or air conditioner failures.

Beware of a fire in case of refrigerant leakage.

If the air conditioner is not operating correctly, i.e. not generating cool or warm air, refrigerant leakage could be the cause. Consult your local dealer for assistance. The refrigerant used for the air conditioner is safe and normally does not leak. However, if the refrigerant leaks and gets in contact with a naked burner, heater or cooker, it may generate hazardous compounds. Turn off the air conditioner and call your local dealer. Turn on the air conditioner after the qualified service person makes sure to confirm that the leakage is repaired.

Do not place objects, including rods, your fingers, etc., in the air inlet or outlet.

Injury may result due to contact with the air conditioner's highspeed fan blades.

Consult your local dealer regarding cleaning the inside of the air conditioner.

Improper cleaning may cause breakage of plastic parts, water leakage and other damage as well as electric shocks.

Be aware that prolonged, direct exposure to cool or warm air from the air conditioner, or to air that is too cool or too warm can be harmful to your physical condition and health.

Consult your local dealer about installation work.

Doing the work yourself may result in water leakage, electric shocks or a fire.

Contact professional personnel about attachment of accessories and be sure to use only accessories specified by the manufacturer.

If a defect results from your own workmanship, it may result in water leakage, electric shocks or a fire.

Consult your local dealer regarding relocation and reinstallation of the air conditioner.

Improper installation work may result in leakage, electric shocks or a fire.

Be sure to earth the air conditioner.

Do not earth the air conditioner to a utility piping, lightning conductor or telephone earth lead.

Imperfect earthing may result in electric shocks or a fire. A high surge current from lightning or other sources may cause damage to the air conditioner.

Be sure to install an earth leakage breaker.

Failure to install an earth leakage breaker may result in electric shocks or a fire.

Be sure to use a dedicated power supply for the air conditioner.

The use of any other power supply may cause heat generation, a fire, or air conditioner failures.

Consult your local dealer regarding what to do in case of refrigerant leakage.

When the air conditioner is installed in a small room, it is necessary to take proper measures so that the amount of any leaked refrigerant does not exceed the concentration limit in the event of a leakage. Otherwise, this may lead to an accident due to oxygen depletion.

 **CAUTION**

Children should be watched so that they do not play with the indoor unit or its remote controller.

Accidental operation by a child may result in injury or electric shocks.

Do not allow a child to mount on the outdoor unit or avoid placing any object on it.

Falling or tumbling may result in injury.

Do not let children play on or around the outdoor unit.

If they touch the unit carelessly, injury may be caused.

Be sure that children, plants or animals are not exposed directly to airflow from the indoor unit, as adverse effects may ensue.

Do not place flammable sprays or operate spray containers near the air conditioner as this may result in a fire.

Do not wash the air conditioner or the remote controller with water, as this may result in electric shocks or fire.

Do not place water containers (flower vases, etc.) on the indoor unit, as this may result in electric shocks or a fire.

Do not put flammable containers, such as spray cans, within 1 m from the air outlet.

The containers may explode because the warm air from the indoor or outdoor unit will affect them.

Turn off the power when the air conditioner is not used for long periods of time.

Otherwise, the air conditioner may get hot or catch on a fire due to dust accumulation.

Do not place objects in direct proximity of the outdoor unit and do not let leaves and other debris accumulate around the unit.

Leaves are a hotbed for small animals which can enter the unit. Once entered in the unit, such animals can cause malfunctions, smoke or a fire when making contact with electrical parts.

Before cleaning, be sure to stop the air conditioner operation, turn the power circuit breaker off. Otherwise, an electric shocks and injury may result.

To avoid electric shocks, do not operate with wet hands.

Never touch the internal parts of the remote controller.

Touching certain internal parts will cause electric shocks and damage to the remote controller. Consult your local dealer about checking and adjustment of internal parts.

To avoid oxygen deficiency, ensure that the room is adequately ventilated if equipment such as a burner is used together with the air conditioner.

Do not leave the remote controller wherever there is a risk of wetting.

If water gets into the remote controller there is a risk of electrical leakage and damage to electronic components.

Watch your steps at the time of air filter cleaning or inspection.

High-place work is required, to which utmost attention must be paid.

If the scaffold is unstable, you may fall or topple down, thus causing injury.

Do not remove the outdoor unit's outlet side grille. The grille protects against the unit's high speed fan, which may cause injury.

To avoid injury, do not touch the air inlet or aluminum fins of the air conditioner.

Do not place objects that are susceptible to moisture directly beneath the indoor or outdoor units.

Under certain conditions, condensation on the unit or refrigerant piping, air filter dirt or drain blockage may cause dripping, resulting in fouling or failure of the object concerned.

Do not place heaters directly below the indoor unit, as resulting heat can cause deformation.

Do not place appliances that produce naked flames in places exposed to the airflow from the air conditioner as this may impair combustion of the burner.

Do not block either air inlets or outlets.

Impaired airflow may result in insufficient performance or trouble.

Do not use the air conditioner for purposes other than those for which it is intended.

Do not use the air conditioner for cooling precision instruments, food, plants, animals or works of art as this may adversely affect the performance, quality and/or longevity of the object concerned.

Do not install the air conditioner at any place where there is a danger of flammable gas leakage.

In the event of a gas leakage, build-up of gas near the air conditioner may result in a fire.

Carry out drain piping properly to ensure complete drainage.

If drain piping is not carried out properly, drain will not flow out. Then, dirt and debris may be accumulated in the drain piping and may cause water leakage. If it occurs, stop the air conditioner and call your local dealer for assistance.

NOTE TO SERVICE PERSONNEL

⚠ WARNING

- **Before inspection (of the electrical parts box, fan motor, auxiliary electric heater, drain pump etc.) ensure the power to the air-conditioner and auxiliary heater is disconnected to avoid electric shock.**
- **When cleaning the heat exchanger, remove the electrical parts box, fan motor, auxiliary electric heater and drain pump. Water or detergent may deteriorate the insulation of the electrical components, resulting in component failure.**

⚠ CAUTION

- **Removing the panel.**

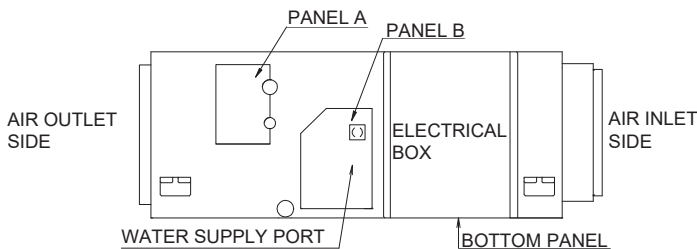

- **See below and remove the appropriate panel depending on the purpose of the work to be done.**

The purpose of the work to be done	Panel
To check the electrical parts of the heat exchanger.	Panel B+A
To service the fan assy.	Bottom Panel
To check the drainage.	Panel B
To clean the drain pan.	Panel A + B

- * Do not remove the panel except when necessary.
- * Do not remove the panel on the opposite side to this one.

2. OUTDOOR-AIR PROCESSING UNIT : NAME OF EACH PART (Refer to figure 1)

1. Air outlet
2. Remote controller
3. Air filter (PM10 + PM50)
4. Ground wire
5. Electric parts box
6. Outdoor air inlet
7. Refrigerant pipe and interconnecting wire
8. Power wire
9. Drain pipe
10. Heat exchanger
11. Fan
12. Drain pump kit (Optional accessory)

3. REMOTE CONTROLLER : NAME AND FUNCTION OF EACH SWITCH AND DISPLAY (Refer to figure 2)

1. **On/off button**
Press the button and the system will start. Press the button again and the system will stop.
2. **Operation lamp (red)**
The lamp lights up during operation.
3. **Display “” (changeover under control)**
It is impossible to change heat/cool with the remote controller when this icon is displayed.
4. **Display “” “” “” “” (operation mode)**
This display shows the current operation mode.
5. **Display “” (programmed time)**
This display shows the programmed time of the system start or stop.
6. **Display “ TEST” (inspection/test operation)**
When the inspection/test operation button is pressed, the display shows the mode in which the system actually is.
7. **Display “” (under centralized control)**
When this display shows, the system is under centralized control.
(This is not a standard specification.)

8. Display “” (time to clean air filter)

When this display shows, it is the time to clean air filter.

9. Display “/Hot start”

Refer to the chapter “OPERATION PROCEDURE - EXPLANATION OF HEATING OPERATION.”

10. Timer mode start/stop button

Refer to the chapter “OPERATION PROCEDURE - PROGRAMMING START AND STOP OF THE SYSTEM WITH TIMER.”

11. Timer on/off button

Refer to the chapter “OPERATION PROCEDURE - PROGRAMMING START AND STOP OF THE SYSTEM WITH TIMER.”

12. Inspection/test operation button

This button is only used by qualified service persons for maintenance purposes.

13. Programming time button

Use this button for programming start and/or stop time.

14. Filter sign reset button

Refer to the chapter “MAINTENANCE”.

15. Operation mode selector button

Press this button to select the operation mode of your preference.

NOTE

- In contradistinction to actual operating situations, the display on figure 2 shows all possible indications.
- If the display “” (time to clean air filter) shows, clean the air filter as explained in the chapter “MAINTENANCE”. After cleaning and reinstalling the air filter, press the filter sign reset button on the remote controller. The filter sign lamp on the display will go out.
- This operation manual is for the Outdoor-Air Processing Unit.
See the outdoor unit’s operation manual for details on the indoor unit for room air conditioning.

4. OPERATION RANGE

Use the system in the following temperature and humidity ranges for safe and effective operation.

COOLING [°C]

OUTDOOR TEMPERATURE		
	TEMPERATURE	HUMIDITY
DB	19 to 43 (Note)	30% to 90% (Long time operation in a humidity over 90% may cause condensation on the unit and dripping.)
WB	32 or below	

DB: Dry bulb temperature

WB: Wet bulb temperature

NOTE

- The FAN OPERATION mode is set automatically for DB temperature of 19°C and below.
- Do not use the COOLING OPERATION or FAN OPERATION modes when outdoor temperature is 5°C or lower. The unit will stop running to protect itself against cold damage. In such case, set the AUTOMATIC OPERATION or HEATING OPERATION mode.

HEATING [°C]

OUTDOOR TEMPERATURE	
DB	-5 to 15 (Note)

DB: Dry bulb temperature

NOTE



- The FAN OPERATION mode is set automatically for DB temperature of 15°C and above.

If the temperature or the humidity is beyond these conditions, safety devices may work and the unit may not operate.

5. OPERATION PROCEDURE

- To protect the unit, turn on the power supply 6 hours before operation.
- If the power supply is turned off during operation, operation will restart automatically after the power turns back on again.
- This unit cannot control room temperature. If room temperature control is needed, install it together with the indoor unit for room air conditioning.
- This unit is designed to operate so that the temperature of the outlet air is as close as possible to the set temperature.
This may not be possible, however, due to the outdoor air temperature.
When shipped from the factory, the set temperature is set at 18°C for cooling and 25°C for heating. The set temperature can be changed between 13 and 25°C for cooling / 18 and 30°C for heating by local setting from remote controller. About set temperature or how to change it, ask your dealer. The set temperature will not be displayed on the remote controller.





5-1 COOLING, HEATING, AUTOMATIC, AND FAN ONLY OPERATION (Refer to figure 3)

- Changeover cannot be made with a remote controller whose display shows “” (changeover under control).
- When the display “” (changeover under control) flashes, refer to the chapter “5-3 SETTING THE MASTER REMOTE CONTROLLER”.

- The fan may keep on running for about 1 minute after the heating operation stops.
- The fan may stop immediately. This is not a malfunction.

Starting the system

- 1 Press the operation mode selector button several times and select the operation mode of your choice;

- “” Cooling operation
- “” Heating operation
- “” Automatic operation
- “” Fan only operation

NOTE

- Cooling / Heating operation
Outdoor air is cooled or warmed and brought indoors.
- Automatic operation
In this operation mode, cool/heat changeover is automatically conducted.
- Fan only operation
Outdoor air is brought indoors as is it.

- 2 Press the on/off button.
The operation lamp lights up and the system starts operation.

Stopping the system

- 3 Press the on/off button once again.
The operation lamp goes off and the system stops operation.

NOTE

- Do not turn off the power supply immediately after the unit stops, wait for at least 5 minutes.

EXPLANATION OF HEATING OPERATION



Defrost operation

- In heating operation, freezing of the outdoor unit coil increases. Heating capability decreases and the system goes into defrost operation.
- The indoor unit fan stops and the remote controller displays “”.
- After maximum 12 minutes of defrost operation, the system returns to heating operation again.



Hot start

- In order to prevent cold air from blowing out of an indoor unit at the start of heating operation, the indoor fan is automatically stopped. The display of the remote controller shows “”.

5-2 PROGRAMMING START AND STOP OF THE SYSTEM WITH TIMER (Refer to figure 4)

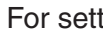

- The timer is operated in the following two ways.
Programming the stop time “” : The system stops operating after the set time has elapsed.
Programming the start time “” : The system starts operating after the set time has elapsed.
- The timer can be programmed for a maximum of 72 hours.
- The start and the stop time can be simultaneously programmed.

- 1 Press the timer mode start/stop button several times and select the mode on the display. The display flashes.

- For setting the timer stop “”
- For setting the timer start “”

- 2 Press the programming time button and set the time for stopping or starting the system.

-  Each time this button is pressed, the time advances or goes backward by 1 hour.

- 3 Press the timer on/off button.
The timer setting procedure ends. The display “” or “” changes from flashing light to constant light.

NOTE

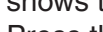
- When setting the timer stop and start at the same time, repeat the above procedure (from “” to “”) once again.
- After the timer is programmed, the display shows the remaining time.
- Press the timer on/off button once again to cancel programming. The display vanishes.

For example: (Refer to figure 5)

When the timer is programmed to stop the system after 3 hours and start the system after 4 hours, the system will stop after 3 hours and start 1 hour later.

5-3 SETTING THE MASTER REMOTE CONTROLLER (Refer to figure 6)

- When the system is installed as shown in figure 7 and 8, it is necessary to designate one of the remote controllers as the master remote controller.
- When one outdoor unit is connected with several outdoor-air processing units, designate one of the remote controllers as the master remote controller. (Refer to figure 7)



- When one outdoor unit is connected with outdoor-air processing units and indoor units for room air conditioning, designate one of the remote controllers of the indoor units as the master remote controller. **(Refer to figure 8)**

Otherwise, operation of system will be changed by outdoor air condition during automatic operation.

- Only the master remote controller can select heating, cooling or automatic (Only if the remote controller of outdoor air processing unit is designated as the master remote controller.) operation.
- The displays of slave remote controllers show “” (changeover under control) and they automatically follow the operation mode directed by the master remote controller.
- However, it is possible to change to fan only operation with slave remote controllers.

How to designate the master remote controller (Refer to figure 6)

1 Press the operation mode selector button of the current master remote controller for 4 seconds. The display showing “” (changeover under control) of all slave remote controllers connected to the same outdoor unit flashes.

2 Press the operation mode selector button of the controller that you wish to designate as the master remote controller. Then designation is completed. This remote controller is designated as the master remote controller and the display showing “” (changeover under control) vanishes. The displays of other remote controllers show “” (changeover under control).

5-4 PRECAUTIONS FOR GROUP CONTROL SYSTEM OR TWO REMOTE CONTROLLERS CONTROL SYSTEM

This system provides two other control systems beside individual control (one remote controller controls one indoor unit) system. Confirm the following if your unit is of the following control system type.

- **Group control system**
One remote controller controls up to 16 indoor units. All indoor units are equally set.
- **Two remote controllers control system**
Two remote controllers control one indoor unit (in case of group control system, one group of indoor units). The unit is individually operated.

NOTE

- Contact your Daikin dealer in case of changing the combination or setting of group control and two remote controllers control systems.

6. OPTIMUM OPERATION

Observe the following precautions to ensure the system operates properly.

- Adjust the air outlet properly and avoid direct air flow to room inhabitants.
- Adjust the room temperature properly for a comfortable environment. Avoid excessive heating or cooling.
- Prevent direct sunlight from entering a room during cooling operation by using curtains or blinds.
- Ventilate often.
Extended use requires special attention to ventilation.
- Keep doors and windows closed. If the doors and windows remain open, air will flow out of your room causing a decrease in the cooling or heating effect.
- Never place objects near the air inlet or the air outlet of the unit. It may cause deterioration in the effect or stop the operation.
- Turn off the power supply to the unit when the unit is not used for longer periods of time. If the switch is on, it uses electricity. Before restarting the unit, turn on the power supply 6 hours before operation to ensure smooth running. (Refer to the chapter “OPERATION PROCEDURE”.)
- When the display shows “” (time to clean the air filter), ask a qualified service person to clean the filters. (Refer to the chapter “MAINTENANCE”.)
- Keep the indoor unit and remote controller at least 1 m away from televisions, radios, stereos, and other similar equipment.
Failing to do so may cause static or distorted pictures.
- It takes time for the room temperature to reach the set temperature.
We recommend starting the operation in advance using timer operation.

7. MAINTENANCE

— WARNING —

- ONLY A QUALIFIED SERVICE PERSON IS ALLOWED TO PERFORM MAINTENANCE.
- BEFORE OBTAINING ACCESS TO TERMINAL DEVICES, ALL POWER SUPPLY CIRCUITS MUST BE INTERRUPTED.
- DO NOT USE WATER OR AIR OF 50°C OR HIGHER FOR CLEANING AIR FILTERS.

7-1 HOW TO CLEAN THE AIR FILTER

Clean the air filter when the display shows “” (time to clean air filter).

Increase the frequency of cleaning if the unit is installed in a room where the air is extremely contaminated.

(As a yardstick for regulating yourself, consider cleaning the filter.)

1. Remove the air filters.

2. Clean the air filter.

Use vacuum cleaner **A)** or wash the air filter with water **B)**.

A) Using a vacuum cleaner.



B) Washing with water.

To clean the air filter, use soft brush and neutral detergent.

Remove water and dry in the shade after cleaning.



3. Fix the air filter.

4. Press the FILTER SIGN RESET BUTTON on the remote controller.

The display “” (time to clean air filter) vanishes.

About other air filter

Clean the air filter by suitable method in the filter.

NOTE

- Do not remove the air filter except when cleaning. Unnecessary handling may damage the filter.

HOW TO CLEAN AIR OUTLET

1. Clean with soft cloth.

2. When it is difficult to remove stains, use water or neutral detergent.

NOTE

- Do not use gasoline, benzene, thinner, polishing powder, liquid insecticide. It may cause discolouring or warping.
- Do not let the unit get wet. It may cause an electric shock or a fire.

8. FOLLOWING SYMPTOMS ARE NOT SYSTEM TROUBLES

8-1 THE SYSTEM DOES NOT OPERATE

- **The system does not start immediately after the ON/OFF button on the remote controller is pushed.**

If the operation lamp lights, the system is in normal condition.

To prevent overloading of the compressor motor, the system starts 5 minutes after it is turned ON again in case it was turned OFF just before. The same starting delay occurs after the operation mode selector button was used.

- **If the display shows “” (under centralized control) and pressing the operation button causes the display to blink for a few seconds.**

This indicates that the central device is controlling the unit.

The blinking display indicates that the remote controller cannot be used.

- **The system does not start immediately after the power supply is turned on.**

Wait for one minute until the micro computer is prepared for operation.

8-2 COOL/HEAT CANNOT BE CHANGED OVER

- **When the display shows “” (changeover under control), it shows that this is a slave remote controller.**

- **When the cool/heat changeover remote control switch is installed and the display shows “” (changeover under control).**

This is because cool/heat changeover is controlled by the cool/heat changeover remote control switch. Ask your Daikin dealer where the remote control switch is installed.

8-3 FAN OPERATION IS POSSIBLE, BUT COOLING AND HEATING DO NOT WORK

- **When the outdoor temperature exceeds the range of use conditions, the unit automatically changes into fan mode from cooling or heating modes.**

8-4 NO AIR COMES OUT

- **The outdoor temperature has dropped to 0°C or lower while in “cooling” or “fan” modes.** The fan automatically stops due to the outdoor air temperature.

8-5 WHITE MIST COMES OUT OF A UNIT

Outdoor-air processing unit

- **When humidity is high during cooling operation.**

If the interior of the unit is extremely contaminated, the temperature distribution inside the unit becomes uneven. It is necessary to clean the interior of the unit. Ask your Daikin dealer for details on cleaning the unit. This operation requires a qualified service person.

- **Immediately after the cooling operation stops and if the outdoor temperature and humidity are low.**

This is because warm refrigerant gas flows back into the unit and generates steam.

Outdoor-air processing unit, outdoor unit

- **When the system is changed over to heating operation after defrost operation.**

Moisture generated by defrost becomes steam and is exhausted.

8-6 NOISE OF SYSTEM

Outdoor-air processing unit

- **A “zeen” sound is heard immediately after the power supply is turned on.**

The electronic expansion valve inside the unit starts working and makes the noise. Its volume will reduce in about one minute.

- **A continuous low “shah” sound is heard when the system is in cooling operation or at a stop.** When the drain pump (optional accessories) is in operation, this noise is heard.

- **A “pishi-pishi” squeaking sound is heard when the system stops after heating operation.** Expansion and contraction of plastic parts caused by temperature change make this noise.

- **A low “sah”, “choro-choro” sound is heard while the unit is stopped.** When the other unit is in operation, this noise is heard. In order to prevent oil and refrigerant from remaining in the system, a small amount of refrigerant is kept flowing.

Outdoor-air processing unit, outdoor unit

- **A continuous low hissing sound is heard when the system is in cooling or defrost operation.**

This is the sound of refrigerant gas flowing through the system.

- **A hissing sound which is heard at the start or immediately after stopping operation or defrost operation.**

This is the noise of refrigerant caused by flow stop or flow change.

Outdoor unit

- **When the tone of operating noise changes.** This noise is caused by the change of frequency.

8-7 DUST COMES OUT OF THE UNIT

- **When the unit is used after having stopped operating for a long time.**

This is because dust has gotten into the unit.

8-8 THE UNITS MAY GIVE OFF ODOURS

- **The unit may absorb the smell of outdoor air.**

8-9 THE OUTDOOR UNIT FAN DOES NOT SPIN

- **During operation.**

The speed of the fan is controlled in order to optimize product operation.

8-10 THE DISPLAY SHOWS “88”

- **This is the case immediately after the power supply is turned on and means that the remote controller is in normal condition. This continues for one minute.**

8-11 THE COMPRESSOR IN THE OUTDOOR UNIT DOES NOT STOP AFTER A SHORT HEATING OPERATION

- **This is to prevent oil and refrigerant from remaining in the compressor. The unit will stop after 5 to 10 minutes.**

8-12 THE INSIDE OF AN OUTDOOR UNIT IS WARM EVEN WHEN THE UNIT HAS STOPPED

- **This is because the crankcase heater is warming the compressor so that the compressor can start smoothly.**

9. TROUBLE SHOOTING

If one of the following malfunctions occur, take the measures shown below and contact your Daikin dealer.

The system must be repaired by a qualified service person.

- If a safety device such as a fuse, a breaker or an earth leakage breaker frequently actuates, or the ON/OFF switch does not properly work;
Measure: Turn off the power supply.
- If water leaks from unit;
Measure: Stop the operation.
- If the display “ TEST ”, the unit number and the operation lamp flash and the malfunction code appears; **(Refer to figure 9)**

1. Inspection display
2. Unit number in which a malfunction occurs
3. Operation lamp
4. Malfunction code

Measure: Notify your Daikin dealer and report the malfunction code.

If the system does not properly operate except for the above mentioned cases and none of the above mentioned malfunctions is evident, investigate the system according to the following procedures.

1. If the system does not operate at all;
 - Check if there is no power failure.
Wait until power is restored. If power failure occurs during operation, the system automatically restarts immediately after the power supply is recovered.
 - Check if no fuse has blown or breaker has worked.
Change the fuse or reset the breaker if necessary.
2. If the system goes into fan only operation, but as soon as it goes into heating or cooling operation, the system stops;
 - Check if air inlet or outlet of outdoor unit or outdoor-air processing unit is not blocked by obstacles.
Remove any obstacle and make it well-ventilated.
 - Check if the remote controller display shows “” (time to clean the air filter). (Refer to the chapter “MAINTENANCE”.)
3. The system operates but cooling or heating is insufficient;
 - Check if air inlet or outlet of outdoor or outdoor-air processing unit is not blocked by obstacles.
Remove any obstacle and make it well-ventilated.
 - Check if the air filter is not clogged. (Refer to the chapter “MAINTENANCE”.)

DAIKIN AIRCONDITIONING INDIA PVT. LTD.

Head office:

12th Floor, Building No.9,Tower A,
DLF Cyber City, DLF Phase-III,
Gurgaon-122 002, Haryana, India
www.daikinindia.com