

DAIKIN ROOM AIR CONDITIONER

# OPERATION MANUAL



## MODELS

**JTKJ35UV16WA****JTKJ50UV16VA****JTKJ60UV16UA**

# Features

## Enhanced comfort and energy savings



### INTELLIGENT EYE - ENERGY SAVER

The INTELLIGENT EYE sensor detects human movement in a room. If no one is in the room for more than 20 minutes, the operation automatically changes to energy saving operation.

▶ Page 24



### FLASH STREAMER

Streamer and filtration technologies remove airborne allergens such as mould, mites and pollen as well as adjuvant substances, viruses and bacteria. ▶ Page 18



### Wi-Fi

Lets you control your AC operation by simple voice command and user friendly App based upon Android and iOS platform. The voice assistant solution is based on most popular and commonly used voice recognition AI powered technology platform- Amazon Alexa & Google Home. ▶ Page 27

## Other functions



### COANDA

Directs airflow upward. This function prevents air from blowing directly at users. ▶ Page 14



### OUTDOOR UNIT QUIET

OUTDOOR UNIT QUIET operation assures a low noise level of the outdoor unit. This function is useful to maintain a quiet neighbourhood.

▶ Page 14

















# Contents

## ■ Read before Operation

|                                    |   |
|------------------------------------|---|
| Safety Precautions.....            | 3 |
| Name of Parts.....                 | 4 |
| Preparation before Operation ..... | 6 |

## ■ Operation

|  |    |
|--|----|
|  DRY · COOL · FAN Operation.....                            | 8  |
|  Adjusting the Temperature .....                            | 9  |
|  Checking the Inverter Output and Temperature Display ..... | 10 |
|  Adjusting the Airflow Direction .....                      | 11 |
|  Adjusting the Airflow Rate / SMELL PROOF Operation.....    | 12 |
|  POWER CHILL Operation .....                               | 13 |
|  COANDA/OUTDOOR UNIT QUIET Operation.....                 | 14 |
|  Variable.....  | 16 |
|  FLASH STREAMER AIR PURIFYING Operation .....             | 18 |
|  ON/OFF TIMER Operation .....                             | 19 |
|  GOOD SLEEP OFF TIMER Operation .....                     | 21 |
|  BACKLIGHT/CHILD LOCK.....                                | 22 |
|  LED / 7 SEGMENT BRIGHTNESS Control Operation.....        | 23 |
|  INTELLIGENT EYE Operations.....                          | 24 |
|  Wi-Fi/DEW CLEAN Operations.....                          | 27 |

## ■ Care

|                        |    |
|------------------------|----|
| Care and Cleaning..... | 31 |
|------------------------|----|

## ■ Troubleshooting

|                      |    |
|----------------------|----|
| Troubleshooting..... | 35 |
|----------------------|----|

# Safety Precautions

- Keep this manual where the user can easily find it.
- Read the precautions in this manual carefully before operating the unit.
- The precautions described herein are classified as WARNING and CAUTION. They both contain important information regarding safety. Be sure to observe all precautions without fail.

## WARNING

Failure to follow these instructions properly may result in personal injury or loss of life.

## CAUTION

Failure to follow these instructions properly may result in property damage or personal injury, which may be serious depending on the circumstances.



Never attempt.



Be sure to follow the instructions.





Be sure to establish an earth connection.

- After reading, keep this manual in a convenient place so that you can refer to it whenever necessary. If the equipment is transferred to a new user, be sure also to hand over the manual.

## WARNING

- To avoid fire, explosion or injury, do not operate the unit when harmful gases (e.g. flammable or corrosive) are detected near the unit. 
- Be aware that prolonged, direct exposure to cool air from the air conditioner, or to air that is too cool, can be harmful to your physical condition and health.
- Do not place objects, including rods, your fingers, etc., in the air inlet or outlet. Product damage may result due to contact with the air conditioner's high-speed fan blades.
- Do not attempt to repair, dismantle, reinstall or modify the air conditioner yourself as this may result in water leakage, electric shock or fire hazards.
- Do not use flammable spray (like hair spray, insecticides, disinfectants, air dusters or cleaners, deodorants etc.) near to the product. It can cause fire, water leak or malfunction etc.
- Do not use a refrigerant other than the one indicated on the outdoor unit (R32) when installing, moving or repairing. Using other refrigerants may cause trouble or damage to the unit, and personal injury.
- To avoid electric shock, do not operate with wet hands.

- Beware of fire in case of refrigerant leakage. If the air conditioner is not operating correctly, i.e. not generating cool air, refrigerant leakage could be the cause. Consult your service centre for assistance. The refrigerant within the air conditioner is safe and normally does not leak.  However, in the event of a leakage, contact with a naked burner, heater or cooker may result in generation of noxious gas. Do not use the air conditioner until a qualified service person confirms that the leakage has been repaired.
- Do not attempt to install or repair the air conditioner yourself. Improper workmanship may result in water leakage, electric shock or fire hazards. Please contact your local service centre or qualified personnel for installation and maintenance work.
- If the air conditioner is malfunctioning (giving off a burning odour, etc.), turn off power to the unit and contact your local service centre. Continued operation under such circumstances may result in a failure, electric shock or fire hazards.
- Be sure to install an earth leakage circuit breaker. Failure to install the earth leakage circuit breaker may result in electric shock or fire.

- Be sure to earth the unit. Do not earth the unit to a utility pipe, lightning conductor or telephone earth lead. Imperfect earthing may result in electric shock. 

## CAUTION

- Do not use the air conditioner for purposes other than those for which it is intended. Do not use the air conditioner for cooling precision instruments, food, plants, animals or works of art as this may adversely affect the performance, quality and/or longevity of the object concerned. 
- Do not expose plants or animals directly to the airflow from the unit as this may cause adverse effects.
- Do not place appliances that produce naked flames in places exposed to the airflow from the unit as this may impair combustion of the burner.
- Do not block the air inlets or outlets. Impaired airflow may result in insufficient performance or trouble.
- Do not sit on the outdoor unit, put things on the unit, or pull the unit. Doing so may cause accidents, such as falling or toppling down, thus resulting in injury, product malfunctioning, or product damage.
- Do not place objects that are susceptible to moisture directly beneath the indoor or outdoor units. Under certain conditions, condensation on the main unit or refrigerant pipes, air filter dirt or drain blockage may cause dripping, resulting in fouling or failure of the object concerned.
- After prolonged use, check the unit stand and its mounts for damage. If they are left in a damaged condition, the unit may fall and cause injury.
- To avoid injury, do not touch the air inlet or aluminium fins of the indoor or outdoor units.
- The appliance is not intended for use by unattended young children or infirm persons. Impairment of bodily functions and harm to health may result.
- Children should be supervised to ensure that they do not play with the unit or its remote controller. Accidental operation by a child may result in impairment of bodily functions and harm health.
- Avoid impacts to the indoor and outdoor units, or otherwise product damage may result.
- Do not place flammable items, such as spray cans, within 1m of the air outlet. The spray cans may explode as a result of hot air from the indoor or outdoor units.
- Be careful not to let pets urinate on the air conditioner. Urination on the air conditioner may result in electric shock or fire.
- Do not wash the air conditioner with water, as this may result in electric shock or fire.
- Do not place water containers (vases, etc.) above the unit, as this may result in electric shock or fire hazards if they should topple over.
- Do not insert the batteries in the wrong polarity (+/-) orientation as this may result in short circuiting, fire, or battery leakage.

- To avoid oxygen depletion, ensure that the room is adequately ventilated if equipment such as a burner is used together with the air conditioner. 
- Before cleaning, be sure to stop unit operation and turn off the circuit breaker. Otherwise, an electric shock and injury may result.
- Only connect the air conditioner to the specified power supply circuit. Power supplies other than the one specified may result in electric shock, overheating and fires.
- Arrange the drain hose to ensure smooth drainage. Imperfect drainage may cause wetting of the building, furniture, etc.
- Do not place objects in direct proximity of the outdoor unit and do not let leaves and other debris accumulate around the unit. Leaves are a hotbed for small animals which can enter the unit. Once inside the unit, such animals can cause malfunctions, smoke or fire if they come into contact with electrical parts.
- Do not place objects around the indoor unit. Doing so may have an adverse influence on the performance, product quality, and life of the air conditioner.
- This appliance is not intended to be used by persons with reduced physical, sensory or mental capabilities, or with lack of operation knowledge, unless they have been given supervision or instruction concerning the appliance use by person responsible for their safety. Keep out of children's reach to ensure that they do not play with the appliance.

# Name of Parts

## Indoor Unit

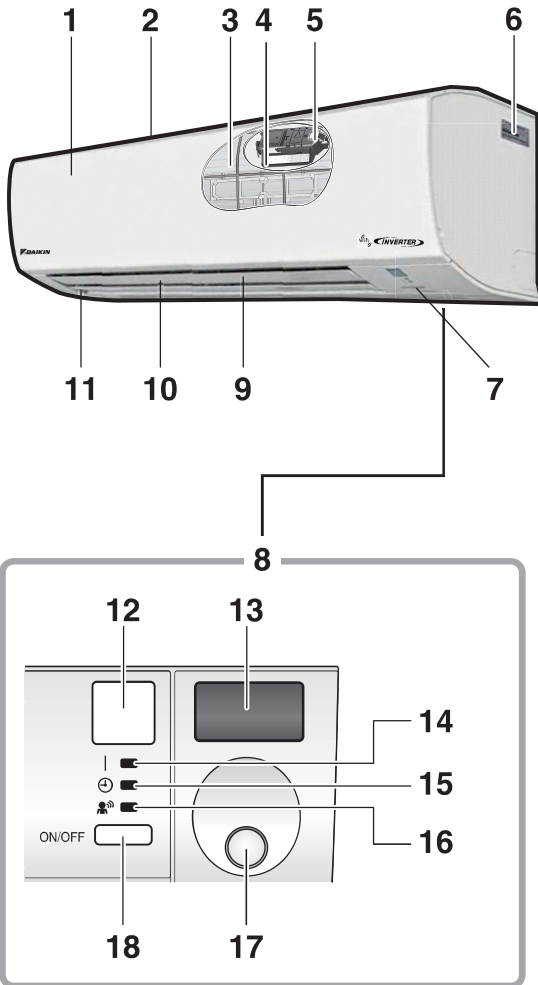

1. Front panel
2. Air inlet
3. Air filter
4. Accessory filter
5. Streamer unit
6. Model name plate
7. Indoor temperature sensor:
  - Detects the air temperature around the unit.
8. Display
9. Air outlet
10. Louvres (vertical blades):
  - The louvres are inside the air outlet. ▶Page 11
11. Flaps (horizontal blades) ▶Page 11

12. Signal receiver:
  - Receives signals from the remote controller.
  - When the unit receives a signal from remote controller then user will hear a beep sound.

| Case             | Sound type |
|------------------|------------|
| Operation start  | beep-beep  |
| Settings changed | beep       |
| Operation stop   | long beep  |

- When unit receives Command from App or smart speaker controller, then user will not hear beep sound.

13. Inverter output and temperature display ▶Page 10

14. OPERATION lamp (green)

15. TIMER lamp (orange) ▶Page 19-21

16. INTELLIGENT EYE lamp (green) ▶Page 25-26

17. INTELLIGENT EYE sensor ▶Page 24

18. Indoor unit ON/OFF switch:

- Press this switch once to start operation. Press once again to stop it.
- For the operation mode setting, refer to the following table.

| Mode | Temperature setting | Airflow rate |
|------|---------------------|--------------|
| COOL | 22°C                | AUTO         |

- This switch can be used when the remote controller is missing.

19. Air inlet (back and side)

20. Outdoor temperature sensor (back)

21. Refrigerant pipes and inter-unit wire

22. Drain hose

23. Earth terminal (inside)

24. Model name plate

25. Air outlet

## Outdoor Unit

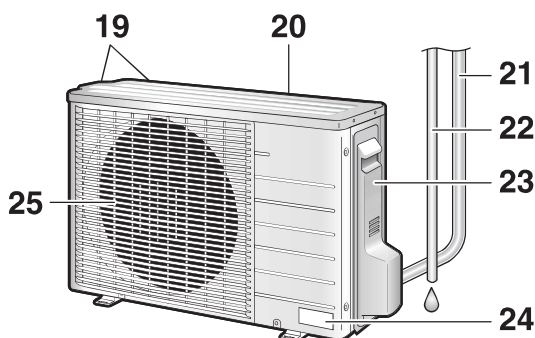

Appearance of the indoor/outdoor unit may differ between different models

# Name of Parts

## ■ Remote Controller

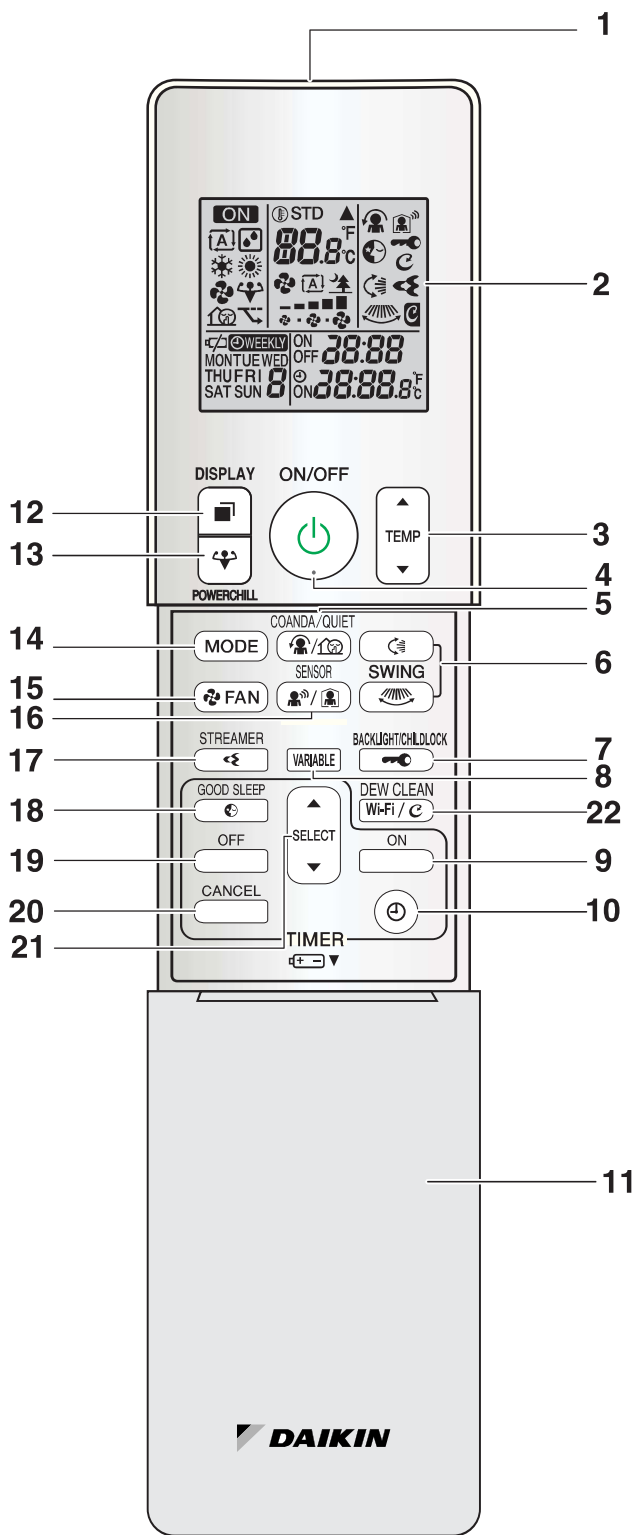

(Model : ARC479B27)

### 1. Signal transmitter:

- Send signals to the indoor unit.

### 2. Display (LCD):

- Displays the current setting.  
(In this illustration, each section is shown with its display on for the purpose of explanation.)

### 3. TEMPERATURE adjustment button:

- Changes the temperature setting. ▶Page 9

### 4. ON/OFF button:

- Press this button once to start operation.  
Press once again to stop it. ▶Page 8

### 5. COANDA/QUIET button ▶Page 14

### 6. SWING button:

- Adjusts the airflow direction. ▶Page 11

### 7. BACKLIGHT/CHILDLOCK button ▶Page 22

### 8. VARIABLE button ▶Page 16

### 9. ON TIMER button ▶Page 19

### 10. CLOCK button ▶Page 7

### 11. Front cover:

- Open the front cover.

### 12. DISPLAY button ▶Page 10

### 13. POWER CHILL button ▶Page 13

### 14. MODE selector button:

- Selects the operation mode.  
(DRY/COOL/FAN) ▶Page 8

### 15. FAN setting button:

- Selects the airflow rate setting. ▶Page 12

### 16. INTELLIGENT EYE button ▶Page 24

### 17. STREAMER button ▶Page 18

### 18. GOOD SLEEP OFF TIMER button ▶Page 21

### 19. OFF TIMER button (NIGHT SET mode) ▶Page 20

### 20. TIMER CANCEL button:

- Cancels the timer setting. ▶Page 19-21

### 21. SELECT button:

- Changes the clock, ON/OFF TIMER and GOOD SLEEP OFF TIMER settings.

### 22. WIFI/DEW CLEAN button ▶Page 27



# Preparation before Operation

## CAUTION

Incorrect handling of batteries can result in injury from battery leakage, rupturing or heating, or lead to equipment failure. Please observe the following precautions and use safely.

- If the solution from the batteries should get in the eyes, do not rub the eyes. Instead, immediately flush the eyes with tap water and seek the attention of a medical professional.
- Keep batteries out of reach of children. In the event that batteries are swallowed, seek the immediate attention of a medical professional.
- Do not expose batteries to heat or fire. Do not disassemble or modify batteries. The insulation or gas release vent inside the battery may be damaged, resulting in battery leakage, rupturing, or heating.
- Do not damage or peel off labels on the batteries.

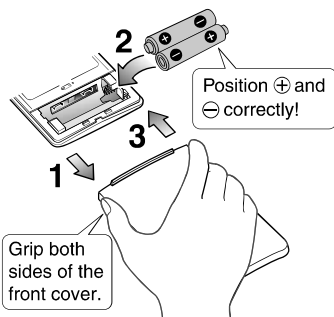

### ■ To insert the batteries

1. Slide the front cover to take it off.
2. Insert 2 dry batteries (AAA).
3. Set the front cover as before.

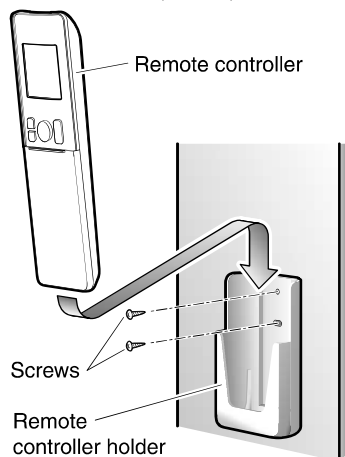

### ■ To attach the remote controller holder to a wall

1. Choose a place from where the signals reach the unit.
2. Attach the holder to a wall, a pillar, or similar location with the screws supplied with the holder.
3. Place the remote controller in the remote controller holder.

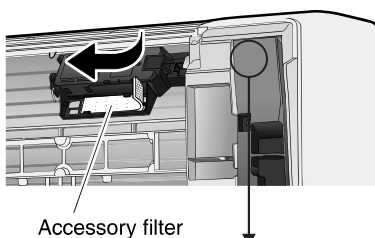

### ■ To attach the accessory filter

- Set the accessory filter under the tabs of the streamer unit. Filter type: Micro-filter (PM 1.0)
- When attaching the accessory filter, refer to “Care and Cleaning”, and pull out the air filters. [▶Page 31-34](#)
- User is recommended to note down SSID and Key details. This will be helpful during wireless LAN Connection.

### ■ Turn on the circuit breaker

- After the power is turned on, the flaps of the indoor unit open and close once to set the reference position.

## NOTE

SSID :DaikinAPXXXXX  
KEY :XXXXXXXXXXXXX  
Wi-Fi Module SSID Sticker

### ■ Notes on batteries

- Do not use a leaking battery.
- To avoid possible injury or damage from battery leakage or rupturing, remove the batteries when not using the product for long periods of time.
- The standard replacement time is about 1 year. Both batteries should be replaced at the same time. Be sure to replace them with new size AAA dry batteries.
- When battery power has run out, “ ” will begin blinking on the LCD as an alert that the batteries need replacing. In some cases, when battery consumption is accelerated owing usage conditions, signal reception may decline before the LCD begins blinking.

# Preparation before Operation

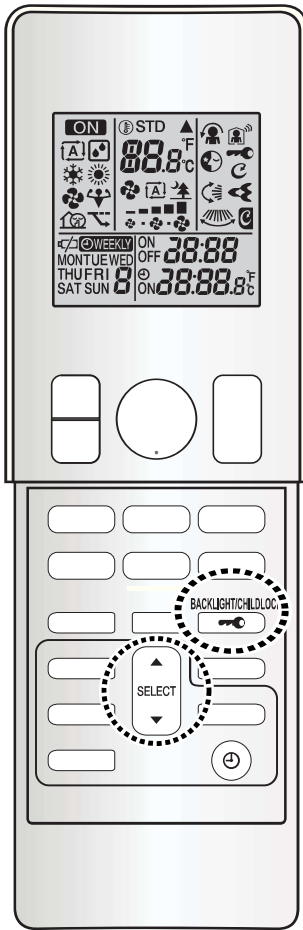

## ■ To set the clock

1. Press .

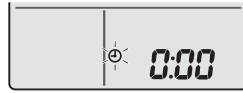

• “⏻” blinks.

2. Press  to set the clock to the present time.

• Holding down ▲ or ▼ rapidly increases or decreases the displayed time.

3. Press .



• “:” blinks.

## ■ To set the BACKLIGHT

Turning off the LCD backlight reduces battery consumption. (Default: on)

1. Press  button.

• Each pressing of button switches the backlight ON/OFF.  
When it is switched off, the backlight goes out.

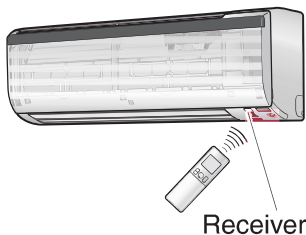

## ■ To operate the remote controller

- To use the remote controller, aim the transmitter at the indoor unit. If there is anything blocking the signals between the unit and the remote controller, such as a curtain, the unit will not operate.
- Do not drop the remote controller. Do not get it wet.
- The maximum transmission distance is about 7m.  
(When in front of unit at angle 0° without any interference)

## NOTE

### ■ Notes on remote controller

- Never expose the remote controller to direct sunlight.
- Dust on the signal transmitter or receiver will reduce the sensitivity. Wipe off dust with soft cloth.
- Signal communication may be disabled if an electronic-starter-type fluorescent lamp (such as inverter-type lamp) is in the room. Consult your service centre if that is the case.
- If the remote controller activates other electric devices, move them away or consult your service centre.



# DRY · COOL · FAN Operation

The air conditioner operates with the operation mode of your choice. From the next time on, the air conditioner will operate with the same operation mode.

## ■ To start operation

### 1. Press **MODE** and select an operation mode.

- Each pressing of the button changes the mode setting in sequence.

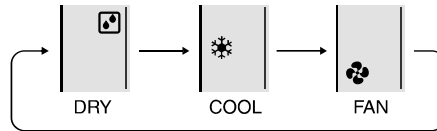

### 2. Press .

- “**ON**” is displayed on the LCD.
- The OPERATION lamp lights green.

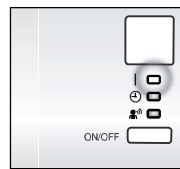

Display

## ■ To stop operation

### 1. Press again.

- “**ON**” disappears from the LCD.
- The OPERATION lamp goes off.
- All the indications disappear from the LCD. When the timer is set, the timer indication remains on the LCD.

## NOTE

### ■ Note on COOL operation

- This air conditioner cools the room by releasing heat in the room outdoors. Therefore, cooling performance may fall in higher outdoor temperatures.

### ■ Note on DRY operation

- Eliminates humidity while maintaining the indoor temperature as much as possible. It automatically controls temperature and airflow rate, so manual adjustment of these functions is unavailable.

### ■ Note on FAN operation

- This mode is valid for fan only.



# Adjusting the Temperature

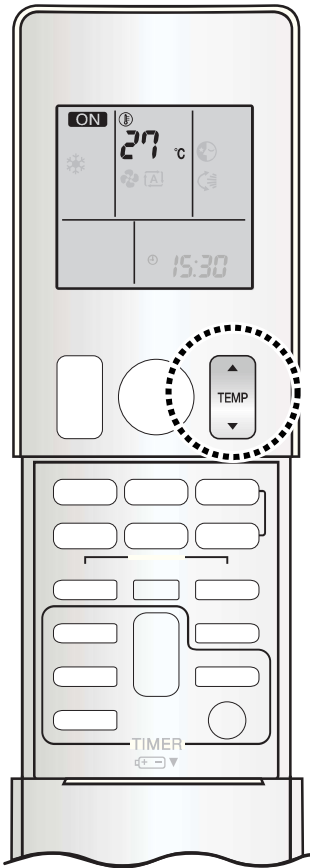

## ■ To change the temperature setting

1. Press .

- Press ▲ to raise the temperature and press ▼ to lower the temperature.

| COOL operation | DRY or FAN operation                       |
|----------------|--|
| 18-32°C        | The temperature setting cannot be changed. |

### ❖ Default Set Temperature Setting :

- As per BEE regulation, whenever Air Conditioner will be switched ON from the remote, the default set temperature will be set as mentioned in below table :

| Mode | Set temperature before remote switched OFF | Set temperature after remote switched ON                                      |
|------|--|---|
| Cool | If Set temperature < 24° C                 | Default set temperature will be 24° C.  |
|      | If Set temperature >= 24° C                | Default set temperature will remain same as set prior to remote switched OFF. |

### Note:

Whenever AC is switched OFF in dry mode and is switched ON from remote, air conditioner will start in Cool mode and then DRY mode selection can be done using the MODE button.

## NOTE

### ■ Recommended temperature setting

- For cooling: 26-28°C

### ■ Notes on the operating conditions

- The air conditioner always consumes a small amount of electricity even while it is not operating.
- If you are not going to use the air conditioner for a long period, turn off the circuit breaker.
- Operation outside the humidity or temperature range described in the table may cause a safety device to disable the system.

| Mode | Operating conditions  | If operation is continued out of this range   |
|------|---|---|
| COOL | Outdoor temperature: 10-54°C<br>Indoor temperature: 18-32°C | <ul style="list-style-type: none"> <li>• A safety device may activate to stop the operation.</li> <li>• Dew may form on the indoor unit and drip from it when COOL or DRY operation is selected.</li> </ul> |
| DRY  | Indoor humidity: 80% max.                                   |   |

### ■ Tips for saving energy

- Be careful not to cool the room too much. Keeping the temperature setting at a moderate level helps save energy.
- Cover windows with a blind or a curtain. Blocking sunlight and air from outdoors increases the cooling effect.
- Clogged air filters cause inefficient operation and waste energy. Clean them once in about every 2 weeks.





# Checking the Inverter Output and Temperature Display

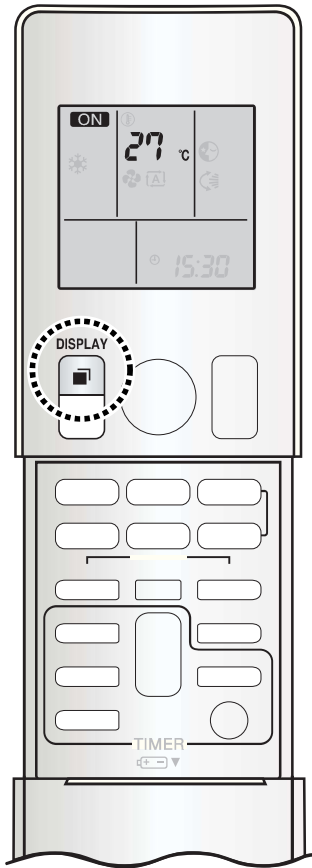

Inverter output and temperature display

The inverter output and temperature display for the indoor unit shows the current inverter output, indoor temperature, and set temperature.

## ■ Checking current inverter output, indoor temperature and set temperature when the air conditioner is in operation

1. Press  during operation.

- Each press of  cycles the display through current inverter output, indoor temperature, and set temperature.

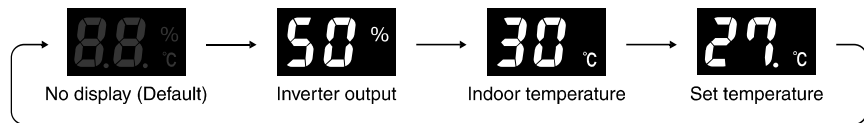

- Inverter output serves as an estimate of power consumption. (where rated power consumption is 100%)
- There is a “.” (dot) after the set temperature figure.
- Inverter output does not display when the unit is in FAN operation.
- Set temperature does not display when the unit is in DRY operation or FAN operation.
- Inverter output and set temperature may not display depending on the operation mode that is active.
- The display turns off when the unit is turned off.

## ■ Checking current indoor temperature when the air conditioner is off

1. Press  when the air conditioner is off.

- The current indoor temperature displays.
- Press the button again to turn off the display.

## NOTE

### ■ Note on the inverter output and temperature display

- “F.L.” displays as inverter output when the rated power consumption is exceeded.
  - “- -” may display for a short while after the air conditioner is turned on or at other times.
  - Inverter output may be low at times for the purposes of protecting the product.
  - When the unit is operated using another device, such as a wired remote controller or smartphone, the set temperature displayed may not match the set temperature on the remote controller.
- An error code will display if the air conditioner fails to operate when turned on. Consult your service centre. Refer to the error code table in “**Troubleshooting**”.  Page 35-38
- Display is default OFF.





# Adjusting the Airflow Direction

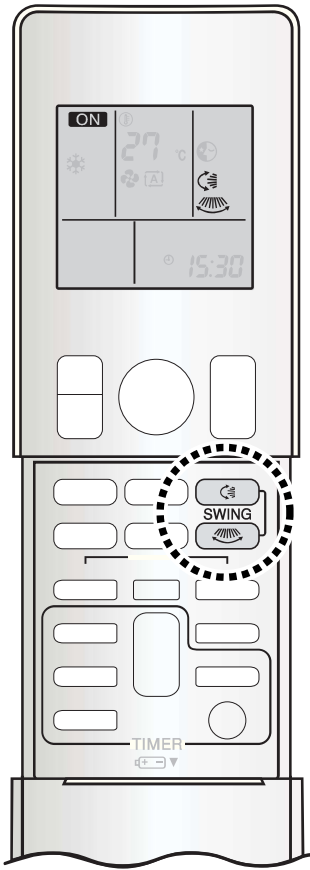

You can adjust the airflow direction to increase your comfort.

## CAUTION

- Always use a Remote Controller or Smartphone Application to adjust the angles of the flaps and louvres.
  - If you attempt to move the flaps and louvres forcibly by hand when they are swinging, the mechanism may be damaged.
  - Inside the air outlet, a fan is rotating at a high speed.

### ■ To start auto swing

#### Up and down airflow direction

1. Press .

- “” is displayed on the LCD.
- The flaps (horizontal blades) will begin to swing.

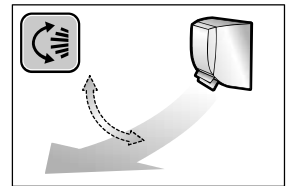

#### Right and left airflow direction



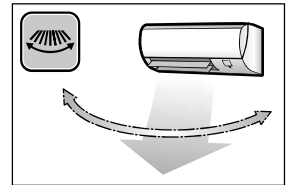

1. Press .

- “” is displayed on the LCD.
- The louvres (vertical blades) will begin to swing.



#### The 3-D airflow direction

1. Press  and .

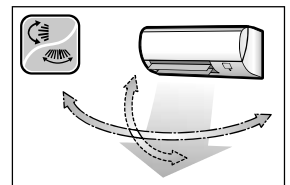

- “” and “” are displayed on the LCD.
- The flaps and louvres move in turn.
- To cancel 3-D airflow, press either  or  again. The flaps or louvres will stop moving.



### ■ To set the flaps or louvres at desired position

- This function is effective while the flaps or louvres are in auto swing mode.

1. Press  and  when the flaps or louvres reach the desired position.

- In the 3-D airflow, the flaps and louvres move in turn.
- “” or “” disappears from the LCD.

## NOTE

### ■ Note on 3-D airflow

- Using 3-D airflow circulates cold air, which tends to collect at the bottom of the room, throughout the room, preventing areas of cold developing.



# Adjusting the Airflow Rate / SMELL PROOF Operation

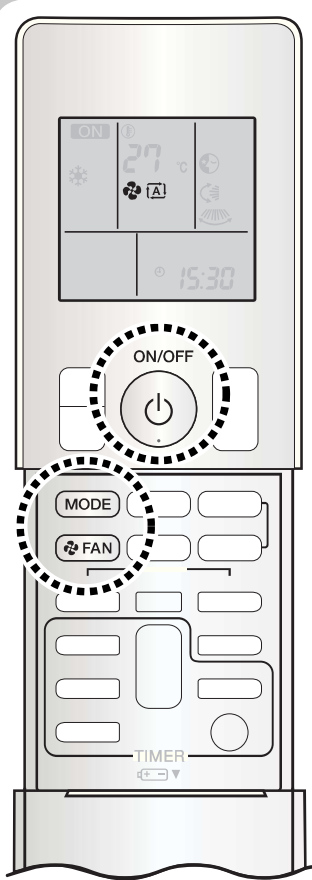

## ■ Adjusting the airflow rate

You can adjust the airflow rate to increase your comfort.

### ■ To change the airflow rate setting

#### 1. Press .

- Each pressing of  changes the airflow rate setting in sequence.

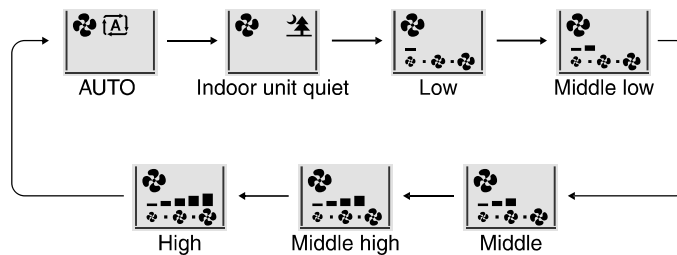



- When the airflow is set to “”, quiet operation starts and noise from the indoor unit will become quieter.
- In the quiet operation mode, the airflow rate is set to a weak level.
- In DRY operation, the airflow rate setting cannot be changed.

## ■ SMELL PROOF operation

The SMELL PROOF operation prevents unpleasant odour inside the indoor unit. This function is available in both DRY and COOL operation.

### ■ To use SMELL PROOF operation

1. Before starting the operation, press  to set to AUTO.
2. Press  to select the DRY or COOL operation.

#### 3. Press .

- Air starts circulating about 1 minute after the operation is started.

### ■ To cancel SMELL PROOF operation

1. Change the airflow rate setting to a setting other than AUTO.

## NOTE

### ■ Note on airflow rate setting

- At smaller airflow rates, the cooling effect is also smaller.

### ■ Note on SMELL PROOF operation

- SMELL PROOF operation can prevent some odours, but not all.



# POWER CHILL Operation

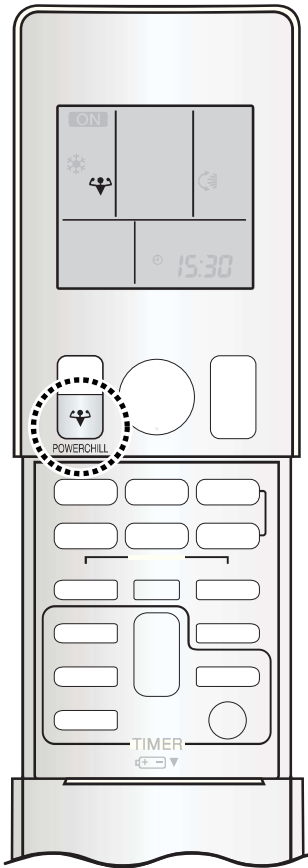

POWER CHILL operation quickly maximises the cooling effect in any operation mode. In this mode, the air conditioner operates at maximum capacity.

## ■ To start POWER CHILL operation

1. Press  during operation.

- “” is displayed on the LCD.
- POWER CHILL operation ends in 20 minutes. Then the system automatically operates again with the previous settings which were used before POWER CHILL operation.

## ■ To cancel POWER CHILL operation

1. Press  again.

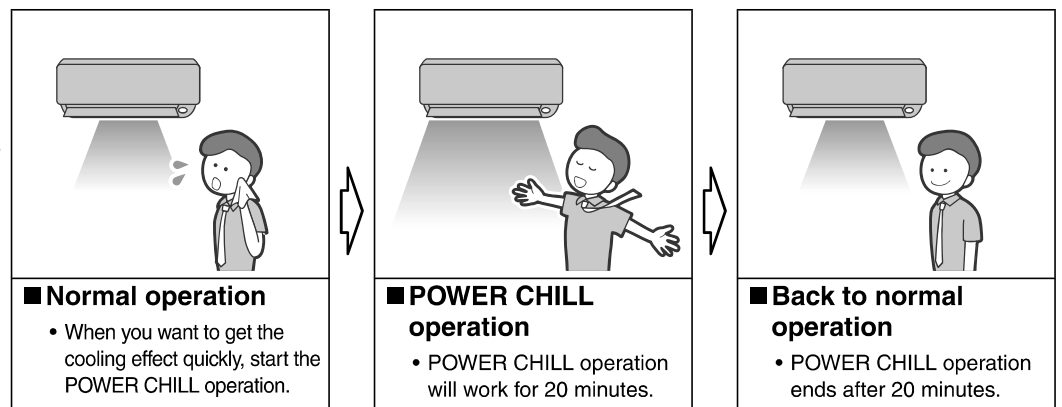

- “” disappears from the LCD.

### [Example]



## NOTE

### ■ Notes on POWER CHILL operation

- When POWER CHILL operation is started, the flaps turn downward, allowing the air to blow directly onto people. When the up and down airflow direction is set to auto swing, the flaps move in auto swing mode.
- When using POWER CHILL operation, there are some functions which are not available.
- POWER CHILL operation cannot be used together with VARIABLE and OUTDOOR UNIT QUIET operation. Priority is given to the function of whichever button is pressed last.
- POWER CHILL operation can only be set when the unit is running. Pressing  causes the settings to be cancelled, and “” disappears from the LCD.
- POWER CHILL operation will not increase the capacity of the air conditioner if the air conditioner is already in operation with its maximum capacity demonstrated.
- **In COOL operation**  
To maximise the cooling effect, the capacity of outdoor unit is increased and the airflow rate becomes fixed at the maximum setting.  
The temperature and airflow settings cannot be changed.
- **In DRY operation**  
The temperature setting is lowered by 2.5°C and the airflow rate is slightly increased.
- **In FAN operation**  
The airflow rate is fixed at the maximum setting.





# COANDA/OUTDOOR UNIT QUIET Operation

## ■ COANDA operation

Directs airflow upward. This function prevents air from blowing directly at users.

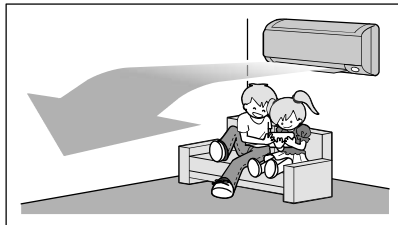

## ■ OUTDOOR UNIT QUIET operation

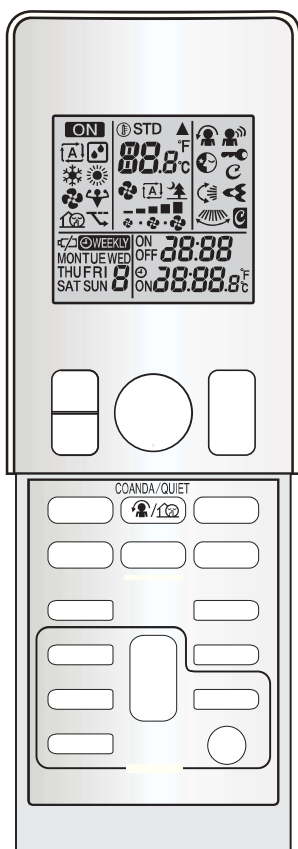

OUTDOOR UNIT QUIET operation lowers the noise level of the outdoor unit by changing the frequency and fan speed of the outdoor unit. This function is convenient during the night-time operation.

### ■ To start operation

1. Press  and select the desired mode.

- Each time  is pressed, a different setting option is displayed on the LCD.



### ■ To cancel operation.

1. Press  until no icon is displayed.

## ■ Combination COANDA and OUTDOOR UNIT QUIET operation

The air conditioner can go into operation with the COANDA and OUTDOOR UNIT QUIET operations combined.



# COANDA/OUTDOOR UNIT QUIET Operation

## ■ To combine COANDA and POWER CHILL operation

When POWER CHILL operation is started during COANDA operation, the flaps turn downward, allowing the air to blow directly onto people. The combination of COANDA and POWER CHILL operations provides sufficient cooling performance to quickly cool down the room.

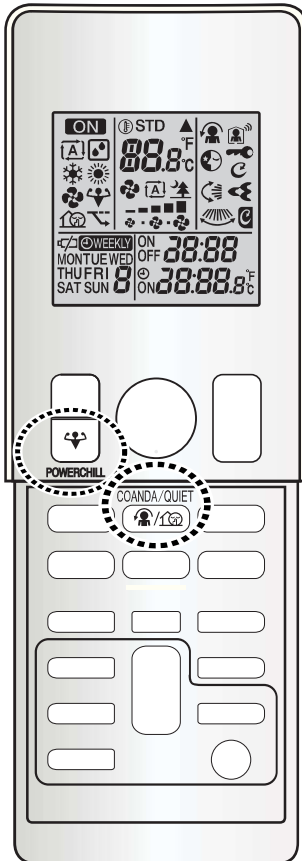

### 1. Press and select the desired mode.

- After POWER CHILL operation is finished, the air conditioner automatically returns to COANDA operation.
- Pressing  during POWER CHILL operation prevents the air from blowing directly onto people while keeping POWER CHILL operation running.

## NOTE

### ■ Notes on COANDA operation

- If the up and down airflow direction is selected, the COANDA operation will be cancelled. Priority is given to the function of whichever button is pressed last.

### ■ Notes on OUTDOOR UNIT QUIET operation

- This function is available in COOL operation. This is not available in FAN and DRY operation.
- POWER CHILL operation and OUTDOOR UNIT QUIET operation cannot be used at the same time. Priority is given to the function of whichever button is pressed last.
- Even if the operation is stopped by using the remote controller or the indoor unit ON/OFF switch when using OUTDOOR UNIT QUIET operation, "🏠" will remain displayed on the remote controller.
- OUTDOOR UNIT QUIET operation will not reduce the frequency nor fan speed if they already are operating at reduced levels.
- This operation is performed with lower power and therefore may not provide a sufficient cooling effect.

# VARIABLE Operation

## ■ VARIABLE Operation

- Variable operation provides users with manual control to select the air conditioner's capacity based on the number of persons, room size, and outside conditions.
- Users can adjust the air conditioner capacity to 100% (L1), 85% (L2), 70% (L3), 55% (L4), and 40% (L5) of the rated capacity.

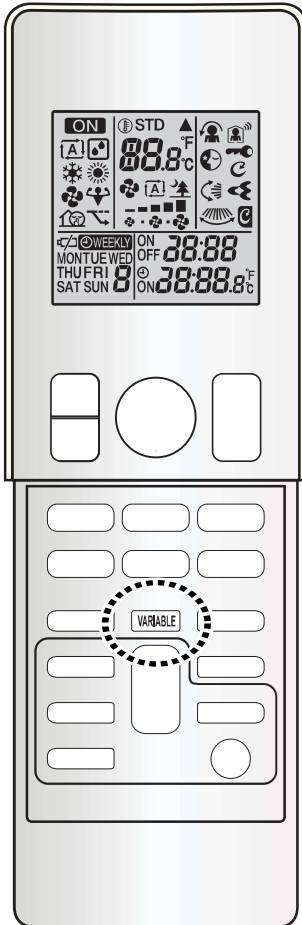

### ■ To start the Variable operation :

- Using the remote, turn on the air conditioner.
- Press the “Variable” button on the remote controller.
- If the user turns on variable operation for the first time, the “” symbol along with the L1 step will be displayed on the remote LCD.
- By pressing the “Variable” button on the remote controller, the user can select different capacities ranging from L2/L3/L4/L5.
- After receiving a command from the remote controller, the IDU 7-segment display will also show the corresponding capacity step.

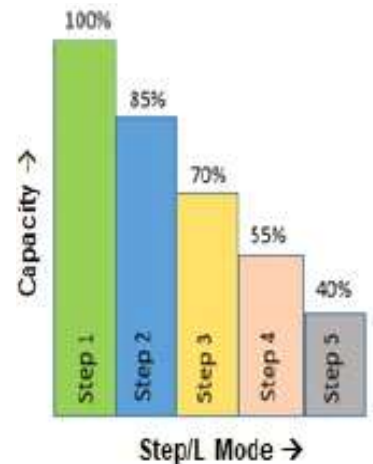

### ■ To check the Variable operation capacity step :

- If the user wants to check which capacity step is currently in operation, they need to press the “Variable” button on the remote controller.
- The last capacity step will be displayed on the remote LCD.
- Users can also check capacity step details on the IDU 7-segment display.

#### • IDU : 7 Segment Display

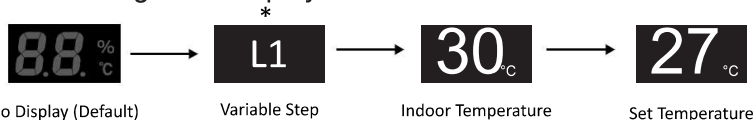

\* L1 / L2 / L3 / L4 / L5

## ■ To cancel the Variable operation :

- If Variable operation is already turned ON, and the user wants to turn OFF the variable operation, then the user needs to press the “**Variable**” button on the remote controller.
- The remote LCD will display the last selected capacity step; for example, "L2" will be shown on the remote LCD.
- User needs to press the “**Variable**” button in the following manner until normal operation.

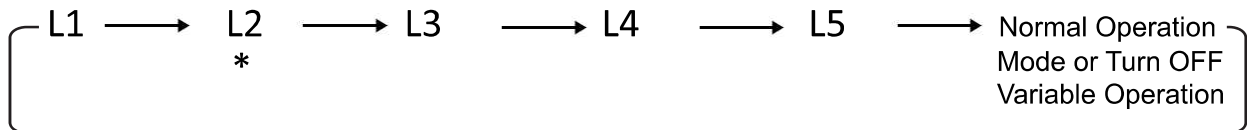

### \* Last Memorised Step

“” symbol will be removed from the remote LCD.

## ■ Notes on the Variable Operation :

1. In the event of a power failure, the selected capacity step will be memorized and retained when power is restored.
  2. This function operates only in Dry, Cool, Heat, and Auto modes.
  3. Power Chill, Power Full, Dew Clean, and Fan Mode operations cannot be used together with the Variable function. Priority will be given to the last selected function.
  4. If the user removes the battery and reinserts it while using the Variable function, the variable feature is turned off on the remote. The user will need to restart the Variable operation and select the desired capacity step again.
  5. For the safety and reliability of the AC, the Variable function may not work in lower and higher outdoor ambient conditions.
  6. It is recommended that the user does not turn off the operation lamp and timer lamp LEDs (using the Brightness control function). Otherwise, the user will not be notified in case they select the wrong step in accordance with the heat load condition.
  7. If the user selects a capacity step that is not in accordance with the room heat load conditions, this function will notify the user to change the capacity step, as defined below:
    - After 30 minutes of the machine working, the Operation Lamp (Green) and Timer Lamp (Orange) will blink for 30 seconds to indicate to the user that they should change the capacity step.
    - If the user does not change the capacity step, the next judgment will be taken after the next 15 minutes of machine working. Until the user changes the capacity step, the Operation Lamp (Green) and Timer Lamp (Orange) will blink for 30 seconds to remind the user to change the capacity step.
    - In the event of a power failure during the above judgment, the timing will restart from zero once power is restored.
-  Green & orange LED blinking for about 30 seconds.





# FLASH STREAMER AIR PURIFYING Operation

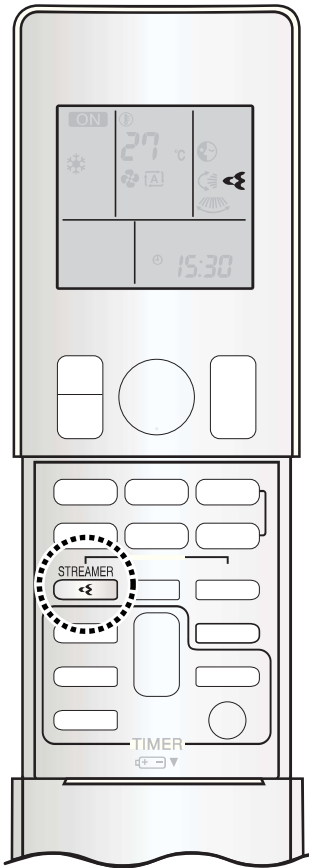

The absorption power of the accessory filter and the decomposition power of the streamer discharge combine to reduce unpleasant odours and viruses, cleaning the air in the room.

## ■ To start operation

1. Press <sup>STREAMER</sup>  .

- “” is displayed on the LCD.
- The air in the room is being cleaned.

## ■ To stop operation

1. Press <sup>STREAMER</sup>  .

- “” disappears from the LCD.
- The streamer will stop operating.

## NOTE

### ■ What is streamer discharge?

- This is a type of plasma discharge comprising high-speed electrons with a high oxidative capacity that is released within the unit. It decomposes odours and harmful gases.  
(The high-speed electrons are generated and then adsorbed within the unit to ensure your safety.)
- The streamer discharge may generate a hissing sound, however, this does not indicate a defect.

### ■ Note on FLASH STREAMER AIR PURIFYING operation

- When airflow is weak during operation, the streamer discharge may stop temporarily to prevent the emission of trace amounts of ozone from the air outlet.



# ON/OFF TIMER Operation

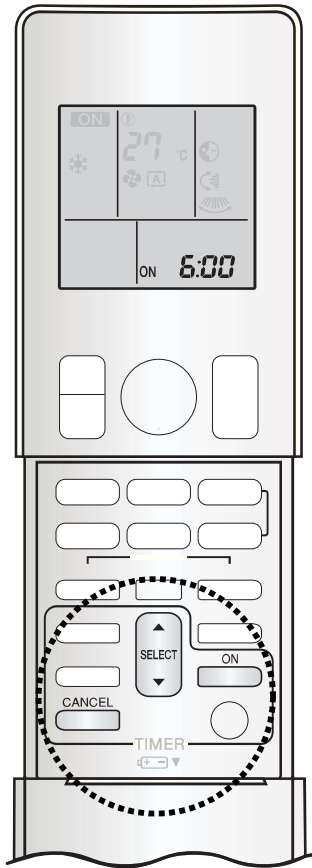

Timer functions are useful for automatically switching the air conditioner on or off in the morning or at night. You can also use the ON TIMER and OFF TIMER together.

## ■ To use ON TIMER operation

- Check that the clock is correct.  
If not, set the clock to the present time. ▶ Page 7

1. Press .



- “6:00” is displayed on the LCD.
- “ON” blinks.

- “⊕” disappears from the LCD.

2. Press  until the time setting reaches the point you like.

- Each pressing of either button increases or decreases the time setting by 10 minutes. Holding down either button changes the setting rapidly.

3. Press  again.

- “ON” and setting time are displayed on the LCD.
- The TIMER lamp lights orange. ▶ Page 4

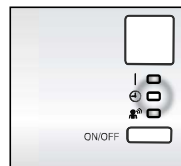

Display

## ■ To cancel ON TIMER operation

1. Press .

- “ON” and setting time disappear from the LCD.
- “⊕” is displayed on the LCD.
- The TIMER lamp goes off.

## NOTE

### ■ Notes on TIMER operation

- When TIMER is set, the present time is not displayed.
- Once you set ON/OFF TIMER, the time setting is kept in the memory.  
The memory is cleared when the remote controller batteries are replaced.
- When using the ON/OFF TIMER to start/stop operation, the actual operation start/stop time may differ from the time set. (Maximum of about 10 minutes)

### ■ In the following cases, set the timer again.

- After the circuit breaker has turned off.
- After a power failure.
- After replacing the batteries in the remote controller.



# ON/OFF TIMER Operation

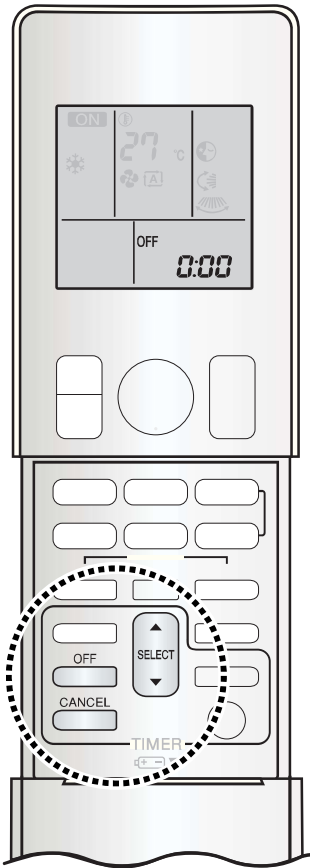

## ■ To use OFF TIMER operation

- Check that the clock is correct.  
If not, set the clock to the present time. ▶Page 7

1. Press .



- “0:00” is displayed on the LCD.
- “OFF” blinks.

- “⊕” disappears from the LCD.

2. Press  until the time setting reaches the point you like.

- Each pressing of either button increases or decreases the time setting by 10 minutes. Holding down either button changes the time setting rapidly.

3. Press  again.

- “OFF” and setting time are displayed on the LCD.
- The TIMER lamp lights orange. ▶Page 4

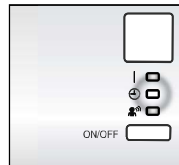

Display

## ■ To cancel OFF TIMER operation

1. Press .

- “OFF” and setting time disappear from the LCD.
- “⊕” is displayed on the LCD.
- The TIMER lamp goes off.

## ■ To combine ON TIMER and OFF TIMER

- A sample setting for combining the 2 timers is shown below.

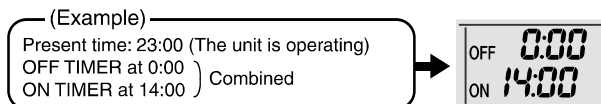



# GOOD SLEEP OFF TIMER Operation

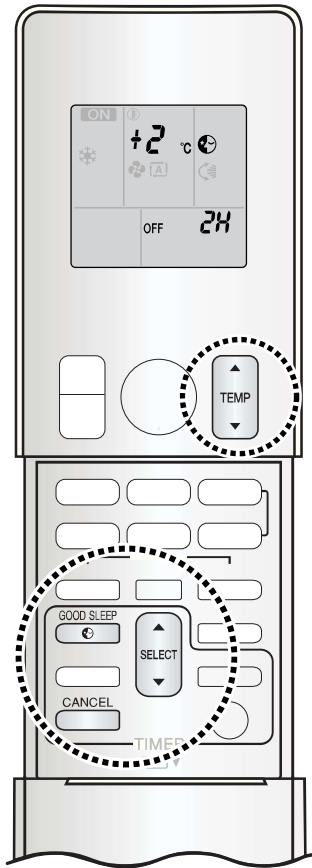

You can prevent excessive cooling of the room during sleep by setting a temperature shift value. The air conditioner automatically stops after the preset time has elapsed, thereby conserving electricity.

## ■ To use GOOD SLEEP OFF TIMER operation

1. Press  during COOL operation.

- “ °C ” blinks for a few seconds.
- The temperature shift value (default: +2) is displayed on the LCD for a few seconds.
- “ ☾ ”, “ OFF ”, and the stop time (default: 2H) , are displayed on the LCD.
- The TIMER lamp lights orange. ▶Page 4

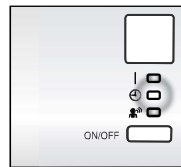

Display

2. Press  while “ °C ” is blinking.

- Each pressing of the button changes the temperature shift value by 1°C. You can specify a temperature shift value between +1°C and +5°C.

3. Press  or “  ” while “ °C ” is blinking.

- Each pressing of the button changes the time setting. The time can be set between 1 and 9 hours.  
1 hour ... → 9 hours → OFF

## ■ To cancel GOOD SLEEP OFF TIMER operation

1. Press .

- “ ☾ ”, “ OFF ”, and the stop time indication disappear from the LCD.
- The TIMER lamp goes off.

## NOTE

### ■ Notes on GOOD SLEEP OFF TIMER operation [Example]

- The set temperature increases by 0.5°C in 30 minutes until the total increase reaches the specified shift value. There is no function for heating the room.
- The temperature shift setting for GOOD SLEEP OFF TIMER operation is disabled while INTELLIGENT EYE operation is set. Cancel INTELLIGENT EYE operation.
- Good Sleep Off Timer would be disabled during Dew Clean operation.

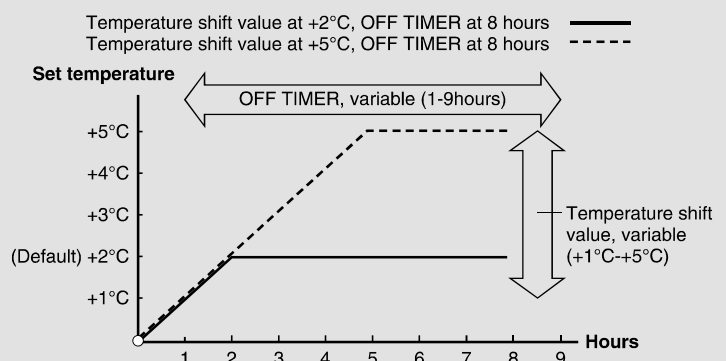



# BACKLIGHT/CHILD LOCK Operation

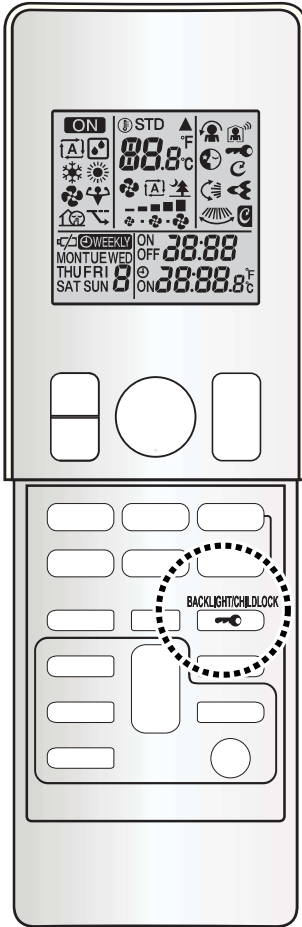

## ■ BACKLIGHT operation

### ■ To set the BACKLIGHT

Turning off the LCD backlight reduce battery consumption, (Default:on)

1. Press  button.

- Each pressing of button switches the backlight ON/OFF. When it is switched off, the backlight goes out. When it is switched on, the backlight comes on.



## ■ CHILD LOCK Operation

Setting the CHILD LOCK disables all the buttons except the CHILD LOCK button.

This function prevents children from operating the remote controller by mistake.

### ■ To set the CHILD LOCK

1. Press  for about 5 seconds.

- “” is displayed on the LCD.
- If a button is pressed while CHILD LOCK is on, “” blinks.

### ■ To cancel the CHILD LOCK

1. Press  for about 5 seconds.

- “” disappears from the LCD.



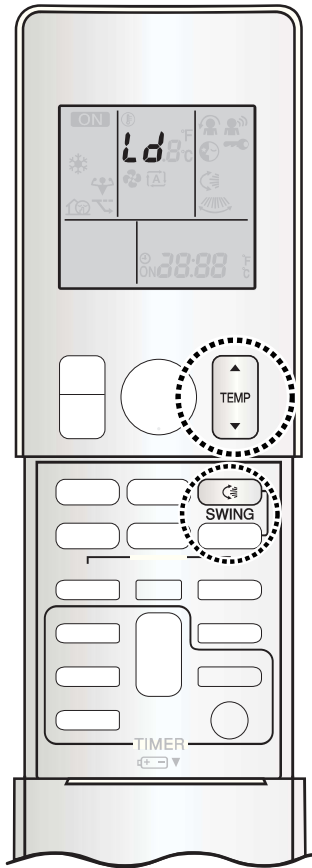

# LED / 7 SEGMENT BRIGHTNESS Control Operation



The brightness of the indicator lamp / 7 Segment can be adjusted H(high), L(low), or OFF.

**To set the brightness setting mode.**

- Press  for more than 5 seconds.
  - **Ld** is displayed on the LCD.
- Press  will show the last memory setting of brightness intensity of indicator lamp / 7 Segment.
- Again Press  to adjust the brightness to the indicator lamp / 7 Segment.

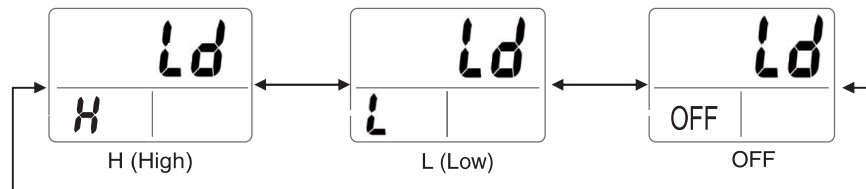

- Press  for more than 5 seconds again to exit from the brightness setting mode or when the remote controller is left untouched for 60 seconds, it returns to the normal mode automatically.

## NOTE

- “Ld” indicates for the brightness (Light) feature which is appeared on set temperature area.
- Remote will be in High Brightness Intensity by default whenever batteries inserted.
- Keep this in mind that If user sets LED lights to be in “OFF” state (using Brightness control feature) and if Power failure occurs then when power will resume LED will remain in OFF state (needs to reset LED Brightness Control again)



# Intelligent Eye Operation

## ENERGY SAVER Operation

The INTELLIGENT EYE sensor detects human movement.

If no one is in the room for more than 20 minutes, the operation automatically changes to energy saving operation.

### [ Example ]

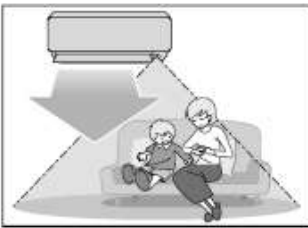

#### When someone is in the room

##### Normal Operation

- The air conditioner is in normal operation while the sensor is detecting human movement.

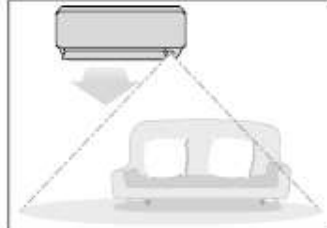

#### When no one is in the room

##### 20 minutes after, start energy saving operation.

- The set temperature is shifted in +2°C steps.

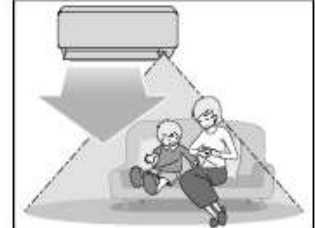

#### Someone is back in the room

##### Back to normal operation.

- The air conditioner will return to normal when the sensor detects human movement again.

## AUTO ON/OFF Operation

If no one in the range of Intelligent eye sensor for more than 1hr, then machine will go in standby mode. Once sensor detects the human presence then machine will automatically turn ON.

### [ Example ]

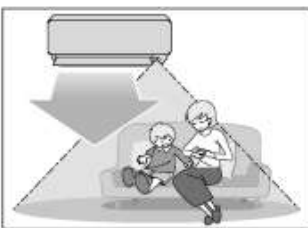

#### When someone is in the room

##### Normal Operation

- The air conditioner is in normal operation while the sensor is detecting human movement.

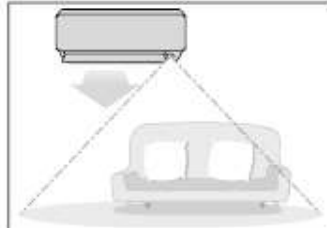

#### When no one is in the room

##### After 1hr, AC system will automatically turn off.

- The air conditioner will go in standby mode if no human movement is detected.

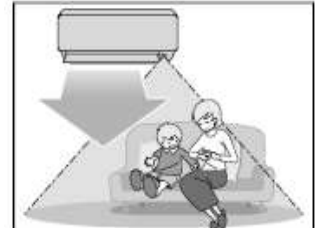

#### Someone is back in the room

##### Back to normal operation.

- The air conditioner will return to normal when the sensor detects human movement again.

## Combination Energy Saver and Auto ON/OFF Operation

User can activate both energy saver and Auto ON/OFF operations at same time.





# Intelligent Eye Operation

## INTELLIGENT EYE operation is useful for energy saving

### ■ Energy saver operation

- If no presence detected in the room for 20 minutes, the energy saving operation will start, and the INTELLIGENT EYE lamp goes off.  
If human movement is detected again, the INTELLIGENT EYE lamp light up and energy saving operation terminates.
- The operation changes the temperature by +2°C in COOL / +2°C in DRY operation from the set temperature.  
When the room temperature exceeds 30°C, the operation changes the temperature by +1°C in COOL / +1°C in DRY operation from the set temperature.
- This operation decreases the airflow rate slightly in FAN operation only.

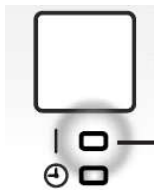

### ■ Auto On/Off operation

- If no presence detected in the room for 1hr, the unit will be turned off automatically by Auto On/Off function.
- The air conditioner will return to normal when the sensor detects human movement again.



Operation LED (green) will blink for 3min before operation stop.



### ■ To Start the Energy Saver Operation

- Press  button on the remote controller
-  displayed on the remote LCD.
- The Intelligent Eye lamp on the Indoor unit will turn ON.





Display



### ■ To Cancel the Energy Saver Operation

- Press  button on the remote controller.
-  disappears from the remote LCD.
- The Intelligent Eye lamp on the Indoor Unit will turn OFF.

### ■ To Start Auto ON/OFF Operation

- Press and hold  button for about 5 sec on the remote controller.
-  is displayed on the remote LCD.

### ■ To Cancel the Auto ON/OFF Operation



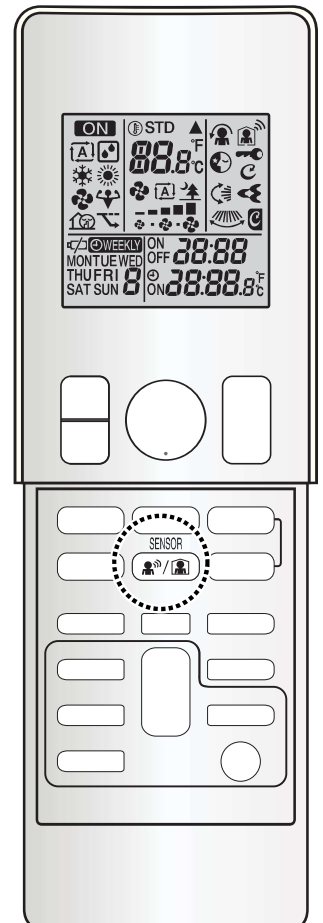

- Press and hold  button for about 5sec on the remote controller.
-  would disappear from the remote LCD.









# Intelligent Eye Operation

## □ To Start both Energy Saver and Auto ON/OFF Operation :

- Press  button on the remote controller.
-  is displayed on the remote LCD.
- The Intelligent Eye lamp on the Indoor unit will turn ON.
- Press and hold  button for about 5 sec on the remote controller
-  is displayed on the remote LCD.

## □ To Cancel both Energy Saver and Auto ON/OFF Operation :

- Press  button on the remote controller.
  - The Intelligent Eye lamp on the Indoor unit will turn OFF.
  -  is displayed on the remote LCD.
  - Press and hold  button for about 5 sec on the remote controller
  -  would disappear from the remote LCD.
- Both Energy Saver and Auto ON/OFF operations are deactivated.

## ⚠ CAUTION

- Do not place large objects near the INTELLIGENT EYE sensor. Also keep heating units or humidifiers outside the sensor's detection area. This sensor can detect undesirable object.
- Do not hit or violently push the INTELLIGENT EYE sensor. This can lead to damage and malfunction.

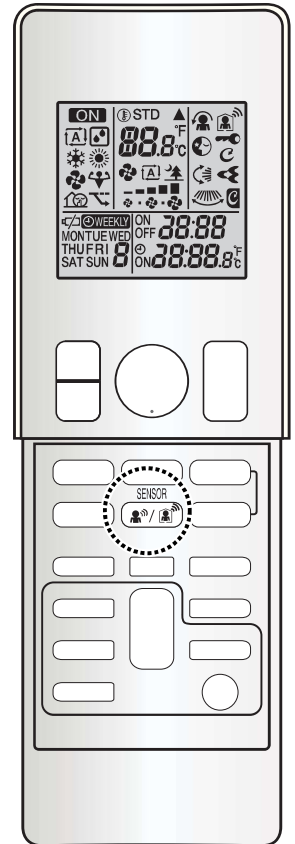

## NOTE

### ■ Notes on INTELLIGENT EYE operation

- Application range is as follows.

Horizontal angle 97.7°  
(Top view)

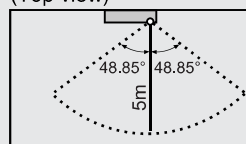

- The air conditioner may switch to energy-saving operation or may turn off by Auto ON/OFF if there are people in the area. This may occur depending on the clothes the people are wearing if there is no movement of the people in the area.
- The sensor may not detect moving objects further than 5m away. (Please see the application range)
- Sensor detection sensitivity changes according to the indoor unit location, the speed of passers-by, temperature range, etc.
- The sensor could also mistakenly detect pets, sunlight, fluttering curtains and light reflected off of mirrors as passers-by.
- When the right and left airflow direction is set to auto swing during INTELLIGENT EYE operation, the louvers move in auto swing mode. Even under these conditions, energy saving operation and Auto ON/OFF operation is in effect.
- When Good Sleep operation is used with INTELLIGENT EYE operations, set temperature due to Good Sleep will not increase.
- When Off timer is used with Auto On/Off operation, if machine gets off due to Off timer then machine will not start automatically.
- When machine is Off due to Auto ON/Off and ON timer is also under operation, then machine will ON by ON timer.
- If Auto On/Off is working and Machine gets turned Off and then turned ON through remote or mobile App with same previous remote or mobile App setting, then Auto On/Off timer would not reset till it detects any passers-by.
- Whenever machine goes to stand-by mode due to Auto ON/Off operation, then 7 segment display will remain Off even after machine gets turned ON due to detection by Intelligent Eye.
- In case of main power failure in between Energy saver and Auto ON/Off operation, machine timer will resume to zero.
- If remote batteries are removed/replaced and reinserted during energy saver and Auto ON/Off operation then these features would be removed only from remote controller and user need to again turn ON the INTELLIGENT EYE operations through remote as per provided procedures.
- Use of Intelligent eye is not recommended during night time (while sleeping).
- If user press both features at same time then unit will set only last feature, for example, if user press Energy Saver and then Auto On/Off at same time, then only Auto ON/Off would be active

## Wi-Fi Operation

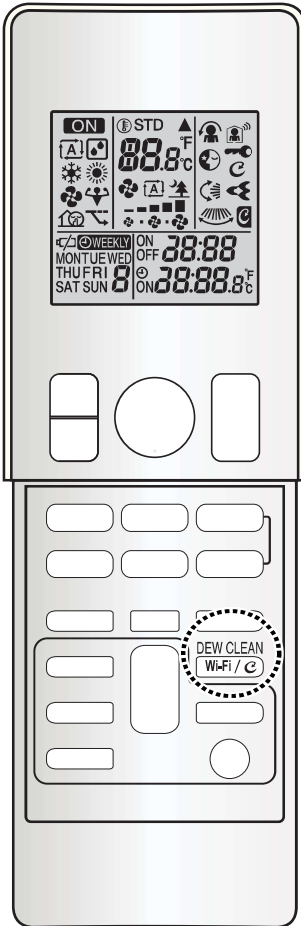

### To connect the wireless LAN connecting adapter to your home network

- To connect the wireless LAN adaptor with the home network, firstly turn ON the machine through main power supply.
- Turn Off the machine through remote, keep remote display ON while machine is turned OFF.
- With remote display ON, Press Wi-Fi key for about 5 seconds and follow below process.

The wireless LAN connecting adapter can be connected to your home network by means of:

- 1) Simple connection (WPS connection), if there is a WPS button on the router.
- 2) Access point connection (AP connection), if there is no WPS button on the router.

#### ■ Simple connection (WPS connection)

- 1) Press and hold  button on remote controller for about 5sec.

- 2) Press  or  button and select number 2.

- “SP” appears on the LCD.
- “2” Blinks.

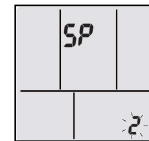



- 3) Press  button to confirm the WPS selected setting.

- “▲” blinks.
- Operation & Timer LED start blinking simultaneously.

- 4) Press the WPS button on your communication device(e.g. router) within approximately one minute. Please refer to the manual of your communication device.

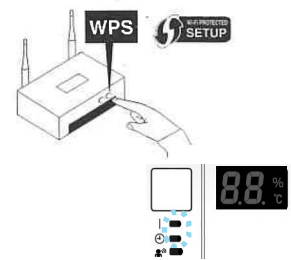
- Only Timer LED (Orange color) will blink, this will indicate successful connection between home router and machine.
- Operation & Timer LED (Green and Orange Colour) will blink continuously. If you fail to connect, refer to Note.



- 5) Press  button to return to the default screen of remote.
- 6) Open the DAIKIN AC MANAGER 2.0 MOBILE APP and select “Add Units” on Homescreen. Connect to your home network and then follow the on-screen instructions.
- 7) Connect your smart phone to your home network.
- 8) Open the Home screen of the DAIKIN AC MANAGER 2.0 MOBILE APP. The air conditioner will be listed there (Fig.1).

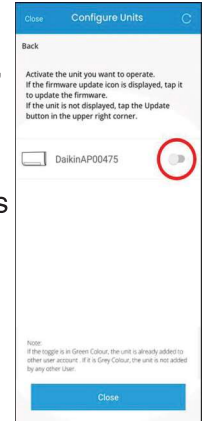

Fig.1

## NOTE

### Note on simple connection (WPS connection)

- If user did not connect within 3 minutes of Operation & Timer LED blinking, then Wi-Fi Module will not be able to connect with home router and user need to again start the SP2 process. Alternatively, try connecting via your device directly, Please refer to “Access point connection (AP connection)”

## Wi-Fi Operation

To connect the wireless LAN adapter with the home network, first turn ON the machine through main power supply. Turn Off the machine through remote, keep remote display ON while machine is turned OFF.

### ■ Access point connection (AP connection).

If your home Wi-Fi router does not have a WPS button, you can connect your smart phone directly to the wireless LAN connecting adapter in order to set up a connection to your home network by following these steps.

- This step requires SSID number and key located on the indoor unit.

### ■ To enable the wireless LAN connecting adapter:

1) Press and hold the  button on the remote controller for about 5 sec.

2) Press  or  button and select number 1.

- “SP” appears on the LCD.

- “” blinks.

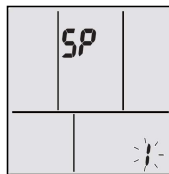

3) Press  to confirm the selected setting.

Timer LED (Orange) and Operation LED (Green) will blink Alternatively during the AP Connection for 3 minutes.

4) Connect the wireless LAN connecting adapter to a smart phone. View available Wi-Fi networks on your smart phone or tablet and select the SSID (Daikin AP\*\*\*\*) printed on the sticker. SSID and KEY are located on the indoor unit, as shown in the below image.

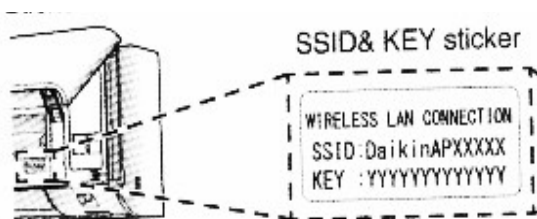

5) Press  to return to the default screen.

6) Open the DAIKIN AC MANAGER 2.0 MOBILE APP and select “Add Units” (Fig.2) and connect to your home network as per the on-screen instructions.

7) Connect your smart phone to your home network.

8) Open the Home screen of the DAIKIN AC MANAGER 2.0 MOBILE APP  
The air conditioner will be listed there.

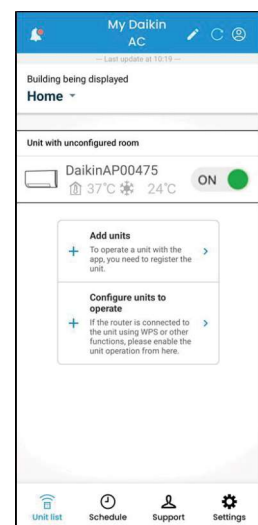
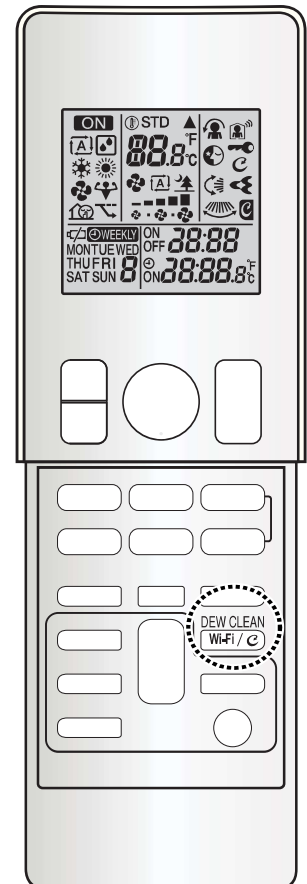

Fig.2

### NOTE

- Once the connection between wireless LAN connecting adapter & router is established successfully, the timer LED will blink.

## Wi-Fi Operation

### ❑ Reset connection setting to factory defaults.

To reset the wireless LAN connection, firstly turn ON the machine through main power supply. Turn Off the machine through remote, keep remote display ON while machine is turned OFF. Please note

When the device is reset, machine will forget already saved home router password.

All previous setting/data of wireless LAN would be lost and user needs to re-add the machine.

### ■ To reset

1) Press and hold  for 5 seconds on the default screen.

2) Press  or  button and select option **R**.

- “SP” appears on the LCD.
- “R” Blinks.

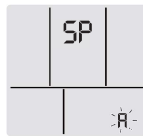

3) Press and hold  button for 2 seconds to confirm the selected setting.

4) Operation & Timer LED will blink simultaneously for approximately 3 min.

5) Press  to return to the default screen.

### ■ To disable the wireless LAN connecting adapter

To disable the wireless LAN connecting adapter to home network, make sure the unit is turned Off through remote and keep remote display ON while machine is turned OFF

1) Press and hold  button on remote controller for about 5sec.

2) Press  or  button and select option OFF.

- “SP” appears on the LCD.
- “OFF” Blinks.

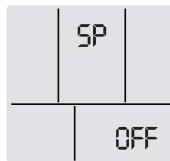

3) Press and hold  button for 2 seconds to confirm the selected setting.

4) Operation & Timer LED will blink alternatively for 1 min.

5) Press  button to return to the default screen.

## NOTE





- 1) If remote batteries are removed/replaced during wireless LAN enable or disable process then remote controller will forget previous setting and user need to again perform enable or disable process.
- 2) If the Wi-Fi module is already connected to your home network and the user attempts to repeat the WPS connection or AP connection method, then blinking pattern may differ.
- 3) In case there is no connection or disconnection between Wi-Fi Module and Indoor PCB, and then if user try to connect through WPS or AP connection methods, then machine will not show any blinking.
- 4) Daikin AC Manager 2.0 Mobile Application is available free of charge for the first two years from the date of account activation. After this period, continued use of the app will require a subscription, with applicable charges as per the chosen plan.



## DEW CLEAN Operation

- Dew Clean function aids in cleaning the accumulation of dust and stains on the Indoor Heat Exchanger.

### ■ To start the Dew Clean operation :

- Using the remote, turn on the air conditioner.
- Press, hold and release the " " button for a duration between 2 to 9 seconds.
- The " " symbol shall blink four times on remote LCD screen and remain visible in the LCD display.
- After the completion of blinking by the " " symbol, the LCD display shall return to normal. The ON symbol "ON", the fan symbol with Auto Fan speed " ", and the Dew Clean symbol " " shall remain on the LCD display for the entire duration of the Dew Clean function operation (Refer to image 1)

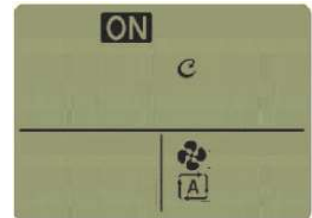
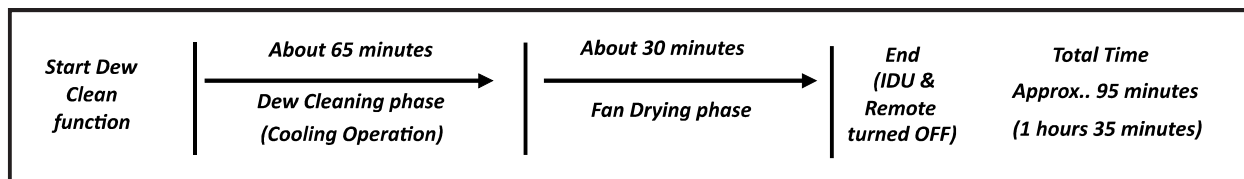



Image 1

### ■ To check the Dew Clean operation :

- During the operation, the LED indicator lamp (green and orange) on the indoor unit shall blink simultaneously.
- The operation stops automatically according to the defined process, and the unit shall be switched off after the completion of the Dew Clean operation.



### ■ To cancel the Dew Clean operation :

- Press, hold, and release the " " button for a duration between 2 to 9 seconds, or alternatively, use the "On/Off" button.
- Upon completion of the Dew Clean function (either by the stipulated time expiring or through cancellation of the operation), both the remote and the unit shall revert to the OFF state, restoring them to the state they were in before the Dew Clean function was activated.

### ■ Notes on the Dew Clean operation:

- 1) Users are recommended to turn OFF others features (like Intelligent Eye , ON/OFF Timer, Good Sleep etc.) operation before turning "ON" Dew Clean operation.
- 2) During the Dew Clean operation, all buttons except Power, Streamer, and Dew Clean shall be non-operable.
- 3) The Dew Clean operation automatically controls temperature and airflow rate, rendering manual adjustments of these functions unavailable.
- 4) In case of a main power reset or power failure, the Dew Clean operation will come to an end.
- 5) It is recommended that users avoid staying inside the room during the Dew Clean operation, as the indoor temperature will be lower.
- 6) If the user removes and reinserts the battery while using the Dew Clean function, the Dew Clean feature is turned OFF on the remote.
- 7) The function will not operate if the room temperature is lower than 10°C.
- 8) To ensure easy identification of the Dew Clean mode, it is advisable to keep the LED lights in the "ON" state using the Brightness control feature before starting the Dew Clean operation.
- 9) The Dew Clean feature cannot be applied if the remote is in brightness control mode, fault diagnosis mode, construction mode, jumper setting, trial mode, or inspection and commissioning mode. To activate the Dew Clean feature, it is necessary to first exit from the other selected mode.
- 10) Using this function once a month is recommended to achieve better cooling effects.
- 11) This function is recommended to operate at a temperature exceeding 24°C.
- 12) This function is available in both COOL and DRY modes of operation.

# Care and Cleaning

## CAUTION

- Before cleaning, be sure to stop the operation and turn off the circuit breaker.
- Do not touch the aluminium fins of the indoor unit. If you touch those parts, this may cause an injury.
- When removing or attaching the front panel, stand on a solid, stable base and take care not to fall.
- When removing or attaching the front panel, support the panel securely with your hand to prevent it from falling.

## Units

### ■ Indoor unit and remote controller

1. Wipe them with a dry soft cloth.

### ■ Front panel

1. Open the front panel.

- Hold the front panel by the indentations in the unit and open the front panel.

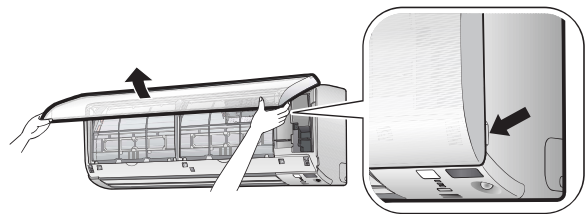

2. Remove the front panel.

- 1) Slide the front panel to either the left or right and pull it toward you to disengage one of the front panel shafts.
- 2) Disengage the front panel shaft on the other side in the same manner.
- 3) After disengaging both front panel shafts, pull the front panel toward yourself and remove it.

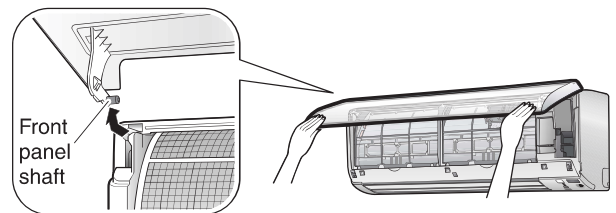

3. Clean the front panel.

- Wipe it with a soft damp cloth.
- Only neutral detergent may be used.
- In case of washing the panel with water, wipe it with a dry soft cloth, and let it dry in the shade after washing.

4. Attach the front panel.

- 1) Align the front panel shaft on the left and right of the front panel with the grooves, then push them all the way in.
- 2) Close the front panel slowly.
- 3) Press the front panel at both sides and the centre.
  - After cleaning, make sure that the front panel is securely fixed.

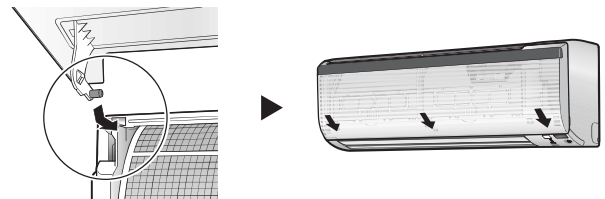

## NOTE

### For cleaning, do not use any of the following:

- Water hotter than 40°C
- Polishing compounds
- Volatile liquid such as benzene, petrol and thinner
- Rough materials such as a scrubbing brush



# Care and Cleaning

## Air filter

### 1. Pull out the air filters.

- Open the front panel.
- Push the filter tab at the centre of each air filter a little upwards, then pull it down.

### 2. Wash the air filters with water or clean them with a vacuum cleaner.

- It is recommended to clean the air filters every 2 weeks.
- If the dust does not come off easily, wash them with neutral detergent thinned with lukewarm water, then let them dry in the shade.

### 3. Reattach the filters and close the front panel.

- Insert the filters into slots of the front grille. Close the front panel slowly and push the panel at the 3 points.

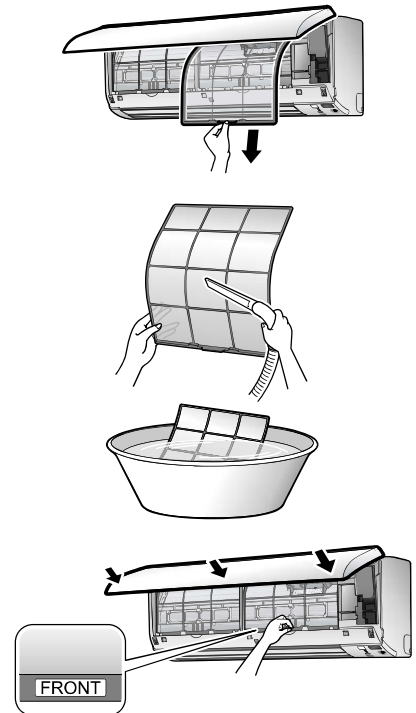

## Accessory filter for streamer unit

Filter type: Micro-filter (PM1.0) / Micro-filter (PM2.5)

### [Maintenance]

The accessory filter can be renewed by cleaning it with a vacuum cleaner once every 6 months. We recommend replacing it once every 6.5 years.

### 1. Take off the accessory filter.

- 1) Open the front panel and pull out the air filters.
- 2) Take off the accessory filter.
  - Remove the accessory filter from the tabs.

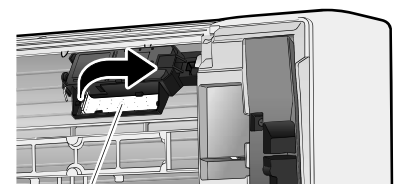

Accessory filter

### 2. Vacuum dust.

- Do not wash the accessory filter as this will reduce its efficiency.

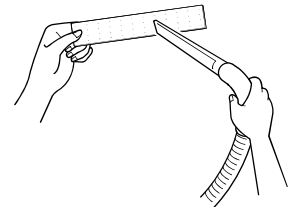

### [Replacement]

### 1. Replace the old accessory filter with a new accessory filter.

# Care and Cleaning

## Accessory filter for front grille (sold separately)

Filter type: Micro-filter (PM 2.5)

Accessory filters can also be attached to the front grille.

### [Attaching]

1. Open the front panel and pull out the air filters. [▶Page 25, 26](#)
2. Set the accessory filters under the tabs of the filter frame on the indoor unit.

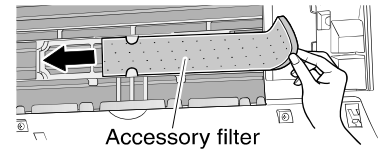

### [Maintenance]

The accessory filters can be renewed by cleaning it with a vacuum cleaner once every 6 months. We recommend replacing them once every 3 years.

#### 1. Take off the accessory filters.

- 1) Open the front panel and pull out the air filters. [▶Page 25, 26](#)
- 2) Take off the accessory filters.
  - Remove the accessory filters from the tabs.

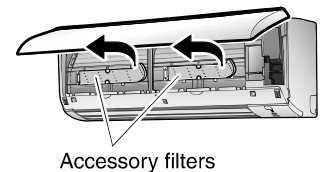

#### 2. Vacuum dust.

- Do not wash the accessory filters as this will reduce their efficiency.

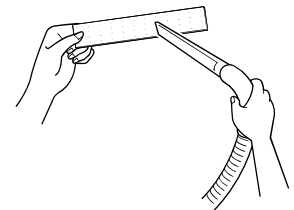

### [Replacement]

1. Replace the old accessory filters with new accessory filters.

## Accessory filter for front grille (sold separately)

Filter type: Titanium apatite deodorizing air-purifying filter

Accessory filters can also be attached to the front grille.

### [Attaching]

- Refer to the procedures above for attaching the filters.

### [Maintenance]

The accessory filters can be renewed by washing them with water once every 6 months. We recommend replacing them once every 3 years.

#### 1. Take off the accessory filters.

- Refer to the procedures above for removing the filters.

#### 2. Vacuum dust and soak in lukewarm water or water for about 10 to 15 minutes if very dirty.

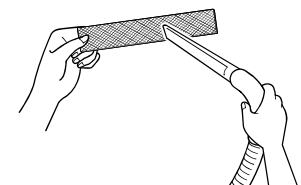

#### 3. After washing, shake off remaining water and dry in the shade.

- Do not wring out the accessory filters to remove water from them.



### [Replacement]

1. Replace the old accessory filters with new accessory filters.

# Care and Cleaning

## NOTE

- Dispose of the old filter as non-flammable waste.
- To order an accessory filter, contact your service centre.

| Item   | Part No.   |
|--|------------|
| Micro-filter (PM1.0) (for streamer unit) 1 no.                             | KAF100A507 |
| Micro-filter (PM2.5) (for streamer unit) 1 no.                             | KAF250A505 |
| Micro-filter (PM2.5) (for front grille) 1 set                              | KAF250A502 |
| Titanium apatite deodorizing air-purifying filter (for front grille) 1 set | KAF970A45  |

- Operation with dirty filter: (1) cannot deodorise the air. (2) cannot clean the air.  
(3) results in poor cooling. (4) may cause odour.

## ■ Prior to a long period of non-use

### 1. Operate the FAN mode for several hours on a fine day to dry out the inside.

1) Press  and select FAN operation.

2) Press  and start the operation.

### 2. After operation stops, turn off the circuit breaker for the room air conditioner.

### 3. Clean the air filters and set them again.

### 4. To prevent battery leakage, take out the batteries from the remote controller.

#### **We recommend periodical maintenance.**

In certain operating conditions, the inside of the air conditioner may get foul after several seasons of use, resulting in poor performance. It is recommended to have periodical maintenance by a specialist in addition to regular cleaning by the user. For specialist maintenance, please contact your service centre.

The maintenance cost must be borne by the user.

# Troubleshooting

## These cases are not problems.

The following cases are not air conditioner troubles but have some reasons. You may just continue using it.

| Case  | Explanation  |
|---|--|
| <b>Operation does not start soon.</b> <ul style="list-style-type: none"> <li>When "ON/OFF" button was pressed soon after operation was stopped.</li> <li>When the mode was reselected.</li> </ul> | <ul style="list-style-type: none"> <li>This is to protect the air conditioner. You should wait for about 3 minutes.</li> </ul>   |
| <b>Air does not come out.</b>   | <ul style="list-style-type: none"> <li>If the operation is started when the airflow setting is "Auto", the SMELL PROOF operation starts running to prevent unpleasant odour inside the indoor unit. Wait for about 1 minute. (Except when POWER CHILL operation is set) <a href="#">▶Page 12</a></li> </ul>  |
| <b>The flaps do not start swinging immediately.</b>   | <ul style="list-style-type: none"> <li>The air conditioner is adjusting the position of the flaps. The flaps will start moving soon.</li> </ul>  |
| <b>Operation stopped suddenly. (OPERATION lamp is on)</b>   | <ul style="list-style-type: none"> <li>To protect the system, the air conditioner may stop operating after sudden large voltage fluctuations. It automatically resumes operation in about 3 minutes. Voltage range protection: 130V-285V</li> </ul>  |
| <b>A sound is heard.</b>  | <ul style="list-style-type: none"> <li> <b>■ A sound like flowing water</b> <ul style="list-style-type: none"> <li>This sound is generated because the refrigerant in the air conditioner is flowing.</li> <li>This is a pumping sound of the water in the air conditioner and can be heard when the water is pumped out from the air conditioner during COOL or DRY operation.</li> </ul> </li> <li> <b>■ Blowing sound</b> <ul style="list-style-type: none"> <li>This sound is generated when the flow of the refrigerant in the air conditioner is switched over.</li> </ul> </li> <li> <b>■ Ticking sound</b> <ul style="list-style-type: none"> <li>This sound is generated when the cabinet and frame of the air conditioner slightly expand or shrink as a result of temperature changes.</li> </ul> </li> <li> <b>■ Clopping sound</b> <ul style="list-style-type: none"> <li>This sound is heard from the inside of the air conditioner when the exhaust fan is activated while the room doors are closed. Open the window or turn off the exhaust fan.</li> </ul> </li> </ul> |
| <b>The outdoor unit emits water or steam.</b>   | <ul style="list-style-type: none"> <li> <b>■ In COOL or DRY operation</b> <ul style="list-style-type: none"> <li>Moisture in the air condenses into water on the cool surface of the outdoor unit piping and drips.</li> </ul> </li> </ul>   |
| <b>The INTELLIGENT EYE sensor does not respond.</b>   | <ul style="list-style-type: none"> <li>The sensor is warming up for about 2 minutes after the power is turned on. Wait for a while.</li> <li>The sensor may not recognise small movements such as those made by sleeping persons or small children.</li> <li>The sensor may not work well if the indoor temperature is high.</li> <li>The sensor may not work well if the lens part of the INTELLIGENT EYE sensor is dirty. Clean it with a soft, dry cloth.</li> <li>In the event of a power failure, the position of the louvres is reset. Then, once the sensor detects the movement of people again, it directs the louvres at the area detected.</li> </ul>   |
| <b>Mist comes out of the indoor unit.</b>   | <ul style="list-style-type: none"> <li>This happens when unit cooling in high humidity or if unit exposed to excessive oil, dust due to this irregular temperature may occur.</li> </ul>   |
| <b>The indoor unit gives out odour.</b>   | <ul style="list-style-type: none"> <li>The room odour absorbed in the unit is discharged with the airflow. We recommend you to have the indoor unit cleaned. Please consult your service centre.</li> </ul>  |

# Troubleshooting

| Case   | Explanation  |
|--|--|
| The outdoor fan rotates while the air conditioner is not in operation. | <ul style="list-style-type: none"> <li>■ <b>Immediately after the air conditioner is stopped:</b> <ul style="list-style-type: none"> <li>• The outdoor unit fan continues rotating for about another 1 minute to protect the system.</li> </ul> </li> <li>■ <b>While the air conditioner is not in operation:</b> <ul style="list-style-type: none"> <li>• When the outdoor temperature is high, the outdoor unit fan may start rotating to protect the system.</li> </ul> </li> </ul>   |
| Remote controller does not work properly.                              | <ul style="list-style-type: none"> <li>■ <b>No remote controller signals are displayed.</b></li> <li>■ <b>The remote controller sensitivity is low.</b></li> <li>■ <b>The display is low in contrast or blacked out.</b></li> <li>■ <b>The display runs out of control.</b> <ul style="list-style-type: none"> <li>• The batteries are dying and the remote controller is malfunctioning. Replace both batteries with new, dry batteries (AAA).</li> </ul> </li> </ul> <p>For details, refer to “<b>To insert the batteries</b>” of this manual. <span style="background-color: black; color: white; padding: 2px;">▶Page 6</span></p> |

## Check again.

Please check again before requesting repairs.

| Case   | Explanation   |
|--|---|
| The air conditioner does not operate.<br>(OPERATION lamp is off) | <ul style="list-style-type: none"> <li>• Has the circuit breaker been tripped or the fuse blown?</li> <li>• Is there a power failure?</li> <li>• Are batteries set in the remote controller?</li> <li>• Is the timer setting correct?</li> </ul>  |
| The room does not cool down.                                     | <ul style="list-style-type: none"> <li>• Is the airflow rate setting appropriate?<br/>If the airflow rate setting is too low, increase it.</li> <li>• Is the set temperature appropriate?</li> <li>• Is the adjustment of the airflow direction appropriate?</li> <li>• Are the air filters dirty?</li> <li>• Is there anything blocking the air inlet or air outlet of the indoor unit or outdoor unit?</li> <li>• Is a window or door open?</li> <li>• Is the air conditioner in VARIABLE operation or GOOD SLEEP OFF TIMER operation?</li> </ul> |
| Operation stops suddenly.<br>(OPERATION lamp is blinking)        | <ul style="list-style-type: none"> <li>• Are the air filters dirty?<br/>Clean the air filters.</li> <li>• Is there anything blocking the air inlet or air outlet of the indoor unit or outdoor unit?<br/>Stop operation and after turning off the circuit breaker, remove the obstruction. Then restart operation with the remote controller. If the OPERATION lamp is still blinking, check the error code and consult your service centre.</li> </ul>   |
| An abnormal functioning happens during operation.                | <ul style="list-style-type: none"> <li>• The air conditioner may malfunction with lightning or radio waves. Turn off the circuit breaker, turn it on again and try operating the air conditioner with the remote controller.</li> </ul>   |

# Troubleshooting

**Call your service centre immediately.**

## **WARNING**

- When an abnormality (such as a burning smell) occurs, stop operation and turn off the circuit breaker. Continued operation in an abnormal condition may result in problems, electric shock or fire. Consult your service centre.
- Do not attempt to repair or modify the air conditioner by yourself. Incorrect work may result in electric shock or fire. Consult your service centre.

If one of the following symptoms takes place, call your service centre immediately.

- **The power cord is abnormally hot or damaged.**
- **An abnormal sound is heard during operation.**
- **The circuit breaker, a fuse, or the earth leakage circuit breaker cuts off the operation frequently.**
- **A switch or a button often fails to work properly.**
- **There is a burning smell.**
- **Water leaks from the indoor unit.**

Turn off the circuit breaker and call your service centre.

- **After a power failure**  
The air conditioner automatically resumes operation in about 3 minutes. You should just wait for a while.

- **Lightning**  
If there is a risk lightning could strike in the neighbourhood, stop operation and turn off the circuit breaker to protect the system.

## **Disposal requirements**



Your air conditioning product is marked with this symbol. This means that electrical and electronic products shall not be mixed with unsorted household waste.

Do not try to dismantle the system yourself: the dismantling of the air conditioning system, treatment of the refrigerant, of oil and of other parts must be done by a qualified installer in accordance with relevant local and national legislation.

Air conditioners must be treated at a specialized treatment facility for re-use, recycling and recovery. By ensuring this product is disposed of correctly, you will help to prevent potential negative consequences for the environment and human health. Please contact the installer or local authority for more information.

Batteries must be removed from the remote controller and disposed of separately in accordance with relevant local and national legislation.

# Troubleshooting

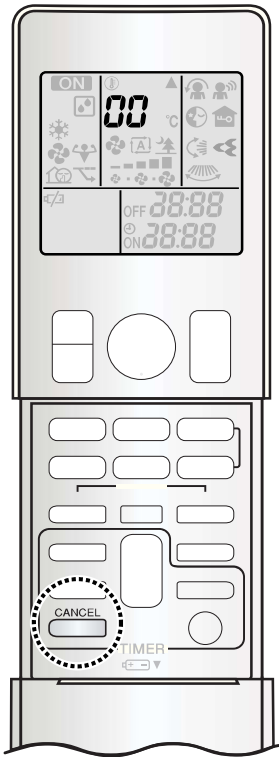

## Fault diagnosis by remote controller

The remote controller can receive relevant error codes from the indoor unit.

1. When **CANCEL** is held down for about 5 seconds, “00” blinks in the temperature display section.
2. Press **CANCEL** repeatedly until a long beep is produced.
  - The code indication changes as shown below, and notifies with a long beep.

|              | CODE  | MEANING   |
|--------------|---|---|
| SYSTEM       | 00  | NORMAL  |
|              | UA  | INDOOR-OUTDOOR UNIT COMBINATION FAULT                             |
|              | U0  | REFRIGERANT SHORTAGE  |
|              | U2  | DROP VOLTAGE OR MAIN CIRCUIT OVERVOLTAGE                          |
|              | U4  | FAILURE OF TRANSMISSION (BETWEEN INDOOR UNIT AND OUTDOOR UNIT)    |
| INDOOR UNIT  | A1  | INDOOR PCB DEFECTIVENESS  |
|              | A5  | FREEZE-UP PROTECTOR   |
|              | A6  | FAN MOTOR FAULT   |
|              | C4  | FAULTY HEAT EXCHANGER TEMPERATURE SENSOR                          |
|              | C9  | FAULTY SUCTION AIR TEMPERATURE SENSOR                             |
| OUTDOOR UNIT | E1  | CIRCUIT BOARD FAULT   |
|              | E5  | OL STARTED  |
|              | E6  | FAULTY COMPRESSOR START UP  |
|              | E7  | DC FAN MOTOR FAULT  |
|              | E8  | OVERCURRENT INPUT   |
|              | F3  | HIGH TEMPERATURE DISCHARGE PIPE CONTROL                           |
|              | F6  | HIGH PRESSURE CONTROL (IN COOLING)                                |
|              | F8  | OPERATION HALT DUE TO COMPRESSOR INTERNAL TEMPERATURE ABNORMALITY |
|              | H0  | SENSOR FAULT  |
|              | H6  | OPERATION HALT DUE TO FAULTY POSITION DETECTION SENSOR            |
|              | H8  | DC CURRENT SENSOR FAULT   |
|              | H9  | FAULTY SUCTION AIR TEMPERATURE SENSOR                             |
|              | J3  | FAULTY DISCHARGE PIPE TEMPERATURE SENSOR                          |
|              | J6  | FAULTY HEAT EXCHANGER TEMPERATURE SENSOR                          |
|              | L3  | ELECTRICAL PARTS HEAT FAULT                                       |
|              | L4  | HIGH TEMPERATURE AT INVERTER CIRCUIT HEATSINK                     |
| L5           | OUTPUT OVERCURRENT                                  |   |
| P4           | FAULTY INVERTER CIRCUIT HEATSINK TEMPERATURE SENSOR |   |

### NOTE

- A short beep indicates non-corresponding codes.
- To cancel the code display, hold down **CANCEL** for about 5 seconds.  
The code display also cancels itself if the button is not pressed for 1 minute.



# Quick Reference

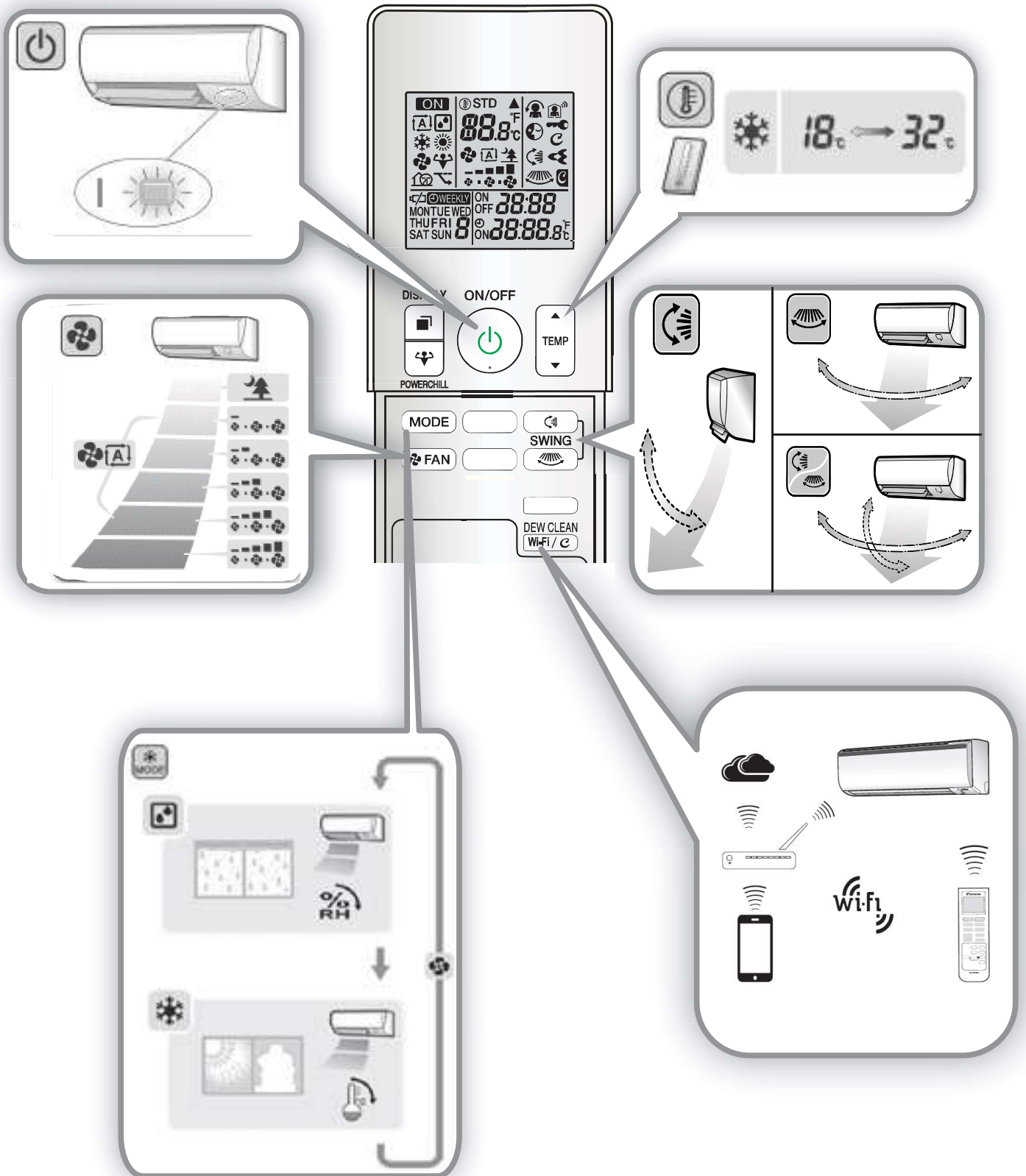

## **DAIKIN INDUSTRIES, LTD.**

Head office:  
Osaka Umeda Twin Towers South  
1-13-1, Umeda, Kita-ku, Osaka 530-0001, Japan

Tokyo office:  
Yaesu Central Tower, Tokyo Midtown Yaesu,  
2-2-1, Yaesu, Chuo-ku, Tokyo 104-0028, Japan  
<http://www.daikin.com>



DAIKIN ROOM AIR CONDITIONER

# INSTALLATION MANUAL



## MODELS



JTKJ35UV16WA

JTKJ50UV16VA



JTKJ60UV16UA

# Safety Precautions

- The precautions described herein are classified as **WARNING** and **CAUTION**. They both contain important information regarding safety. Be sure to observe all precautions without fail.
- Meaning of **WARNING** and **CAUTION** notices





|  |   |
|--|---|
|  <b>WARNING</b> | Failure to follow these instructions properly may result in personal injury or loss of life.  |
|  <b>CAUTION</b> | Failure to observe these instructions properly may result in property damage or personal injury, which may be serious depending on the circumstances. |

- The safety marks shown in this manual have the following meanings:

|   |   |  |
|---|---|--|
|  Be sure to follow the instructions. |  Be sure to establish an earth connection. |  Never attempt. |
|---|---|--|

- After completing installation, conduct a trial operation to check for faults and explain to the customer how to operate the air conditioner and take care of it with the aid of the operation manual.

## **WARNING**

- Ask your dealer or qualified personnel to carry out installation work.  
Do not attempt to install the air conditioner yourself. Improper installation may result in water leakage, electric shocks or fire.
- Install the air conditioner in accordance with the instructions in this installation manual. Improper installation may result in water leakage, electric shocks or fire.
- Be sure to use only the specified accessories and parts for installation work. Failure to use the specified parts may result in the unit falling, water leakage, electric shocks or fire.
- Install the air conditioner on a foundation strong enough to withstand the weight of the unit. A foundation of insufficient strength may result in the equipment falling and causing injury.
- Electrical work must be performed in accordance with relevant local and national regulations and with instructions in this installation manual. Be sure to use a dedicated power supply circuit only. Insufficiency of power circuit capacity and improper workmanship may result in electric shocks or fire.
- Use a cable of suitable length. Do not use tapped wires or an extension lead, as this may cause overheating, electric shocks or fire.
- Make sure that all wiring is secured, the specified wires are used, and that there is no strain on the terminal connections or wires. Improper connections or securing of wires may result in abnormal heat build-up or fire.
- When wiring the power supply and connecting the wiring between the indoor and outdoor units, position the wires so that the control box lid can be securely fastened. Improper positioning of the control box lid may result in electric shocks, fire or over heating terminals.
- If refrigerant gas leaks during installation, ventilate the area immediately.  
Toxic gas may be produced if the refrigerant comes into contact with fire. 
- After completing installation, check for refrigerant gas leakage. Toxic gas may be produced if the refrigerant gas leaks into the room and comes into contact with a source of fire, such as a fan heater, stove or cooker. 
- When installing or relocating the air conditioner, be sure to bleed the refrigerant circuit to ensure it is free of air, and use only the specified refrigerant (R32). The presence of air or other foreign matter in the refrigerant circuit causes abnormal pressure rise, which may result in equipment damage and even injury.
- During installation, attach the refrigerant piping securely before running the compressor. If the refrigerant pipes are not attached and the stop valve is open when the compressor is run, air will be sucked in, causing abnormal pressure in the refrigeration cycle, which may result in equipment damage and even injury.
- During pump-down, stop the compressor before removing the refrigerant piping. If the compressor is still running and the stop valve is open during pump-down, air will be sucked in when the refrigerant piping is removed, causing abnormal pressure in the refrigeration cycle, which may result in equipment damage and even injury.
- Be sure to earth the air conditioner.  
Do not earth the unit to a utility pipe, lightning conductor or telephone earth lead. Imperfect earthing may result in electric shocks. 
- Be sure to install an earth leakage circuit breaker. Failure to install an earth leakage circuit breaker may result in electric shocks or fire.
- Do not pump down when the refrigerant has leaked, otherwise the compressor may be damaged. 

## **CAUTION**

- Do not install the air conditioner at any place where there is a danger of flammable gas leakage.  
In the event of a gas leakage, build-up of gas near the air conditioner may cause a fire to break out. 
- While following the instructions in this installation manual, install drain piping to ensure proper drainage and insulate piping to prevent condensation. Improper drain piping may result in indoor water leakage and property damage.
- Tighten the flare nut according to the specified method such as with a torque wrench. If the flare nut is too tight, it may crack after prolonged use, causing refrigerant leakage.
- Take adequate steps to prevent the outdoor unit being used as a shelter by small animals.  
Small animals making contact with electrical parts can cause malfunctions, smoke or fire. Please instruct the customer to keep the area around the unit clean.
- The temperature of refrigerant circuit will be high, please keep the inter-unit wires away from copper pipes that are not thermally insulated.

## Accessories ㉠ ~ ㉠

| ITEM                                     | QTY. | Remarks | ITEM   | QTY. | Remarks |
|--|------|---------|--|------|---------|
| ㉠ Mounting plate                         | 1    | ○       | ㉠ Remote controller holder fixing screw (M3 x 20L) | 2    | ※       |
| ㉡ Mounting plate fixing screw (M4 x 25L) | 6/7* | ○       | ㉡ 4-Core wire (3.7M)                               | 1    | ※       |
| ㉢ Wireless Remote Controller             | 1    | ○       | ㉢ Tie wrap   | 6    | ※       |
| ㉣ Dry battery (AAA)                      | 2    | ※       | ㉣ Accessory filter                                 | 1/2* | ※       |
| ㉤ Indoor Unit Fixing Screw (M4 x 12L)    | 2    | ○       | ㉤ Gas pipe (3.0M)                                  | 1    | ※       |
| ㉥ Operation Manual + Installation Manual | 1+1  | ○       | ㉥ Liquid pipe (3.0M)                               | 1    | ※       |
| ㉦ E-Waste (Guideline)                    | 1    | ○       | ㉦ Drain socket                                     | 1    | ※       |
| ㉧ Product warranty                       | 1    | ○       | ㉧ Heat insulation tape                             | 1    | ※       |
| ㉨ Remote controller holder               | 1    | ※       | ㉨ Wi-Fi manual                                     | 1    | ※       |

\*○' Applicable for all models '※'Applicable only for selected models. '\*\*' Quantity may vary model to model.

Note: The accessories parts included with the unit displayed on the packing case name plate / Label of indoor and outdoor packing case

Table No. 1

## Precautions for Selecting a Location

- Before choosing the installation site, obtain user approval.

### Indoor unit

The indoor unit should be positioned in a place where:

- 1) the restrictions on the installation requirements specified in “**Indoor/Outdoor Installation Diagram**” are met,
- 2) both the air inlet and air outlet are unobstructed,
- 3) the unit is not exposed to direct sunlight,
- 4) the unit is away from sources of heat or steam,
- 5) there is no source of machine oil vapour (this may shorten the indoor unit service life),
- 6) cool air is circulated throughout the room,
- 7) the unit is away from electronic ignition type fluorescent lamps (inverter or rapid start type) as they may affect the remote controller range,
- 8) the unit is at least 1m away from any television or radio set (the unit may cause interference with the picture or sound),
- 9) the unit can be installed at the recommended height (1.8m),
- 10) no laundry equipment is nearby.

### Outdoor unit

The outdoor unit should be positioned in a place where:

- 1) the restrictions on the installation requirements specified in “**Indoor/Outdoor Installation Diagram**” are met,
- 2) drain water causes no trouble or problem in particular,
- 3) both air inlet and outlet have clear paths of air (they should be free of snow in snowy districts),
- 4) the unit is in a clear path of air but not directly exposed to rain, strong winds, or direct sunlight,
- 5) there is no fear of inflammable gas leakage,
- 6) the unit is not directly exposed to salt, sulfidized gases, or machine oil vapour (these may shorten the service life of the outdoor unit),
- 7) operating sound or hot airflow does not cause trouble to neighbours,
- 8) the unit is at least 3m away from any television or radio antenna.

## Outdoor Unit Installation Space Requirements

### ⚠ CAUTION

When carrying the outdoor unit during installation, wear gloves to avoid injury.

- Position the unit on a horizontal surface.  
Any tilt in the unit (front to back, right to left) should be 3° or less to the horizontal.
- Where a wall or other obstacle is in the path of the outdoor unit's intake or exhaust airflow, follow the installation space requirements below.
- For any of the below installation patterns, the wall height on the outlet side should be 1200mm or less.

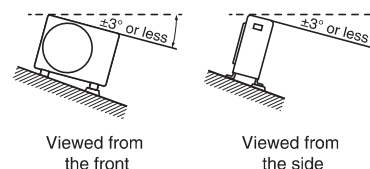

#### Wall facing one side

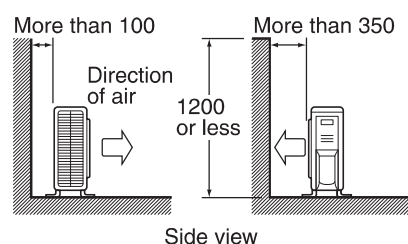

#### Walls facing two sides

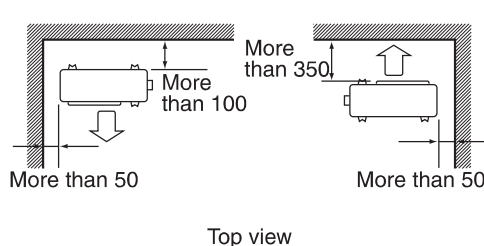

#### Walls facing three sides

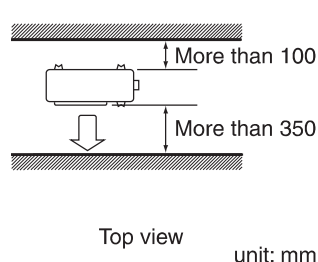

unit: mm

# Indoor/outdoor Unit Installation Diagram

- The mounting plate should be installed on a wall which can support the weight of the indoor unit.

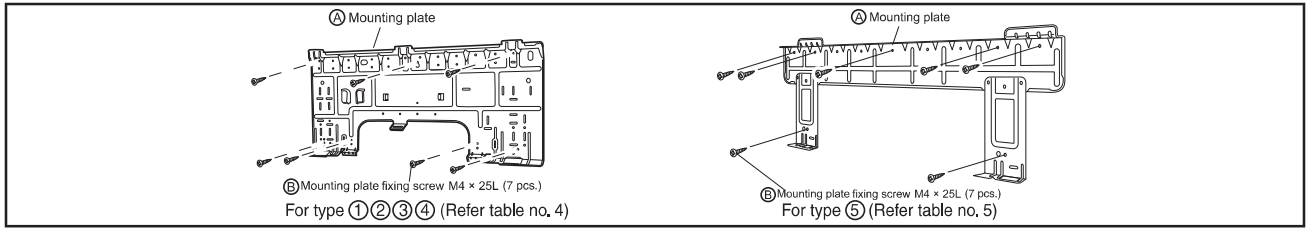

Note: Before installation, mounting plate size & shape must be matched with mounting plate available in the unit, then accordingly follow the installation instruction.

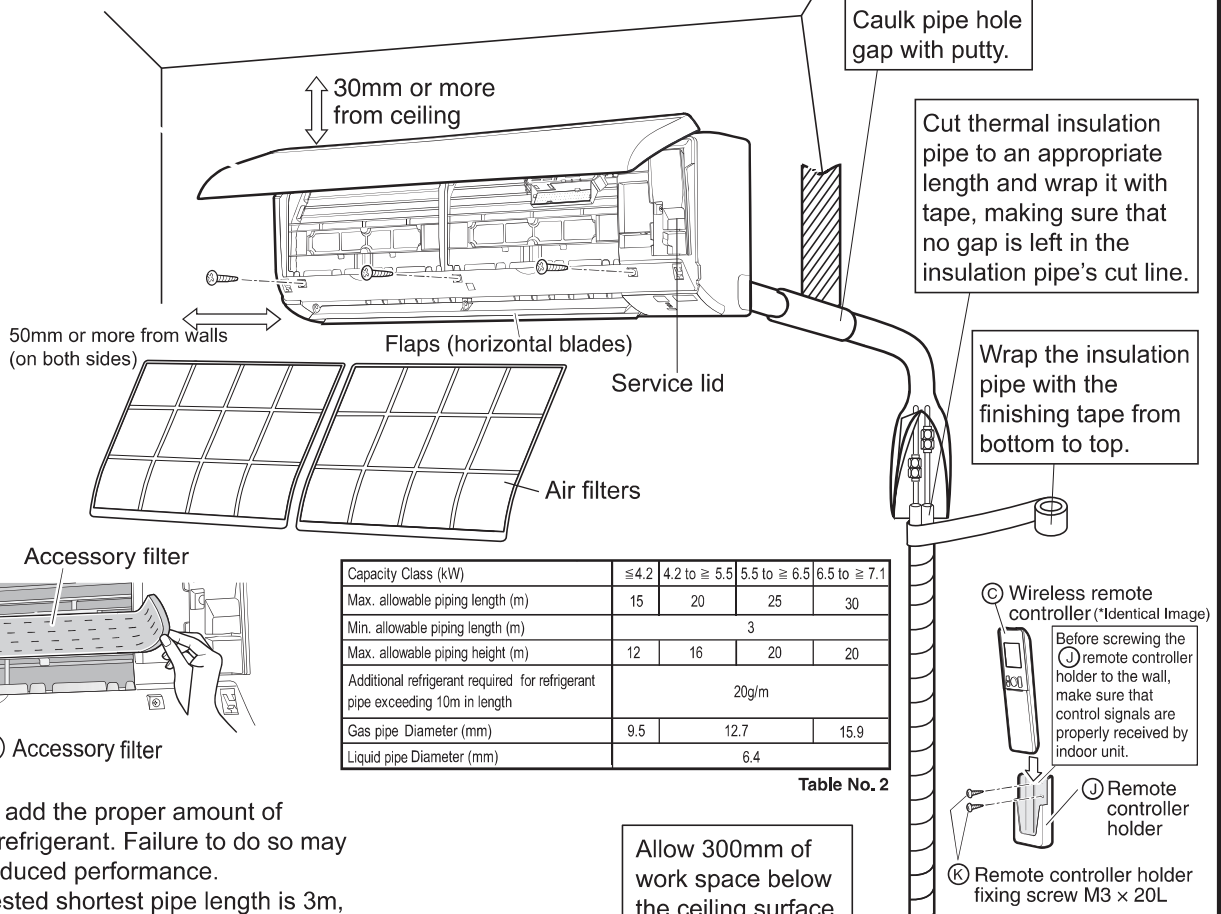

| Capacity Class (kW)  | ≤4.2  | 4.2 to ≥ 5.5 | 5.5 to ≥ 6.5 | 6.5 to ≥ 7.1 |
|--|-------|--------------|--------------|--------------|
| Max. allowable piping length (m)   | 15    | 20           | 25           | 30           |
| Min. allowable piping length (m)   | 3     |              |              |              |
| Max. allowable piping height (m)   | 12    | 16           | 20           | 20           |
| Additional refrigerant required for refrigerant pipe exceeding 10m in length | 20g/m |              |              |              |
| Gas pipe Diameter (mm)   | 9.5   | 12.7         | 15.9         |              |
| Liquid pipe Diameter (mm)  | 6.4   |              |              |              |

Table No. 2

- \* Be sure to add the proper amount of additional refrigerant. Failure to do so may result in reduced performance.
- \*\* The suggested shortest pipe length is 3m, in order to avoid noise from the outdoor unit and vibration. (Mechanical noise and vibration may occur depending on how the unit is installed and the environment in which it is used.)

| Dimensions of ODU installation leg* |                                       |       |       |     |
|-------------------------------------|---------------------------------------|-------|-------|-----|
| Type                                | Applicable unit size* [H] x [W] x [D] | A     | B     | C   |
| ①                                   | 418 x 695 x 244                       | 467   | 119.5 | 287 |
| ②                                   | 550 x 675 x 284                       | 470   | 97    | 308 |
| ③                                   | 550 x 765 x 285                       | 573.5 | 131   | 326 |
| ④                                   | 595 x 845 x 300                       | 574   | 105.5 | 311 |
| ⑤                                   | 695 x 930 x 350                       | 610   | 175   | 367 |

Table No. 3

In sites with poor drainage, use block bases for outdoor unit. Adjust foot height until the unit is leveled. Otherwise, water leakage or pooling of water may occur.

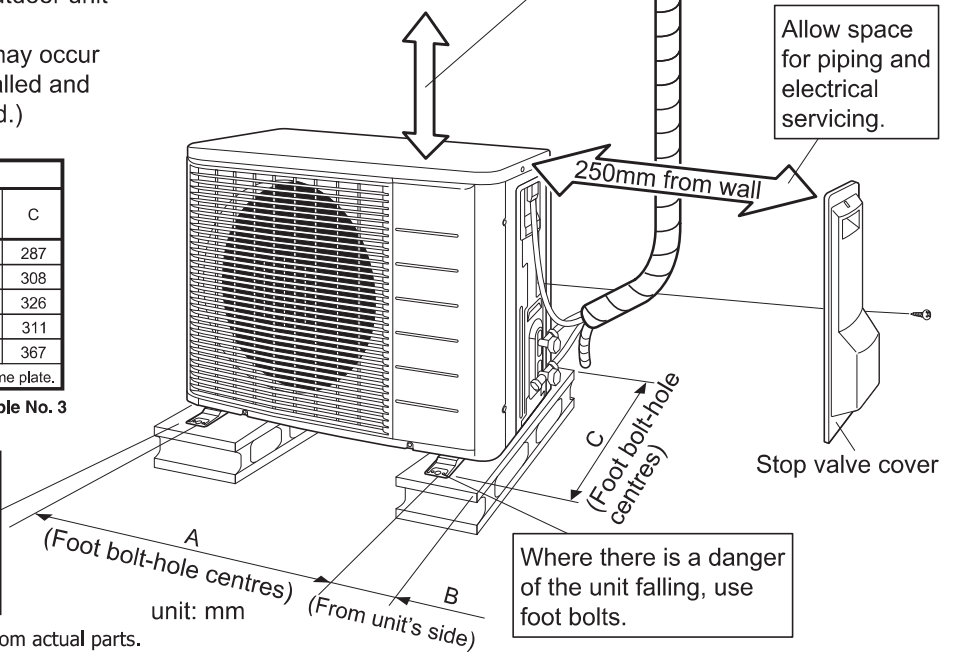

Note: All shapes or appearance may vary from actual parts.



# Installation Tips

## ■ Installing and Removing the indoor unit.

### • Installation method

Hook the claws of the bottom frame to the mounting plate. If the claws are difficult to hook, remove the front grille.

### • Removal method

Push up the marked area (at the lower part of the front grille) to release the claws. If it is difficult to release, remove the front grille.

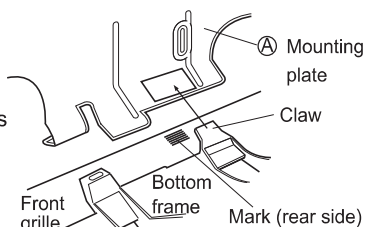

## ⚠ CAUTION

Do not hold the midsection of the bottom of the front grille when carrying the indoor unit.

## ■ Removing and installing the front panel.

### • Removal method

Hold the front panel by the indentations in the main unit and open the panel. Slide the front panel sideways to disengage the front panel shaft.

Then pull the front panel toward you to remove it.

You can also remove the front panel by pushing it open until the front panel shaft is disconnected.

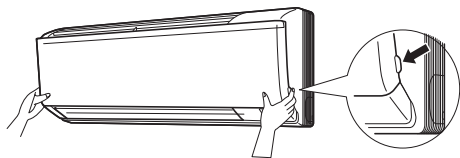

### • Installation method

Align the front panel shaft of the front panel with the grooves, and push all the way in. Then close slowly. Push the centre of the lower surface of the panel firmly.

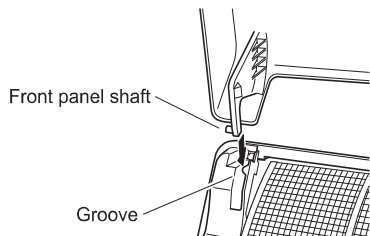

## ■ Removing and installing the front grille.

### • Removal method

- 1) Remove the front panel to remove the air filter.
- 2) Remove the flap (horizontal blade).
- 3) Remove the front grille. (3 screws)
- 4) In front of the ○○○ mark of the front grille, there are 3 upper hooks. Lightly pull the front grille toward you with one hand, and push down on the hooks with the fingers of your other hand.

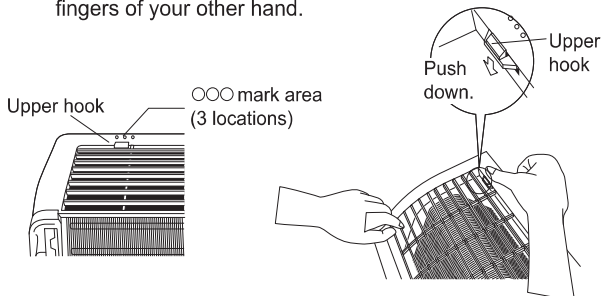

<When there is no work space because the unit is close to ceiling>

## ⚠ CAUTION

Be sure to wear protection gloves.

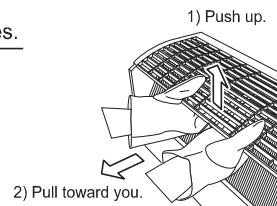

Place both hands under the centre of the front grille, and while pushing up, pull it toward you.

### • Installation method

- 1) Install the front grille and firmly engage the upper hooks (3 locations).
- 2) Install 3 screws of the front grille.
- 3) Install the air filter and then mount the front panel.

## ■ Opening the service lid.

The service lid is opening/closing type.

### • Opening method

- 1) Remove the service lid screws.
- 2) Pull out the service lid diagonally down in the direction of the arrow.
- 3) Pull down.

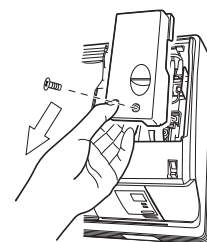

## ■ How to set the different addresses.

- 1) Remove the battery cover of the remote controller.
- 2) Cut the address jumper.
  - Be careful not to cut the left jumper.
- 3) Press the center of TEMP button and MODE button on the remote controller at the same time.
- 4) Select A (address setting) with TEMP▲ or TEMP▼ button.
- 5) Press MODE button to enter the address setting mode. Then, the indoor unit operation lamp blinks for 1 minute.
- 6) Press the indoor unit ON/OFF button while the operation lamp is blinking.
- 7) Press MODE button on the remote controller for 5 seconds to return to the normal mode.

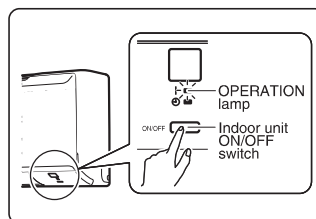
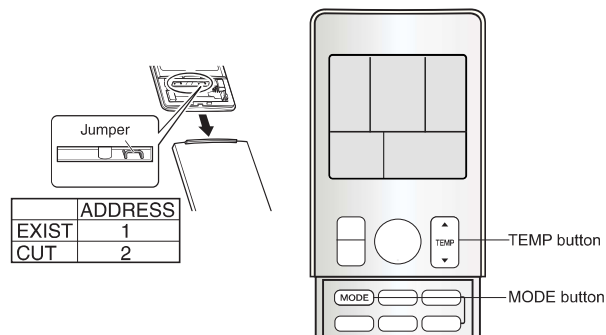

## ⚠ CAUTION

Replace the remote controller if you cut a jumper unintentionally

Jumper are necessary for electronic circuit. Improper operation may occur if you cut any of them.

# Indoor Unit

## 1 Installing The Mounting Plate

- The mounting plate should be installed on a wall which can support the weight of the indoor unit.
- Temporarily secure the mounting plate to the wall, make sure that the panel is completely level, and mark the boring points on the wall.
  - Secure the mounting plate to the wall with screws.

### Recommended mounting-plate retention spots and Dimensions

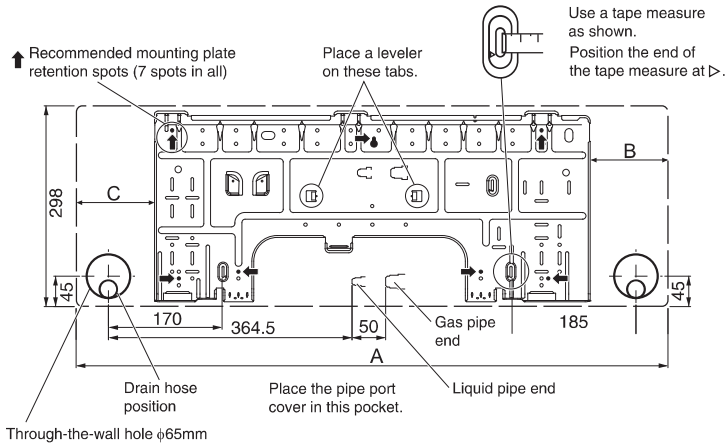

| Applicable Unit Size* |                 |     |       |       |
|-----------------------|-----------------|-----|-------|-------|
| Type                  | [H] X [W] X [D] | A   | B     | C     |
| ①                     | 298 x 800 x 229 | 800 | 116.5 | 116.5 |
| ②                     | 298 x 821 x 235 | 821 | 128   | 126.5 |
| ③                     | 298 x 885 x 229 | 885 | 116.5 | 116.5 |
| ④                     | 298 x 906 x 235 | 906 | 127   | 127.5 |

\* Unit size available on name plate.

Table No. 4

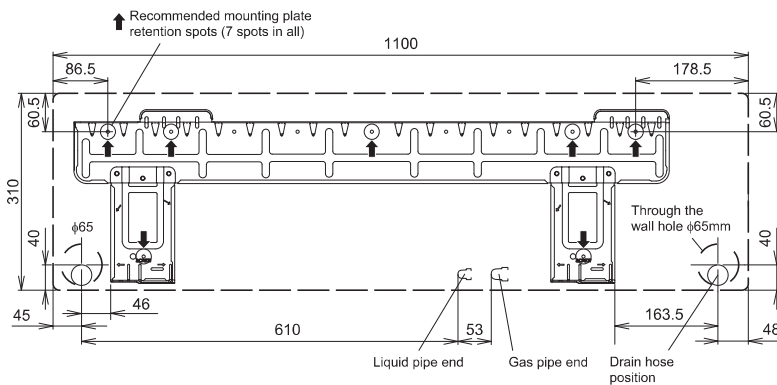

| Applicable Unit Size* |                  |
|-----------------------|------------------|
| Type                  | [H] X [W] X [D]  |
| ⑤                     | 310 x 1100 x 239 |

\* Unit size available on name plate.

Table No. 5

All dimensions are in mm.

## 2 Drilling A Wall Hole And Installing Wall Embedded Pipe

### ⚠ WARNING

For metal frame or metal board walls, be sure to use a wall embedded pipe and wall hole cover in the feed-through hole to prevent possible heat, electrical shock, or fire.

- Drill a feed-through hole with a 65mm diameter through the wall at a downward angle toward the outside.
- Insert a wall embedded pipe into the hole.
- Insert a wall hole cover into wall pipe.

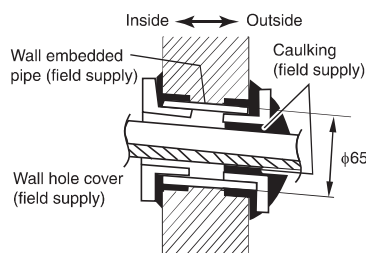

# Indoor Unit

## 3 Installing The Indoor Unit

### Right-Side, Right-Back or Right-Bottom Piping

- 1) Open the front panel, open the Front grille (If Required), then open the service lid. (Refer to Installation Tips.)
- 2) Shape the refrigerant pipes.
- 3) Pass the drain hose and refrigerant pipes through the wall hole.
- 4) Hang the indoor unit on (A) mounting Plate
- 5) Pass the inter-unit wires from the outdoor unit through the feed-through wall hole and then through the back of the indoor unit. Pull them through the front side. Bend the ends of tie wires upward in advance for easier work. (If the inter unit wires ends are to be stripped first, bundle wire ends with adhesive tape.)
- 6) Connect the refrigerant pipes.
- 7) Bind refrigerant pipe and drain hose with vinyl tape then wrap the refrigerant pipes and drain hose together with insulation tape (field supply) as shown in the figure.
- 8) Hook the claws of the bottom frame to the mounting plate, press the bottom frame of the indoor unit with both hands to set it on the (A) mounting plate hooks. Make sure the wire lead do not catch on the edge of the indoor unit.
- 9) Secure the indoor unit to the (A) mounting plate with the (E) indoor unit fixing screws (M4 x 12L).
- 10) Caulk the gap between the pipe and the front grille with putty.
- 11) After completing refrigerant piping, wiring and drain piping, caulk pipe hole gap with putty.

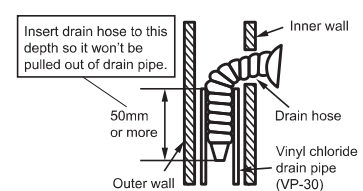
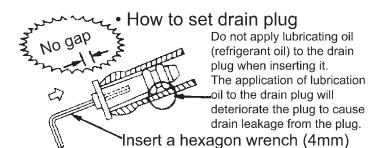
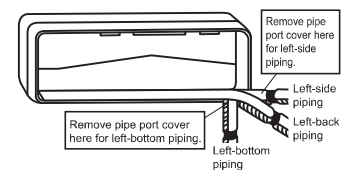
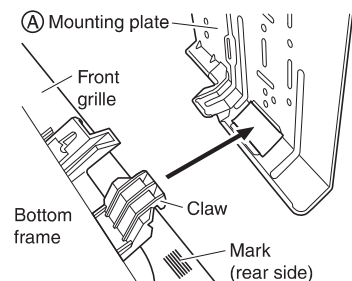
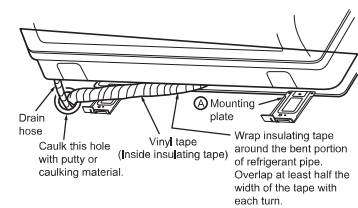
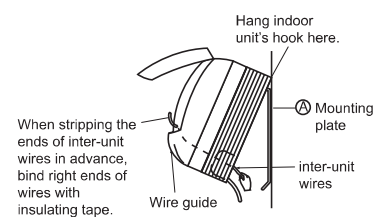
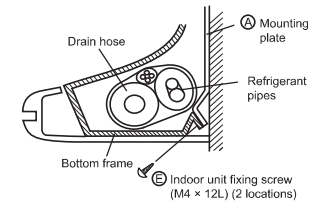
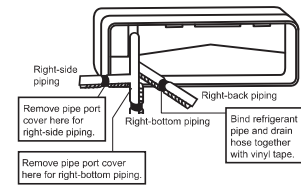

### Left-Side, Left-Back, or Left-Bottom Piping

For left piping addition things need to be taken care.

- 1) Be sure to connect the drain hose to the drain port in place of a drain plug.
- 2) Install the unit as per mentioned above RHS side.

### Well Embedded Piping

- 1) Insert the drain hose to this depth so it won't be pulled out of the drain pipe

# Indoor Unit

## 4 Wiring

- 1) Strip wire ends (15mm).
- 2) Match wire colours with terminal numbers on indoor and outdoor unit's terminal blocks and firmly screw wires to the corresponding terminals with the screw.
- 3) Connect the earth wires to the corresponding terminals.  
Attach the earth wire so that it is not connected to the fan motor connector.
- 4) Pull wires to make sure that they are securely latched up, then retain wires with wire retainer.
- 5) Shape the wires so that the service lid fits securely, then close service lid.

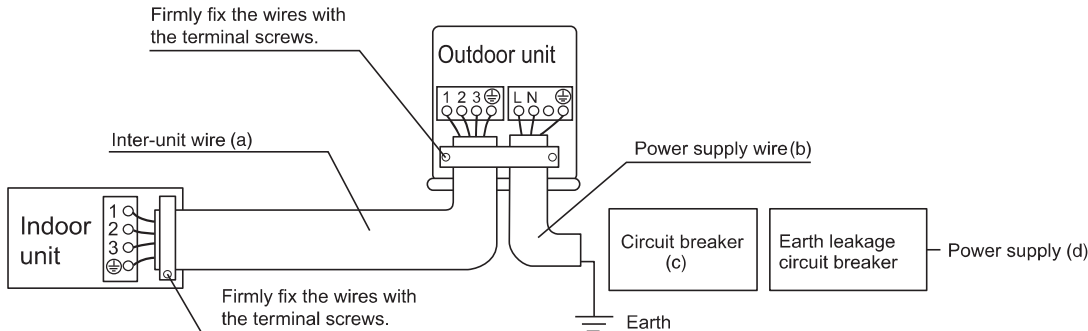
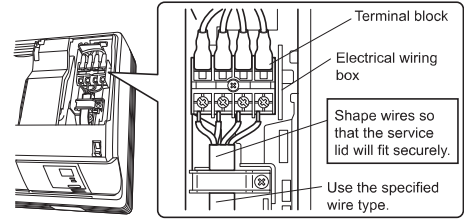

| Capacity Class (kW)      | 2.5~3.7                              | Above 3.7 and upto 7.1             | Above 7.1~9.15                      |
|--------------------------|--------------------------------------|------------------------------------|-------------------------------------|
| Inter Unit Wire (a)      | 4-core, 1.0 mm <sup>2</sup> or more  | 4-core, 1.5mm <sup>2</sup> or more |                                     |
| Power Supply wire (b)    | 3-core, 1.5mm <sup>2</sup> or more   |                                    | 3- core, 2.5mm <sup>2</sup> or more |
| Wire Standard            | IS:694 or country specific standard. |                                    |                                     |
| Circuit breaker size (c) | 15A or more                          | 20A or more                        |                                     |
| Power supply (d)         | 50Hz 230V~or Country specific        |                                    |                                     |

Note: Use 4-core 1.5mm<sup>2</sup> wire if wire is not included with the unit.

Table No. 6

### ⚠ WARNING

- Use a stabiliser if required by the voltage supply condition.
- Do not use tapped wires, extension cords, or starburst connections, as they may cause overheating, electrical shock, or fire.
- Do not use locally purchased electrical parts inside the product. (Do not branch the power for the drain pump, etc., from the terminal block.) Doing so may cause electric shock or fire.

## 5 Drain Piping

- 1) Connect the drain hose, as described right.
- 2) Remove the air filters and pour some water into the drain pan to check the water flows smoothly.
- 3) When drain hose requires extension, obtain an extension hose commercially available. Be sure to thermally insulate the indoor section of the extension hose.
- 4) When connecting a rigid polyvinyl chloride pipe (nominal diameter 13mm) directly to the drain hose attached to the indoor unit as with embedded piping work, use any commercially available drain socket (nominal diameter 13mm) as a joint.

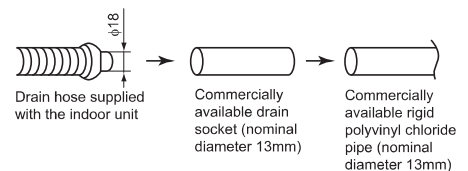
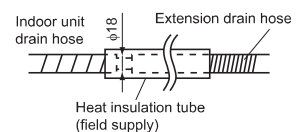
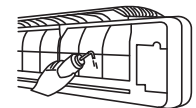
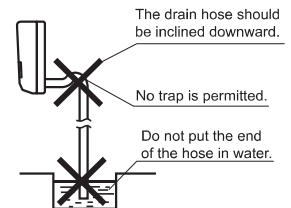

# Binding Of Insulation Pipe

1. The slit direction should be upward.
2. It should be sealed with vinyl tape without any gap.
3. Do not over tighten with vinyl tape.

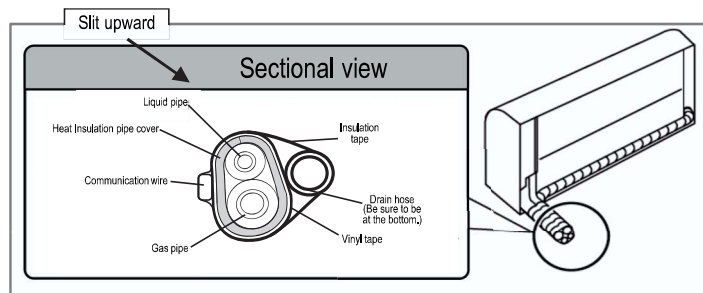

Wrap vinyl tape with the slit of the heat insulation pipe cover facing up so that there are no gap . If there is a gap or if it is tightened too much, it may cause condensation or water dripping.



This illustration shows the case of the left rear piping.

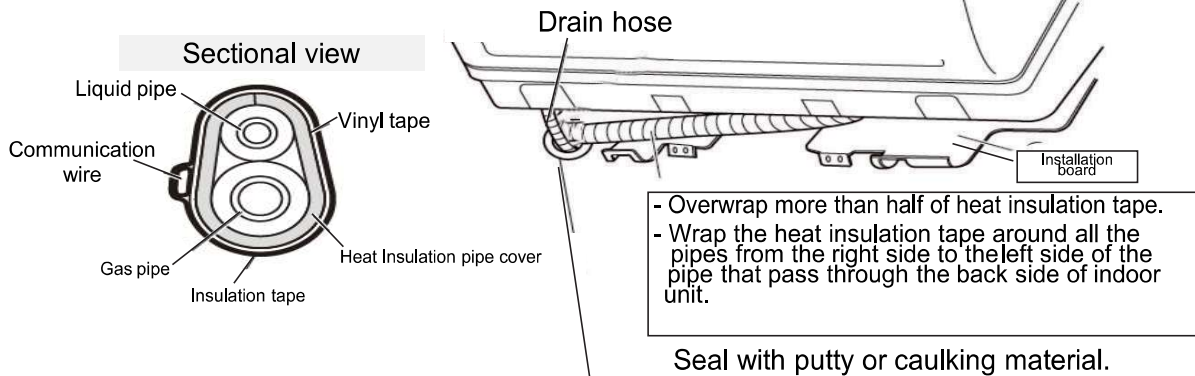

## ⚠ WARNING

Fill the gap from both the indoor side and the outdoor side to prevent dew condensation, misdetection of indoor temperature, and invasion of small animals.

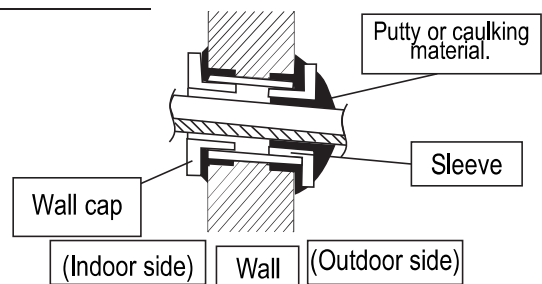

# Outdoor Unit

## 1 Installing The Outdoor Unit

- When installing the outdoor unit, refer to “Precautions for Selecting a Location” and the “Outdoor Unit Installation Diagram”.

## 2 Flaring The Pipe End

### ⚠ WARNING

Incomplete flaring may result refrigerant gas leakage.

- Cut the pipe end with a pipe cutter.
- Remove burrs with the cut surface facing downward, so that the fillings do not enter the pipe.
- Put the flare nut on the pipe.
- Flare the pipe.
- Check that the flaring has been done correctly.



**Flaring**

Set exactly at the position shown below.

| Flare tool for R410A/R32 | Conventional flare tool |                               |
|--------------------------|-------------------------|-------------------------------|
|                          | Clutch-type             | Wing-nut type (Imperial-type) |
| A                        | 0-0.5mm                 | 1.0-1.5mm                     |
|                          |                         | 1.5-2.0mm                     |

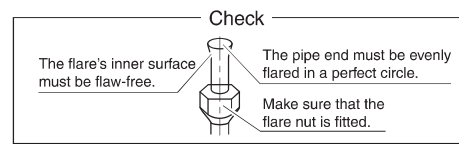

## 3 Refrigerant Piping

- To prevent gas leakage, apply refrigeration oil to the inner surface of the flare.
- Align the centres of both flares and tighten the flare nuts 3 or 4 turns by hand. Then tighten them fully with the torque wrenches.
  - Use torque wrenches when tightening the flare nuts to prevent damage to the flare nuts and escaping gas.

|             | Piping size  | Flare nut tightening torque          | Valve cap tightening torque          | Service port cap tightening torque   |
|-------------|--------------|--------------------------------------|--------------------------------------|--------------------------------------|
| Gas side    | O. D. 9.5mm  | 32.7-39.9N • m<br>(333-407 kgf • cm) | 21.6-27.4N • m<br>(220-280 kgf • cm) | 10.8-14.7N • m<br>(110-150 kgf • cm) |
|             | O. D. 12.7mm | 49.5-60.3N • m<br>(505-615 kgf • cm) | 48.1-59.7N • m<br>(490-610 kgf • cm) |                                      |
|             | O. D. 15.9mm | 61.8-75.4N • m<br>(630-770 kgf • cm) |                                      |                                      |
| Liquid side | O. D. 6.4mm  | 14.2-17.2N • m<br>(144-175 kgf • cm) | 21.6-27.4N • m<br>(220-280 kgf • cm) |                                      |

Table No. 7

### Cautions on Pipe Handling

- Protect the open end of the pipe against dust and moisture.
- All pipe bends should be as gentle as possible. Use a pipe bender for bending.

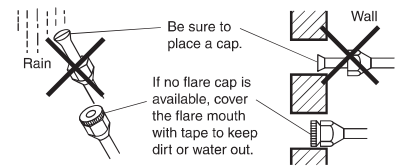

### Selection of Copper and Heat Insulation materials

When using commercial copper pipes and fittings, observe the following:

- Insulation material : Polyethylene foam or equivalent.  
Heat transfer rate - Co-efficient : 0.041 to 0.052W/m<sup>2</sup>K  
( 0.035 to 0.045kcal/m<sup>2</sup>h°C)

- Be sure to insulate both the gas and liquid piping and to provide insulation dimensions as below.

|             | Piping size | Minimum bend radius | Piping thickness               | Thermal insulation size | Thermal insulation thickness |
|-------------|-------------|---------------------|--------------------------------|-------------------------|------------------------------|
| Gas side    | O.D. 9.5mm  | 30 mm or more       | Thickness, 0.7mm<br>(C1220T-O) | I.D 12-15mm             | Thickness min.6.5mm          |
|             | O.D. 12.7mm | 40 mm or more       |                                | I.D 14-16mm             |                              |
|             | O.D. 15.9mm | 50 mm or more       |                                | I.D 16-20mm             |                              |
| Liquid side | O.D. 6.4mm  | 30 mm or more       | Thickness 0.6mm<br>(C1220T-O)  | I.D 8-10mm              |                              |

Table No. 8

- Use separate thermal insulation pipes for gas and liquid refrigerant pipes.

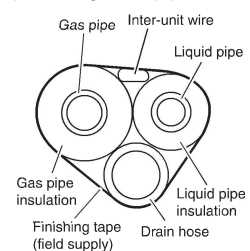



# Outdoor Unit

## 4 Purging Air And Checking Gas Leakage

### ⚠ WARNING

- Do not mix any substance other than the specified refrigerant (R32) into the refrigeration cycle.
- When refrigerant gas leaks occur, ventilate the room as soon and as much as possible.
- To prevent air pollution, a vacuum pump should be used for air purging wherever possible.

- If using additional refrigerant, perform air purging from the refrigerant pipes and indoor unit using a vacuum pump, then charge additional refrigerant.
- Use a hexagonal wrench to operate the stop valve rod.
- All refrigerant pipe joints should be tightened with a torque wrench at the specified tightening torque.

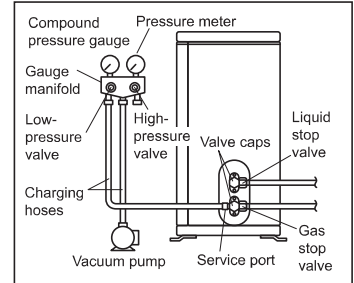

- 1) Connect projection side (on which pin is pressed) of charging hose (which comes from gauge manifold) to gas stop valve's service port.
- 2) Fully open gauge manifold's low-pressure valve (Lo) and completely close its high-pressure valve (Hi). (High-pressure valve subsequently requires no operation.)
- 3) Do vacuum pumping and make sure that the compound pressure gauge reads  $-0.1\text{MPa}$  ( $-76\text{cmHg}$ ) \*1.
- 4) Close gauge manifold's low-pressure valve (Lo) and stop vacuum pump. (Keep this state for a few minutes to make sure that the compound pressure gauge pointer does not swing back.) \*2.
- 5) Remove valve cap from liquid stop value and gas stop valve.
- 6) Turn the liquid stop valve's rod 90 degrees counterclockwise with a hexagonal wrench to open valve. Close it after 5 seconds, and check for gas leakage. Using soapy water, check for gas leakage from indoor unit's flare and outdoor unit's flare and valve rods. After the check is complete, wipe all soapy water off.
- 7) Disconnect charging hose from gas stop valve's service port, then fully open liquid and gas stop valves. (Do not attempt to turn valve rod beyond its stop.)
- 8) Tighten valve caps and service port caps for the liquid and gas stop valves with a torque wrench at the specified torques.

\*1. Pipe length vs. vacuum pump run time

| Pipe length | Up to 15m             | More than 15m         |
|-------------|-----------------------|-----------------------|
| Run time    | Not less than 10 min. | Not less than 15 min. |

\*2. If the compound pressure gauge pointer swings back, refrigerant may have water content or a loose pipe joint may exist. Check all pipe joints and retighten nuts as needed, then repeat steps 2) through 4).

## 5 Wiring

- For inter-unit wires connections, see **(INDOOR UNIT)**, **(4 WIRING)**.

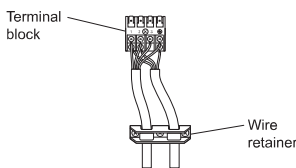

- Regarding the interconnecting and power cables.

### ⚠ WARNING

Never use short cables for connecting end of conductor to each other.

- When connecting the connection wires to the terminal block using a single core wire, be sure to perform curling. Problems with the work may cause heat and fires.

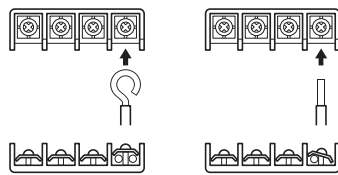

○ Good      × Wrong

Stripping wire at terminal block

- Precaution to be taken for power supply wiring.
- When using stranded wires, make sure to use a round crimp-style terminal for connection to the power supply terminal block. Place the round crimp-style terminals on the wires up to the covered part and secure in place.

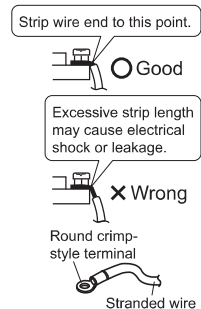

Strip wire end to this point.

○ Good

Excessive strip length may cause electrical shock or leakage.

× Wrong

Round crimp-style terminal

Stranded wire

## 6 Drain Work

- 1) Use the (R) drain socket for drainage.
- 2) When attaching the (R) drain socket to the bottom frame, make sure the connect the drain hose to the drain socket first.
- 3) If the drain port is covered by a mounting base or floor surface, place additional foot bases of at least 30mm in height under the outdoor unit's feet.
- 4) In cold areas, do not use a drain hose with outdoor unit. (Drain water may freeze, impairing heating performance.)

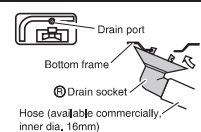



# Trail Operation And Testing

## 1. Trial operation and testing

- Check that the inter-unit wire is correctly connected.
- Trial operation should be carried out in COOL operation.
- 1-1 Measure the supply voltage and make sure that it is within the specified range.**
- 1-2 Select the lowest programmable temperature.**
- 1-3 Carry out the trial operation following the instructions in the operation manual to ensure that all functions and parts, such as the movement of the flaps, are working properly.**
- To protect the air conditioner, restart operation is disabled for 3 minutes after the system has been turned off.
- 1-4 After trial operation is complete, set the temperature to a normal level (26°C to 28°C in COOL operation, 20°C to 24°C in HEAT operation).**
- When operating the air conditioner in COOL operation in winter, or HEAT operation in summer, set it to the trial operation mode using the following method.
  - 1) Press "MODE" button and select the cooling or heating mode.
  - 2) Press "ON/OFF" button to turn on the system.
  - 3) Press both of "TEMP" button and "MODE" button at the same time.
  - 4) Press "TEMP" button, select "7", and press "MODE" button for confirmation.
- Trial operation will stop automatically after about 30 minutes. To stop the operation press "ON/OFF" button.
- The air conditioner draws a small amount of power in its standby mode. If the system is not to be used for some time after installation, shut off the circuit breaker to eliminate unnecessary power consumption.
- For products that are having wireless LAN adaptor would draw more power in standby mode as compared to products that are not having wireless LAN adaptor.
- If the circuit breaker trips to shut off the power to the air conditioner, the system will restore the original operation mode when the circuit breaker is turned on again.

## 2. Items to Check

| Test Items  | Symptom                     | Check |
|---|-----------------------------|-------|
| Indoor and outdoor units are installed securely.  | Fall, vibration, noise      |       |
| No refrigerant gas leaks.   | Incomplete cooling function |       |
| Refrigerant gas and liquid pipes and indoor drain hose extension are thermally insulated. | Water leakage               |       |
| Draining line is properly installed.  | Water leakage               |       |
| System is properly earthed.   | Electrical leakage          |       |
| Only specified wires are used for all wiring, and all wires are connected correctly.      | No operation or burn damage |       |
| Indoor or outdoor unit's air intake or exhaust has clear path of air.                     | Incomplete cooling function |       |
| Stop valves are opened.   | Incomplete cooling function |       |
| Indoor unit properly receives remote controller commands.                                 | No operation                |       |

## Pump Down Operation

### ⚠ WARNING

- Make sure that air or any matter other than refrigerant (R32) does not get into the refrigeration cycle.
- When performing a pump down, turn off the compressor before detaching the refrigerant pipes. (If the refrigerant pipes are detached when the compressor is operating and the stop valves are open, air will be drawn in leading to abnormally high pressure in the refrigeration cycle. This may result in rupturing and bodily injury.)

In order to protect the environment, be sure to pump down when relocating or disposing of the unit.

- 1) Remove the valve cap from the liquid stop valve and gas stop valve.
- 2) Begin forced cooling operation.
- 3) After 5 to 10 minutes, close the liquid stop valve with a hexagonal wrench.
- 4) After 2 to 3 minutes, close the gas stop valve and stop forced cooling operation.
- 5) Attach the valve cap once procedures are complete.

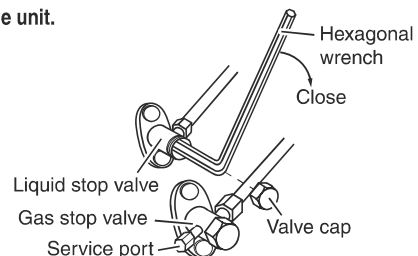

### Forced cooling operation

#### ■ Using the indoor unit ON/OFF switch

- Press and hold the indoor unit ON/OFF switch for at least 5 seconds. (The operation will start.)
- Forced cooling operation will stop automatically after about 15 minutes. To stop the operation, press the indoor unit ON/OFF switch.

**Disclaimer: Appearance of indoor & outdoor unit may differ between different models.**

DAIKIN ROOM AIR CONDITIONER

# MOBILE APPLICATION MANUAL



## MODELS

JTKJ35UV16WA  
JTKJ50UV16VA  
JTKJ60UV16UA

# INDEX

## Contents

|  |       |
|--|-------|
| 1. Safety Precautions  | 55-56 |
| 2. Process To Install And Open The App   | 57    |
| 3. Process For New User Registration   | 58    |
| 4. Process For New User Registration (Using Gmail ID)                            | 59    |
| 5. Process For New User Registration (Using Mobile Number)                       | 60    |
| 6. Process For New User Registration (Using Facebook ID)                         | 61-62 |
| 7. Process For Login   | 63    |
| 8. Process To Reset Forgot Password  | 64    |
| 9. App Homepage  | 65    |
| 10. Process For Editing Profile Details  | 66-67 |
| 11. Process For Editing The Building Name And Room Name                          | 68    |
| 12. Process for Registering unit to a Room of a Building                         | 69    |
| 13. Process To Add Air Conditioning Unit in the App (Add Unit Process)           | 70    |
| 14. Process To Add AC Unit in the Mobile App Using Access Point (AP) Mode Method | 71-72 |
| 15. Process To Add AC Unit in the Mobile App Using WPS/Simple Connection Method  | 73-74 |
| 16. Process To Update Firmware Of AC Wi-fi                                       | 75    |
| 17. Home Page - How To Start A Unit  | 76-77 |
| 18. Home Page After Multiple Units Are Added                                     | 78    |
| 19. Central Control  | 79    |
| 20. My Prefrence   | 80    |
| 21. Process To Configure Unit  | 81    |
| 22. Process To Change Home Router Network  | 82-83 |
| 23. Home Screen Details  | 84    |
| 24. How to use Control Screen  | 85    |
| 25. Operation Mode   | 86    |
| 26. Swing-UP & Down Swing ; Right & Left Swing                                   | 87    |
| 27. How to use Airflow Rate and Power Chill feature                              | 88    |
| 28. Coanda Operation   | 89    |
| 29. Dew Clean Operation  | 90-91 |
| 30. Streamer Operation   | 92    |
| 31. Intelligent Eye Operation  | 93    |

# INDEX

## Contents

|   |         |
|---|---------|
| 32. Variable Operation  | 94      |
| 33. Outdoor Quiet Operation   | 95      |
| 34. Electricity Consumption Feature   | 96-97   |
| 35. How To Use Schedule Feature   | 98-99   |
| 36. How To Use Schedule Feature On Multiple Units                           | 100     |
| 37. Support & Setting Section   | 101     |
| 38. Process To Remove An Added Unit   | 102     |
| 39. Notes   | 103     |
| 40. Daikin AC Manager 2.0 - Smart Speaker - Amazon Alexa                    | 104     |
| 41. Alexa App Overview  | 105-107 |
| 42. Alexa Device Setup (How to Connect Alexa Speaker with Alexa Mobile App) | 108-115 |
| 43. Alexa AC Connectivity (How to Connect Alexa Speaker with AC Unit)       | 116-124 |
| 44. How to Provide Command to Alexa – Smart Speaker                         | 125-126 |
| 45. Daikin AC Manager 2.0 Smart Speaker – Google Home                       | 127     |
| 46. Google Home App   | 128-131 |
| 47. Google Home App + Google Home Smart Speaker                             | 132-135 |
| 48. Google Home Smart Speaker + Daikin Smart App                            | 136-143 |
| 49. How to Provide Command to Google Home – Smart Speaker                   | 144-145 |
| 50. E-Waste Guidelines  | 146     |
| 51. Wiring Diagram (IDU)  | 147     |
| 52. Wiring Diagram (ODU)  | 148-150 |

# Safety Precautions

## Please be sure to follow the instructions mentioned below

This instruction manual described various ways to ensure safe use of Product.

Please read the text after carefully understanding the contents (display and graphic symbols) and follow the descriptions.

The contents caused by ignoring the "indication" and mishandling are classified as follows.

### • **WARNING**

It indicates "content that may result in death or serious injury."

### • **CAUTION**

It indicates "content that may cause injury or damage to property".

### • The types of contents to be protected are explained by dividing them into "graphic symbols".

 It represents "what not to do".

 It represents "what must be done".

### • **WARNING**

 **Do not disassemble, modify, or repair it.**  
(Causes of fire, electric shock, or injury)

 **Do not handle the connection adapter with wet hands.**  
(Causes of electric shock or fire)

 **Do not wet the main unit or use it in the bathroom.**  
(Causes of electric shock or fire)

- Do not use the connection adapter in the following places, or do not turn on the wireless LAN connection function of the device
- Places that may be used by people with cardiac pacemakers (may affect the operation of pacemakers, etc., and cause accidents)
- Near people with cardiac pacemakers or defibrillators (if they are too close, radio waves may affect the operation of the pacemaker, etc.)
- Near automatic control equipment such as automatic doors, fire alarms (causes of accidents due to equipment malfunctions)

 **If there is an abnormal odour, abnormal noise, overheating, or smoke, immediately unplug the equipment or turn off the breaker.**

(Cause of fire or malfunction)

Please have it inspected by the dealer where you purchased it.

➤ **If the connection adapter is dropped or the case is damaged, unplug the device or turn off the breaker.**

(Causes of fire or electric shock)

Please have it inspected by the dealer where you purchased it.

➤ **Make sure that the product is not installed in a place where flammable gas may leak.**

(In the unlikely event that gas leaks, it may cause a fire.)

### • **CAUTION**

 **Do not attach the connection adapter within reach of young children.**  
(Cause of injury)

➤ **When installing and cleaning the connection adapter, do not get on an unstable base.**

(Causes of injuries such as falls)

 **If you are using the following people, use it when there is someone nearby who can manage it. Infants, children, the elderly, sick people, people with physical disabilities**

(causes of physical illness)

• **Do not use the connection adapter near a microwave oven.**

(Causes affecting wireless LAN communication)

• **Do not use or store in the following locations:**

- In direct sunlight
- Places with poor ventilation.
- Places where rain, fog, etc. can enter directly
- Places with extreme high and low temperatures
- Dusty places

### [Precautions when using wireless LAN]

#### • About security settings

- Since wireless LANs use radio waves to transmit and receive data, there is a risk of eavesdropping and unauthorized access. When using wireless LAN, please fully understand the dangers and manage the wireless LAN connection adapter of the device, the SSID / KEY of the wireless router, and the "member information" set in the app so that others do not know it.
- In the unlikely event that the product is operated from outside the home due to unauthorized access, turn off the wireless LAN connection function using remote control.

# Safety Precautions

- **Before using the wireless router, set the security settings of the wireless router to "WPA2" encryption method.**
- **Please note that we are not responsible for any damage caused by the use of a wireless LAN router.**
- **About wireless LAN connection adapters and radio wave law**
  - There is no need to apply for a license because this wireless LAN connection adapter has a built-in wireless device that has obtained required certification.
- **This product cannot be directly connected to the communication lines of telecommunications carriers (e.g., Internet providers). When connecting to the Internet, be sure to connect via a router.**

## [Precautions for radio waves]

- **Use in the vicinity of other radios or microwave ovens may affect wireless communications.**
  - Remote control may not be available. Please check the safety of the product thoroughly before use.
- **Make sure that your device has a signal from the wireless router.**
  - Remote control may not be available. If the signal is weak in the vicinity of your device, please use it in a good radio wave environment, such as installing an access point in the vicinity.

## [Safety precautions when using the app]

- Please be sure to follow the instructions in this instruction manual and on the product in various ways to ensure safe use. Please read the text after carefully understanding the contents (display and graphic symbols) and follow the descriptions.
- **The contents caused by ignoring the "indication" and mishandling are classified as follows.**

### ➢ **WARNING**

It indicates "content that may result in death or serious injury."

- **The types of contents to be protected are explained by dividing them into "graphic symbols".**



It represents "what must be done".

### • **WARNING**



**When operating the device from outside the office, it is not possible to check the condition of the device, its surroundings and the people in the room. So make sure that it is safe in advance. In some cases, it may result in death, serious injury, or property damage.**

- **Check the following contents in advance (while at home)**
  - The power plug is securely plugged into the root. There is no dust accumulation on the power plug. (Causes of heat generation, ignition, or fire due to poor contact or insulation)
  - The status of settings set by others, such as timer scheduling. (Causes of illness due to unexpected driving or stopping.) Causes of adverse effects on flora and fauna)
  - There are no abnormalities in the equipment. Even if there is a change in the wind, it will not adversely affect people or rooms. (e.g., there are no items that are easy to fly, etc.) (Wind causes things to fall, causing fires, injuries, and damage to household goods)
  - Even if remote control is not possible, it will not adversely affect people or property.
    - If you need to operate it, use the remote control in your home.
    - If you are at home with an infant, a person with a disability, or an elderly person who cannot operate the remote control by yourself, or if there is a risk of incorrect operation, please operate it with the remote control in your home.
- **Check the following before and during operation from outdoors.**
- When you know people are around, let them know that you will be driving or stopping from outside. (If you are on a platform, you may be startled by sudden driving or stopping, causing you to fall or fall.) In addition, sudden changes in indoor and outdoor temperature and indoor environment can cause you to get sick) The temperature control and shutdown of the air conditioner can also be operated with a remote control in the home.
- Frequently check the settings and driving status.

Depending on the communication status, the contents of the operation on the smartphone may not be reflected on the device.  
When you know that there will be people, let them know that you will be doing an operation.  
If an error occurs with the equipment, stop operation immediately and consult the dealer where you purchased the product.  
Double-check that it is stopped on the operation screen.

## [Notice]

- The contents of the operation with the smartphone are not reflected on the display of the wireless remote control of the air conditioner.
- When operating the device from a smartphone, there is no reception sound from the device, but it is not a malfunction.

Depending on the model of the air conditioner, the outside air temperature is not displayed when the air conditioner is stopped. (-°C) is displayed.
- To prevent accidental operation, we recommend that you enable the auto-lock feature on your phone.
- Depending on your smartphone, the screen display may vary.
- iPhone is a trademark and registered trademark of Apple Inc.
- Android is a trademark or registered trademark of Google LLC.
- Other company names and product names are trademarks or registered trademarks of their respective companies.



# PROCESS TO INSTALL AND OPEN THE APP

- Download And Install the App Daikin AC Manager 2.0  from Google Play Store (Android OS) or iOS App Store.
- After installation, Open the App. User need to read and accept the License agreement .

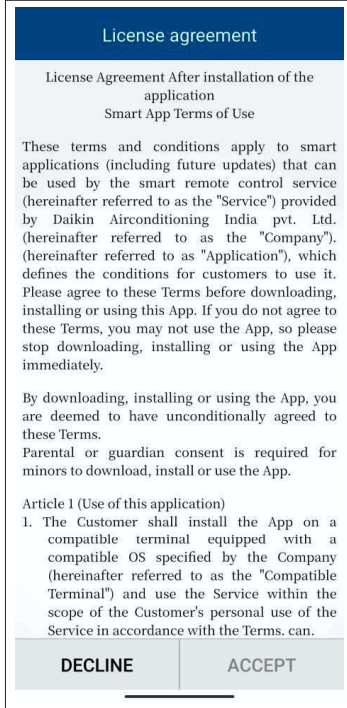

- License Agreement after installation of the application.
- User can read this License agreement by scrolling down.

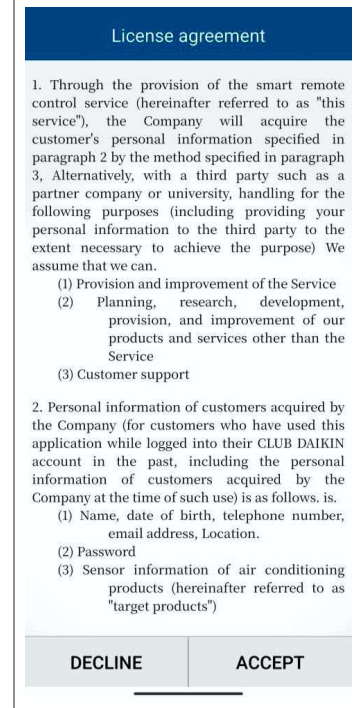

- User need to “Accept” the License agreement terms of use to proceed further.

# PROCESS FOR NEW USER REGISTRATION

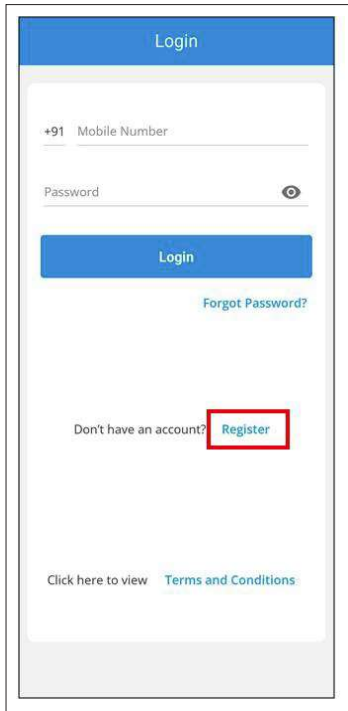

## Log in or Register

- New users need to "Register" before login.
- If user had already registered then user can login using their Mobile number and Password.

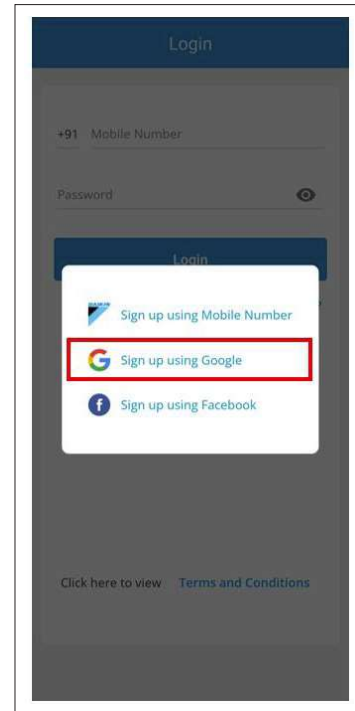

## Sign Up

- User can register or sign up using Mobile Number, Google or Facebook.
- If user wants to sign-up using Google, then user need to select the same.

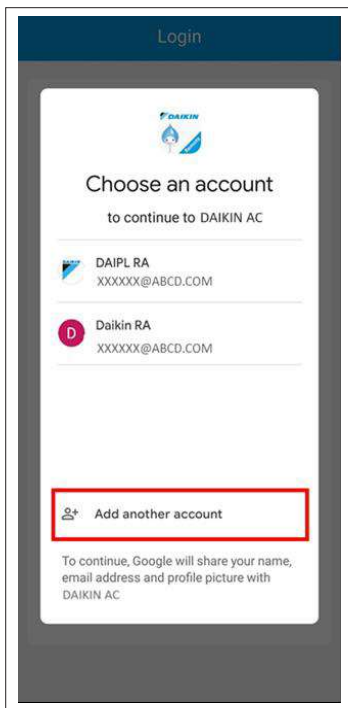

- Choose an existing Gmail account then user will be redirected to Daikin App Registration Page as shown in next page.
- Choose "Add another account" and follow as mentioned.

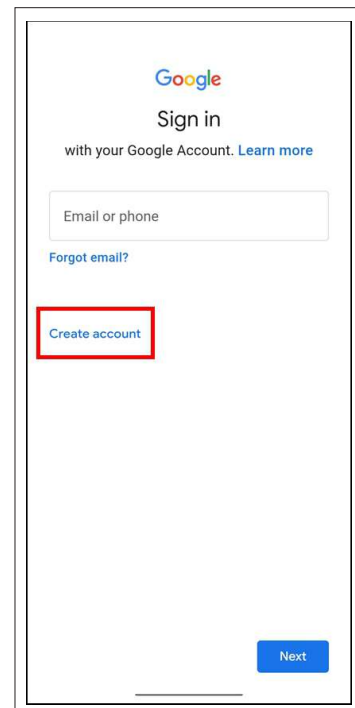

## Sign in or Create account on Google

- User can sign in using their Google Account or sign up by tapping on "Create account"

# PROCESS FOR NEW USER REGISTRATION (USING GMAIL ID)

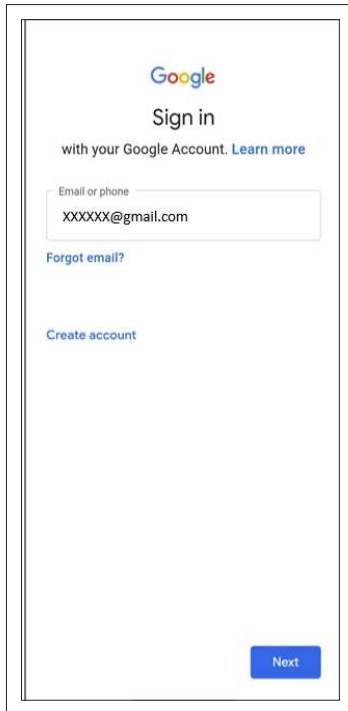

- Enter Email or phone number and tap on “Next”.



- Enter password and tap on “Next”.

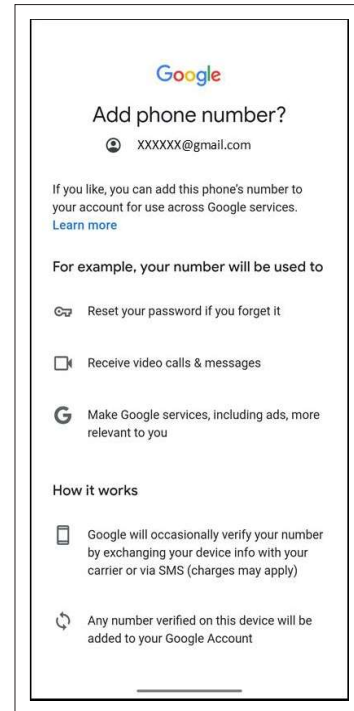

- User can add phone number to their Google account if already not added.
- Scroll down and read to the bottom.

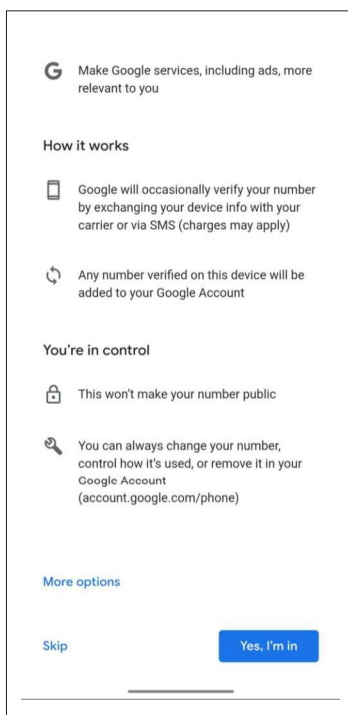

- Select “Yes, I'm in” if adding the number.
- Select “Skip” if not adding the number.

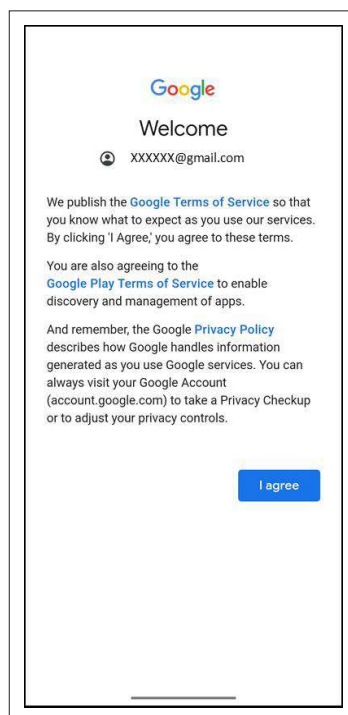

- Tap on “I agree” to complete the registration using Google.

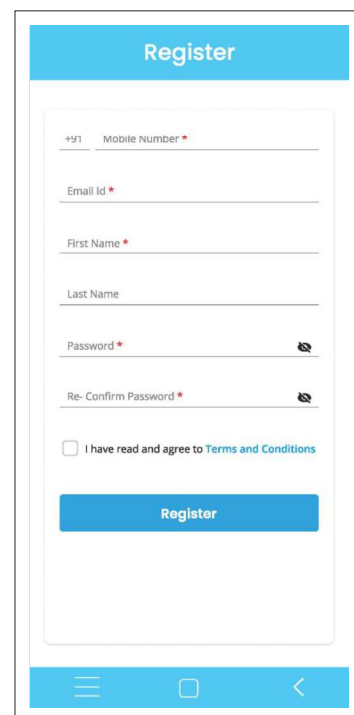

- User will be redirected back to the App.
- Email Id, First Name and Last Name will be auto-filled by Gmail account. User need to enter Mobile Number and set a password to complete the registration on Daikin App.

# PROCESS FOR NEW USER REGISTRATION (USING MOBILE NUMBER)



Sign up using Mobile Number

- Tap on "Sign up using Mobile Number".

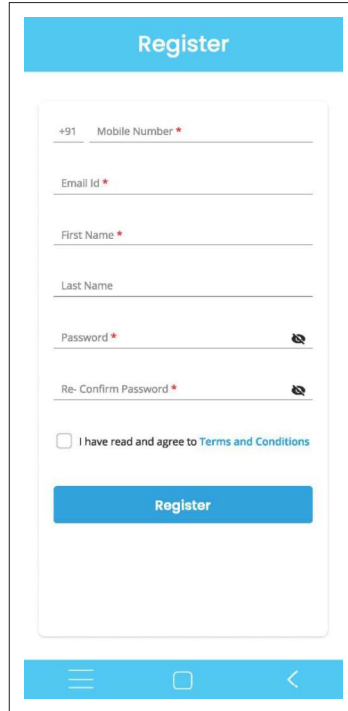

- Now, enter all the required details to complete the registration on Daikin app

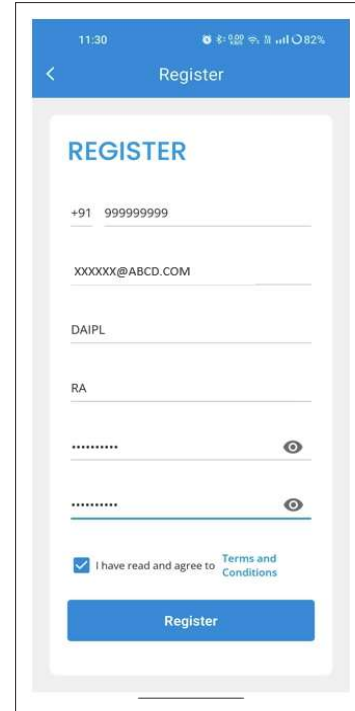

- User can read "Terms and Conditions" by tapping on it.
- Tick the "I have read and agree to "Terms and Conditions" and Register

# PROCESS FOR NEW USER REGISTRATION (USING FACEBOOK ID)

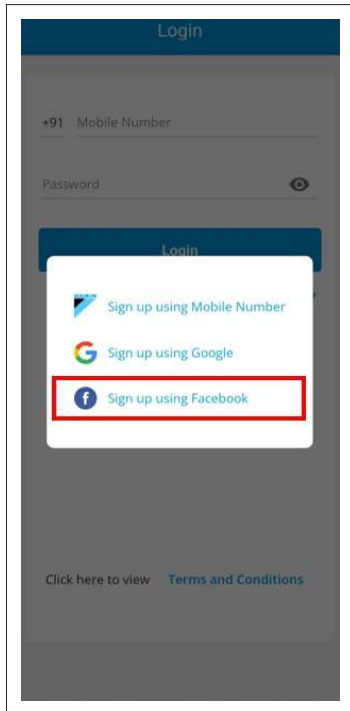

## Sign up using Facebook

- Tap on “**Sign up using Facebook**”.

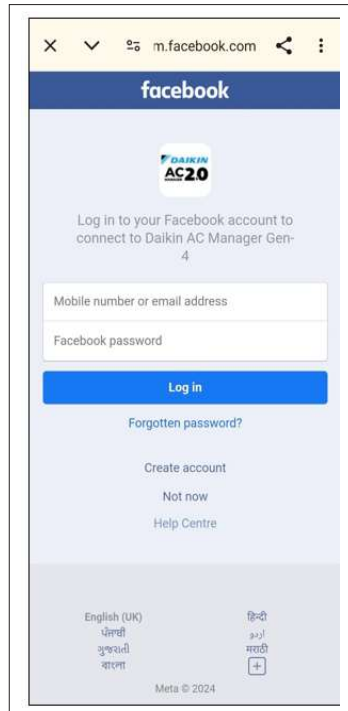

- User will be redirected to Facebook Login page.
- Enter registered **Mobile number or email address** and **password** to Login.

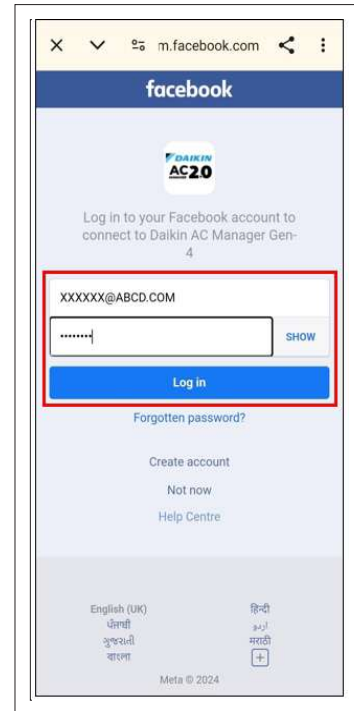

- After entering required login details, tap on “**Log In**”.

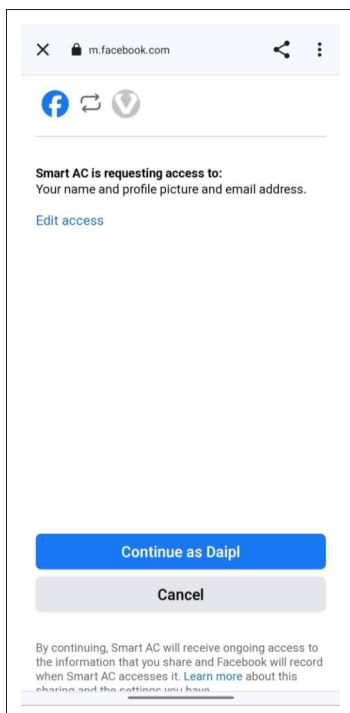

- User will be asked to give access to their name, profile picture and email address.
- Tap on **Continue** to proceed.

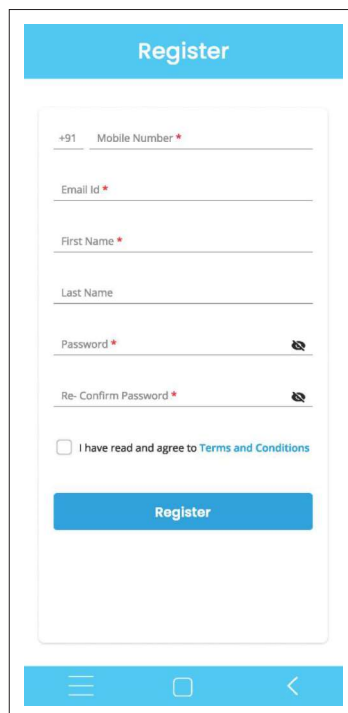

- User will be redirected to Daikin App to complete the registration.
- Email Id, First Name and Last Name will be auto-filled from Facebook account. User need to enter Mobile Number and set a password to complete the registration on Daikin App.

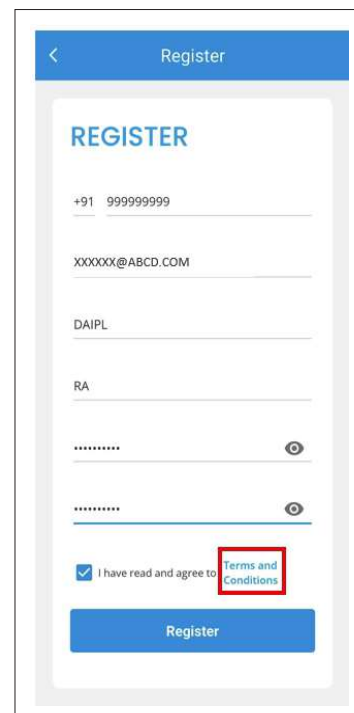

- User can read “**Terms and Conditions**” by tapping on it.
- Tick the “I have read and agree to Terms and Conditions” and Register

# PROCESS FOR NEW USER REGISTRATION (USING FACEBOOK ID)

- After entering all the required details, OTP would be send to registered phone number and email ID.
- Complete the verification by entering OTP to finish the registration.

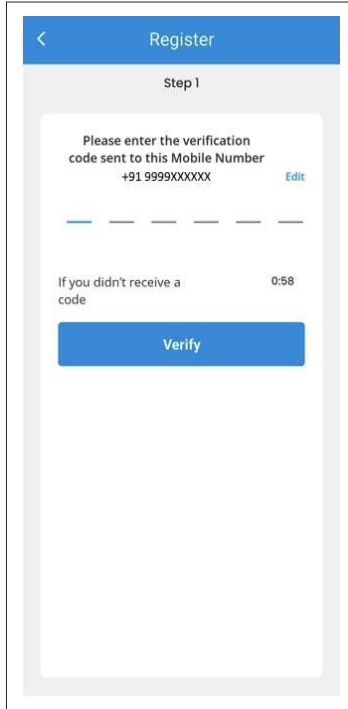

**Mobile Number Verification**

- App will automatically detect the OTP or user can enter manually.

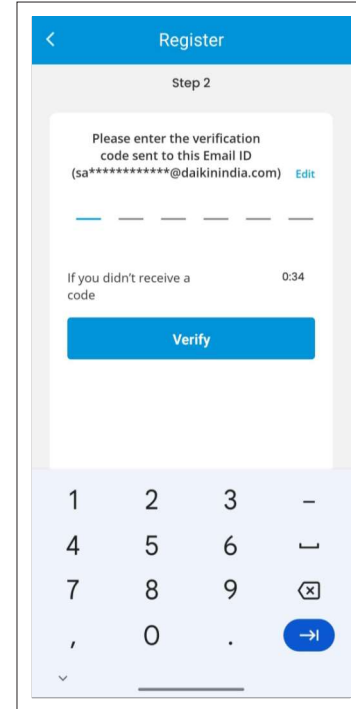

**Email ID Verification**

- User need to enter **OTP** manually received on registered Email ID.
- If OTP is not received within 60 seconds then user can again request for OTP.



# PROCESS FOR LOGIN

- After completing the registration and verification process, user can Login by entering registered mobile number and password.
- A password must contain at least 8 characters includes 1 lower & upper case, 1 digit and 1 special character.

## License Agreement when the login done

- User can read this License agreement by scrolling down.
- User need to Accept this License agreement to proceed further.

# PROCESS TO RESET FORGOT PASSWORD



- In case, user forgets the password.
- Tap on “Forgot Password?” on Log In page as shown.

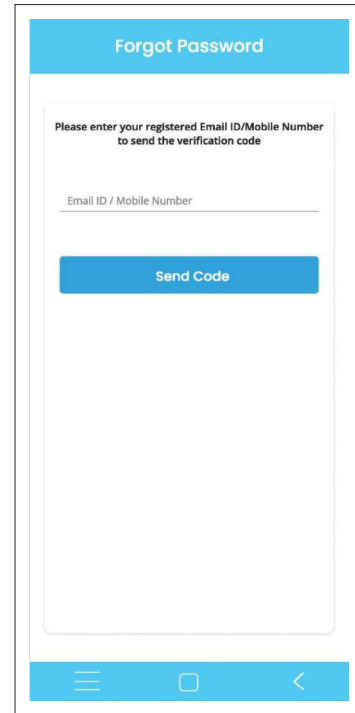

- Now, Enter the registered Email ID/ Mobile Number to receive the OTP.

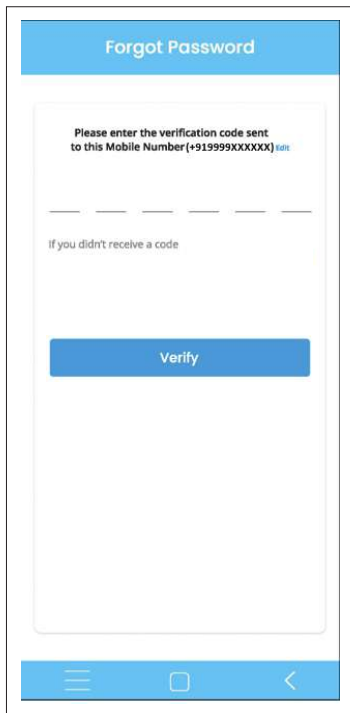

- App will automatically detect the OTP or user can enter manually.

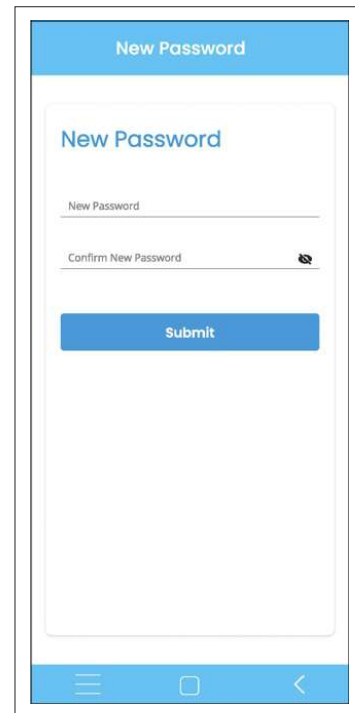

- Set the **New Password**.

# APP HOME PAGE

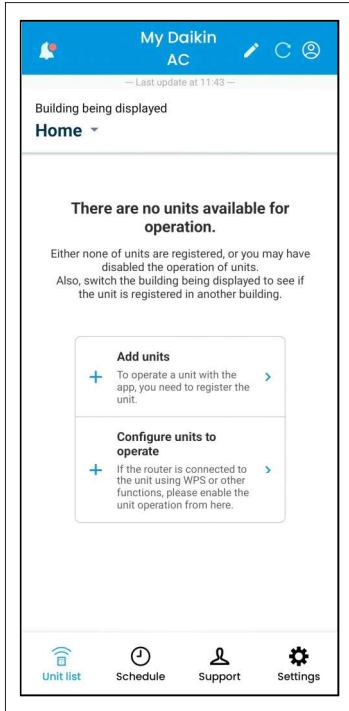

- This is the App Home Screen after login.

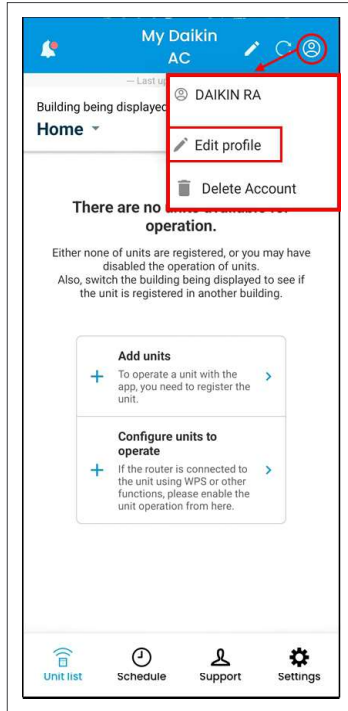

- User can view their Profile by tapping on top right corner of the screen.
- **Username and “Edit profile option”** are available.

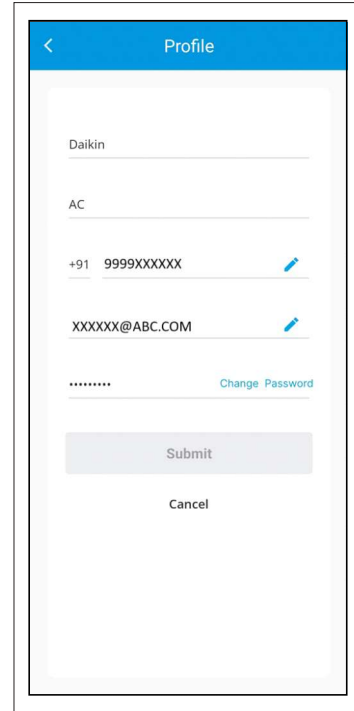

- To view Profile, tap “Edit Profile”.
- Username, registered mobile number and email are shown here.
- User can also change password here.

To Delete Account, follow the steps as mentioned below:-

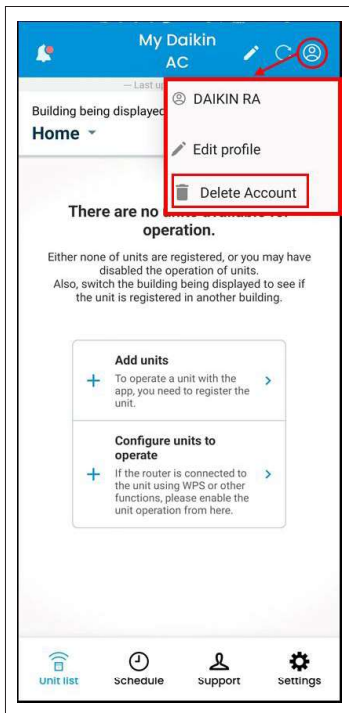

- On this screen, tap on “Delete Account”.

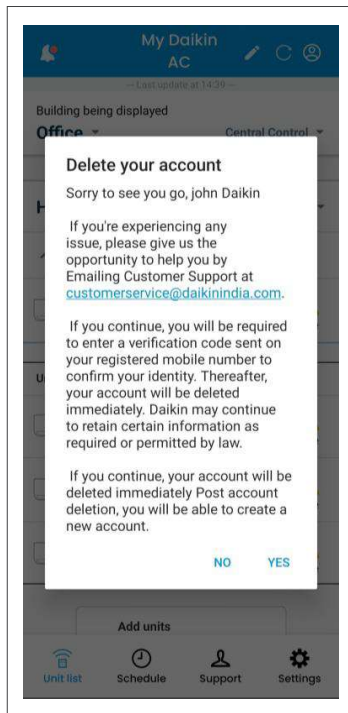

- Tap “YES” to give confirmation to delete the account.

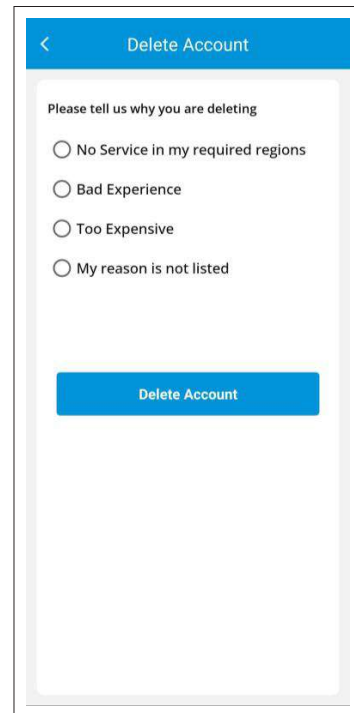

- Select any mentioned point and Tap on “Delete Account”.

# PROCESS FOR EDITING PROFILE DETAILS

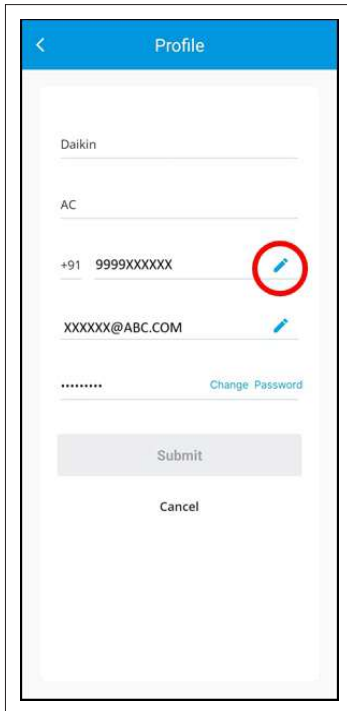

## Change Mobile Number

- User can change their registered mobile number by using edit icon as shown.

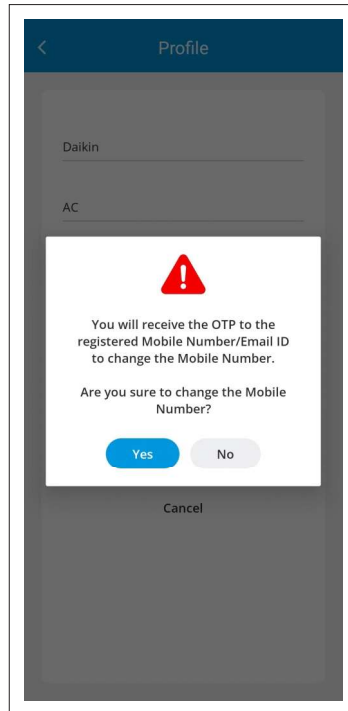

- OTP will be sent to the registered Mobile Number and Email.
- User need to select "Yes" to proceed.

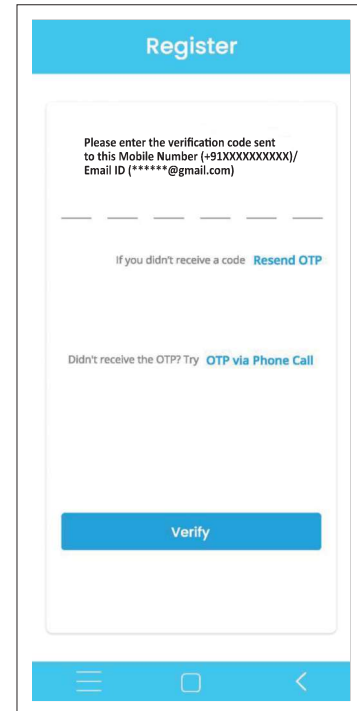

- Enter the received OTP on this screen and tap on "Verify".

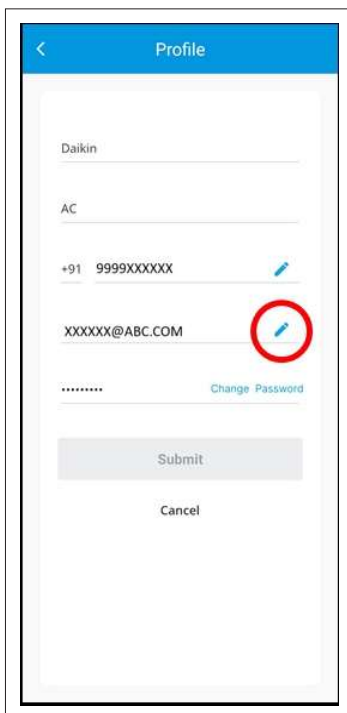

## Change Email-ID.

- User can change their registered Email ID by using edit icon as shown.
- Note:**
- The first name & last name can also be edited from the profile page.

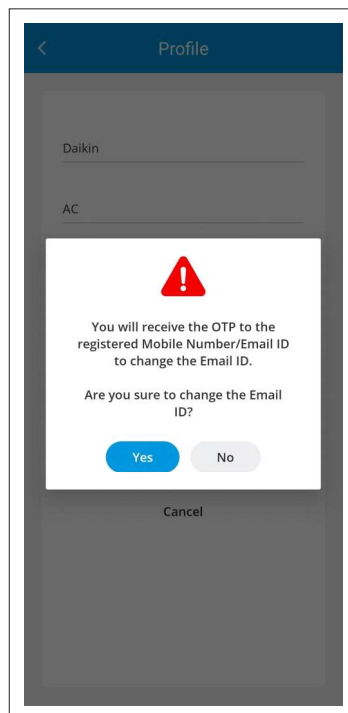

- OTP will be sent to the registered Mobile Number and Email.
- User need to select "Yes" to proceed.

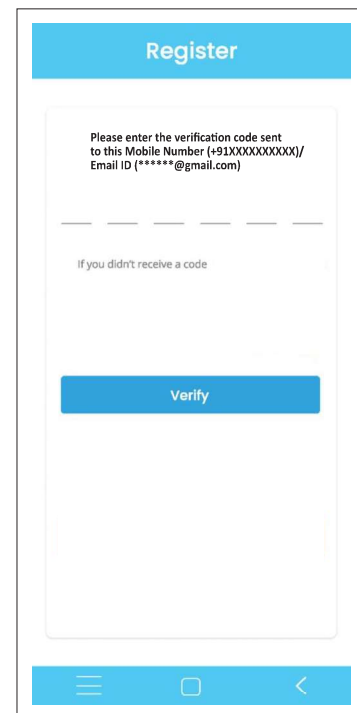

- Enter the received OTP on this screen and tap on "Verify".

# PROCESS FOR EDITING PROFILE DETAILS

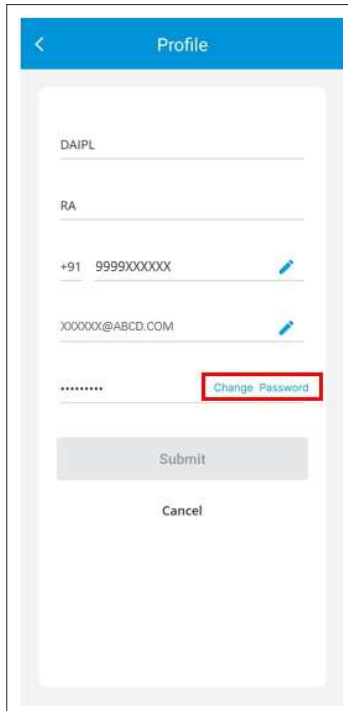

## Change Password

- To change your login password, Tap on **“Change Password”** on profile page as shown.

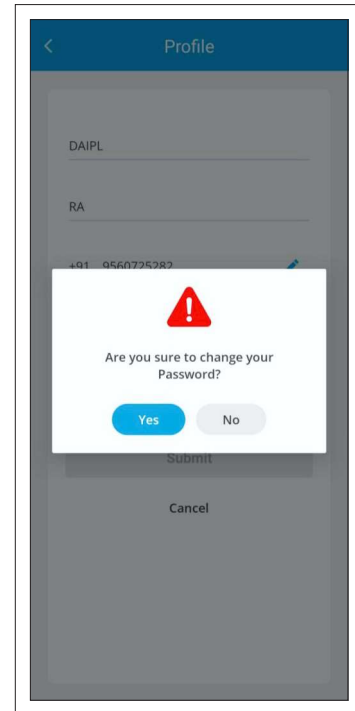

- Tap on **“Yes”** to confirm.

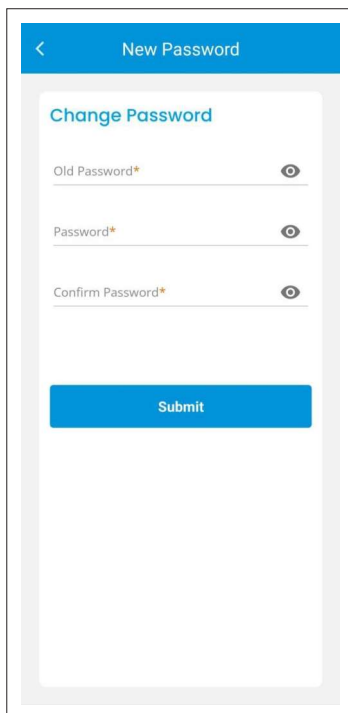

- Enter your old password and new password on this screen. Then tap on 'Submit' to proceed.

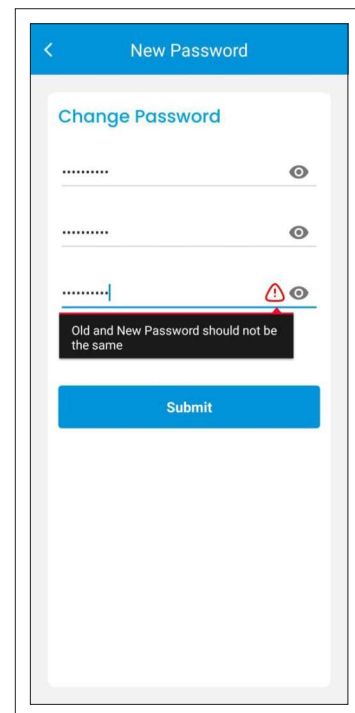

- Old and New Password should not be the same.

# PROCESS FOR EDITING THE BUILDING NAME and ROOM NAME

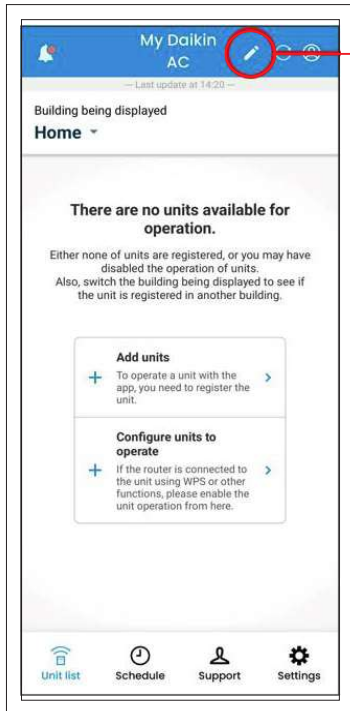

**Initial Home screen**

- Tap on edit icon on home screen as shown above to view and edit the unit list.

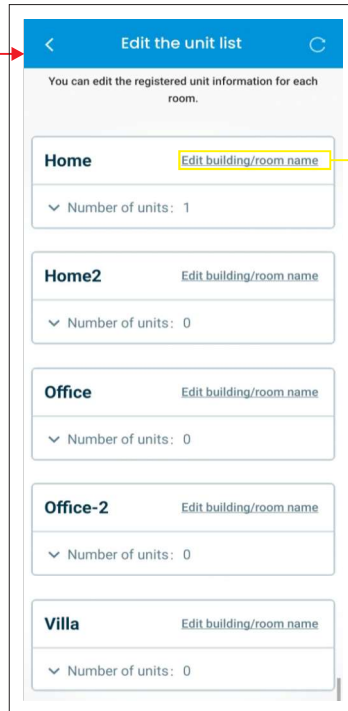

- On this screen, user can view registered number of units for each room.
- User can also edit building/room name here as shown.



- User can now edit Building Name and Room Name.

**Note:**

- Type the building or room name directly instead of copying and pasting it from another file, such as text. If you copy and paste a large amount of text into the input box, you may not be able to paste it correctly.



# PROCESS FOR REGISTERING UNIT TO A ROOM OF A BUILDING

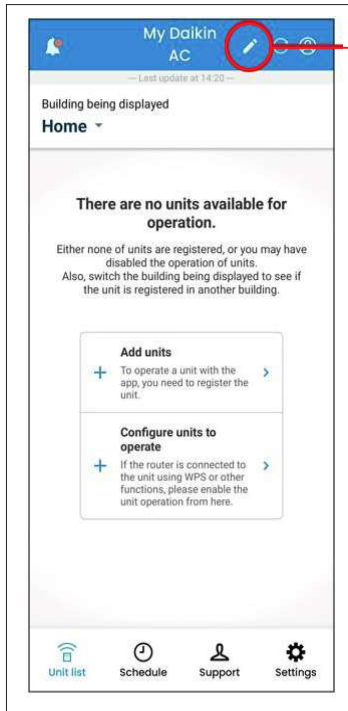

**Initial Home screen**

- Tap on edit icon on home screen as shown above to view and edit the unit list.

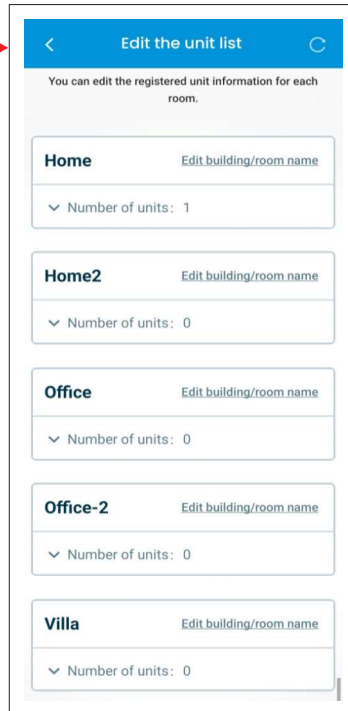

- On this screen, scroll down to view Unit with unconfigured room.

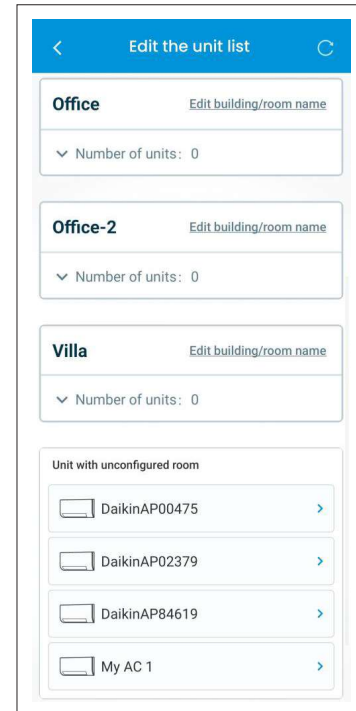

- Select the unit you want to register in the “Unit with unconfigured room” section

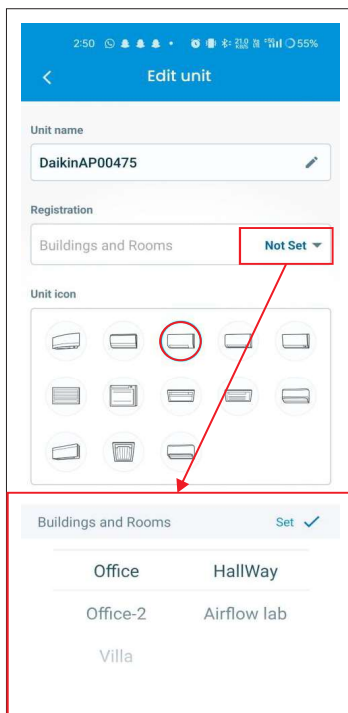

- Tap on “Not Set” as shown and select the Building and Room to which you want to add the unit. Then Tap on Set.
- User can also set Unit name.

**Note:**

- Up to 10 devices can be registered in one room.

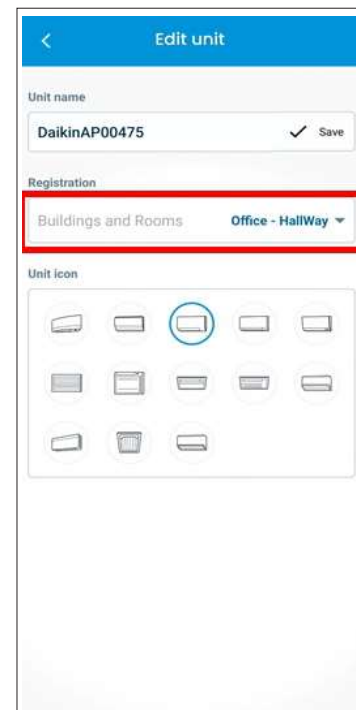

- Now, you can see the selected Building and Room.

# PROCESS TO ADD AIR CONDITIONING UNIT IN THE APP (ADD UNIT PROCESS)



- Tap on 'Add units' icon on homepage to add one or more units in the App.
- Note :**
- The Daikin air conditioner is here by referred to as unit .

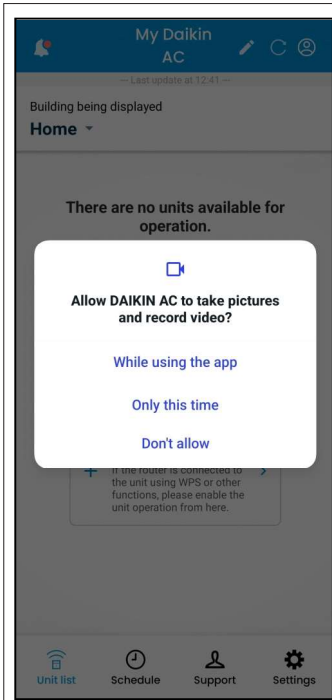

- On this screen, provide permission to take pictures and record video which is required to scan the QR code.

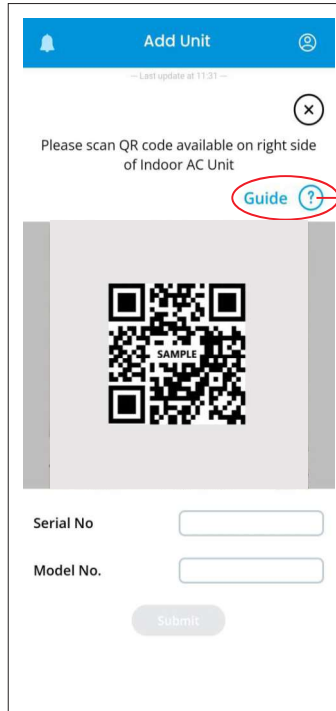

- Scan the QR code available on right side of indoor AC unit or enter Serial Number and Model Number of your Daikin AC unit to add to your Account.
- If you need help, tap on "Guide".



- Guide to Add your Daikin AC unit to your Account. Read carefully.
- Consult with your local authorized service person/dealer

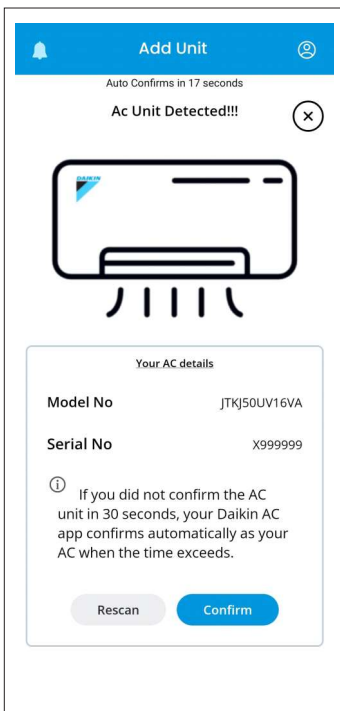

- Press confirm button to add your unit or it will confirm automatically in 30 seconds.

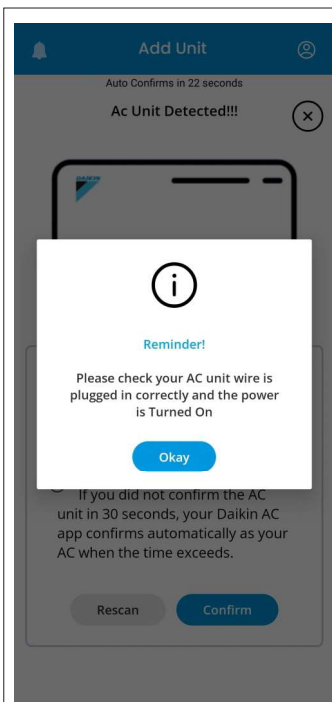

- Read this message and tap on "Okay" to proceed.

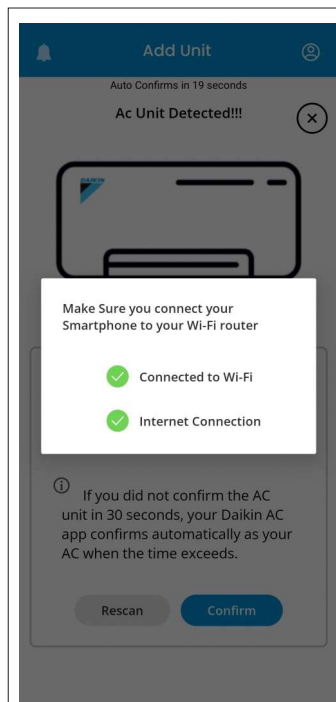

- This screen indicates that your Smartphone is connected to Wi-Fi and has internet connection.

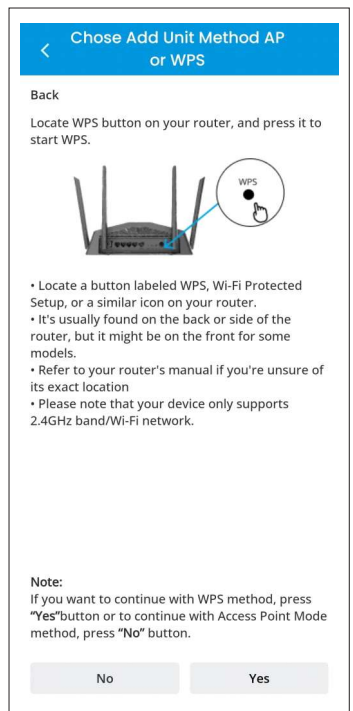

- To continue with WPS method, Tap "Yes" or to continue with AP mode method, Tap "No" on screen.

**Note:-** Users are requested to disable "Wi-Fi Assistant" or "Auto-switch to mobile network" in phone settings during Add a unit process.

# PROCESS TO ADD AC UNIT IN THE MOBILE APP USING ACCESS POINT (AP) MODE METHOD

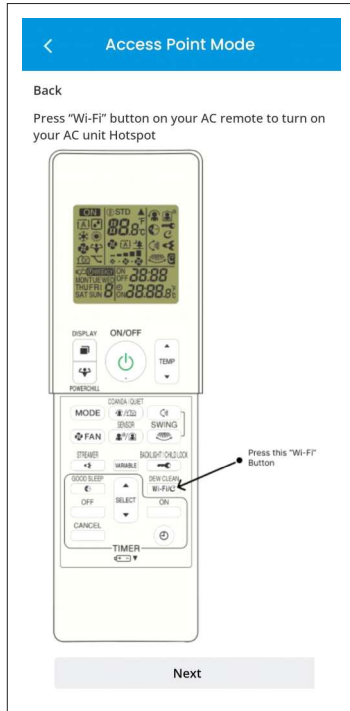

- Turn OFF unit from the remote controller (unit must be ON from main power supply.)
- Press “Wi-Fi” key for about 5 seconds on the remote and select "SP-1". (Refer Wi-Fi function details in unit operation manual).
- Tap 'Next' to proceed to the next step.

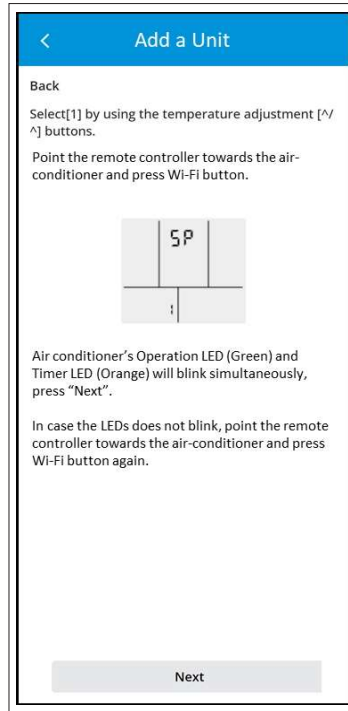

- Read on-screen instructions and tap Next.



- Connect the Smartphone and AC unit. Read the instructions

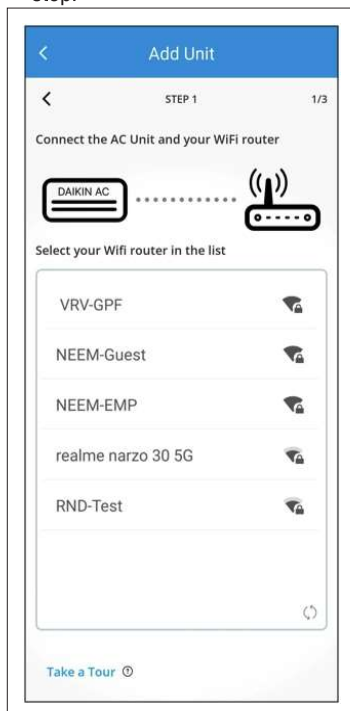

- Select your Wi-Fi router on this screen.

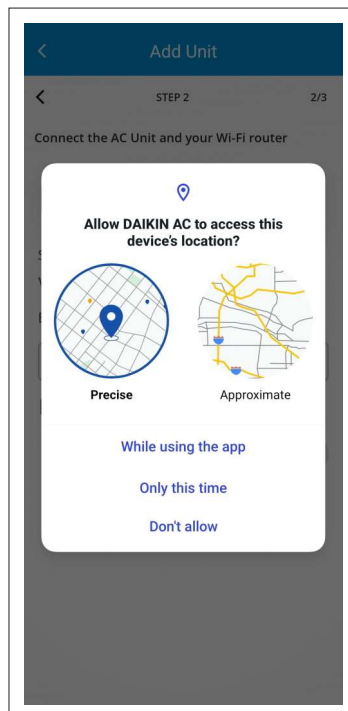

- User need to provide location access to proceed.

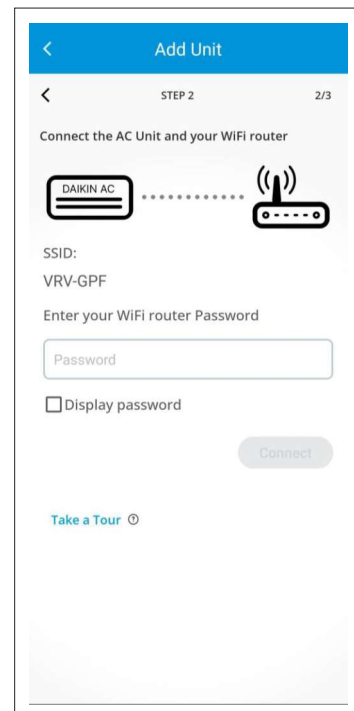

- Enter your Wi-Fi router password here and Tap “Connect”.

# PROCESS TO ADD AC UNIT IN THE MOBILE APP USING ACCESS POINT (AP) MODE METHOD

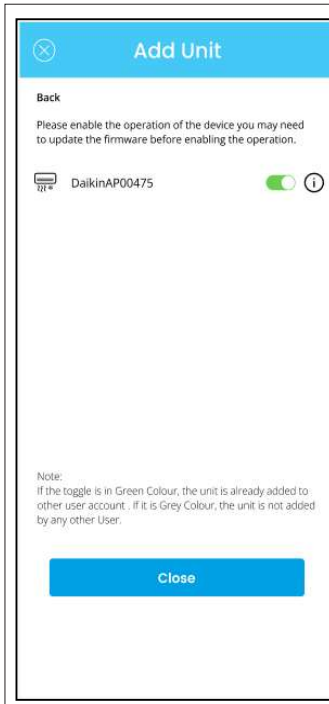
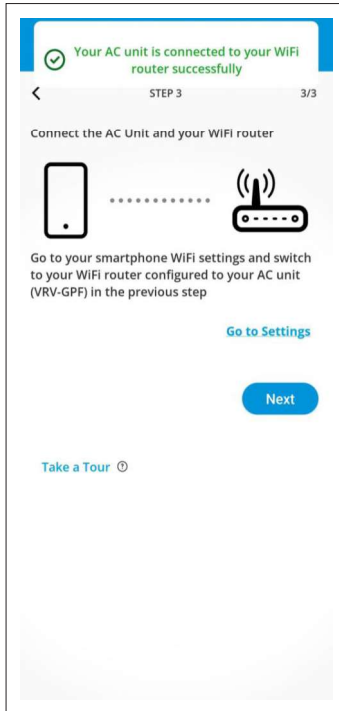

- Now Air Conditioner unit is successfully connected with home router.
- User need to connect smartphone with home router to operate the unit.
- Tap 'Next' to proceed to the next step.

- Please ensure that the toggle button is turned ON to operate the unit.
- If firmware update is required then App will update the firmware.
- Tap on 'Close' to redirect to the Unit list section in App.

- If this icon is shown next to unit name, Tap on it to update the firmware of the AC Wi-Fi.

# PROCESS TO ADD AC UNIT IN THE MOBILE APP USING WPS/SIMPLE CONNECTION METHOD

- Please ensure to follow these steps carefully to successfully add your AC unit to the Mobile App using the WPS method.

## Step 1:

- Ensure the AC unit is turned off
- Using the remote, give the command "SP 2."
- The Operation LED and Timer will blink simultaneously.

## Step 2:

- Locate the WPS button on your home router.
- Press the WPS button on the router.
- Only the Timer LED on the AC unit will blink once a connection between the AC unit and the home router is established.

## Step 3:

- Connect your Mobile to the Home Router Wi-Fi.
- Open the Mobile App on your smartphone.
- Navigate to the "Add units" on Homescreen and follow the instructions

## Step 4:

- Look for the SSID of the Wi-Fi module displayed on the screen. The SSID will start with "DAIKINAP?"
- Toggle the button next to the SSID to enable it. This action adds the unit to the Mobile App.

## Step 5:

- Tap on the close button located in the top left corner of the screen to exit the configuration process.

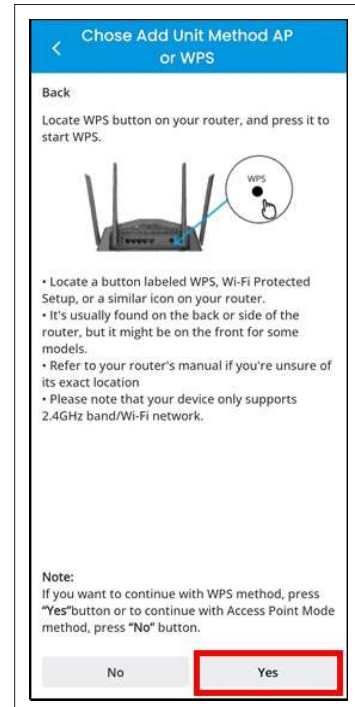

- To continue with WPS method, tap "Yes" on screen.

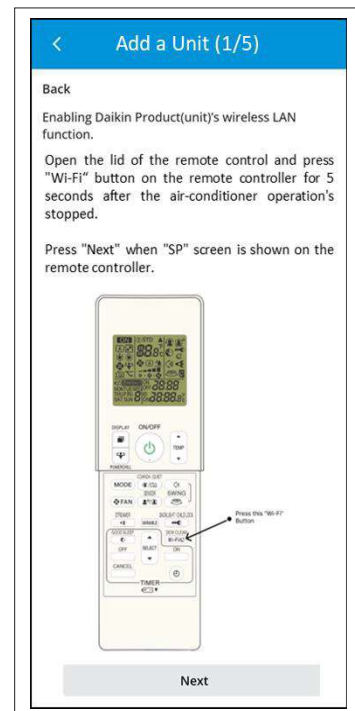

- Tap "Next" to proceed.

# PROCESS TO ADD AC UNIT IN THE MOBILE APP USING WPS/SIMPLE CONNECTION METHOD

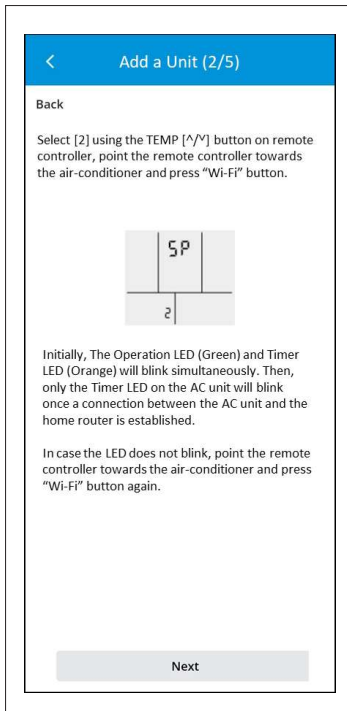

Press Next

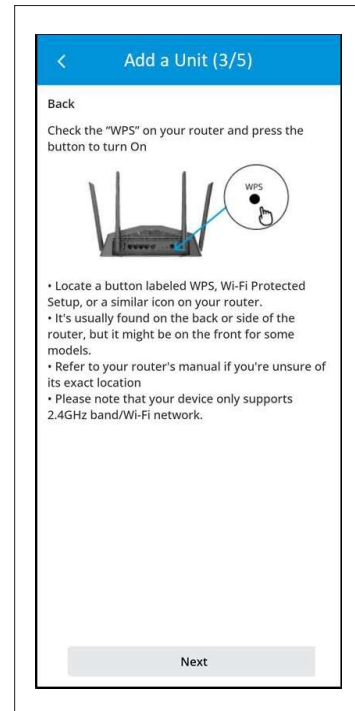

Press Next

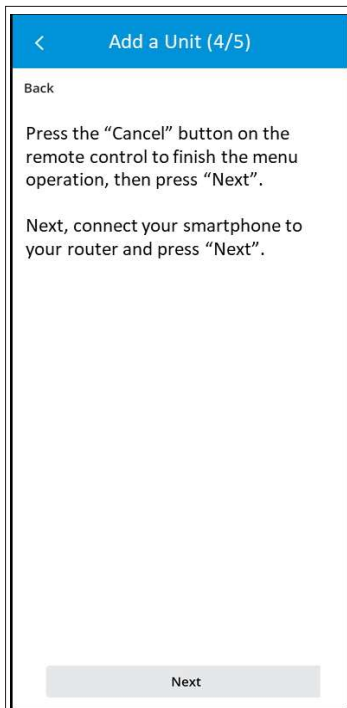

Press Next



Press Next



• Select your unit and then close.



# PROCESS TO UPDATE FIRMWARE OF AC WI-FI



- Tap on firmware update button right next to the unit name to update the firmware of AC Wi-Fi.



- Current version and Latest version details are shown on this screen. Tap on Update button to proceed.

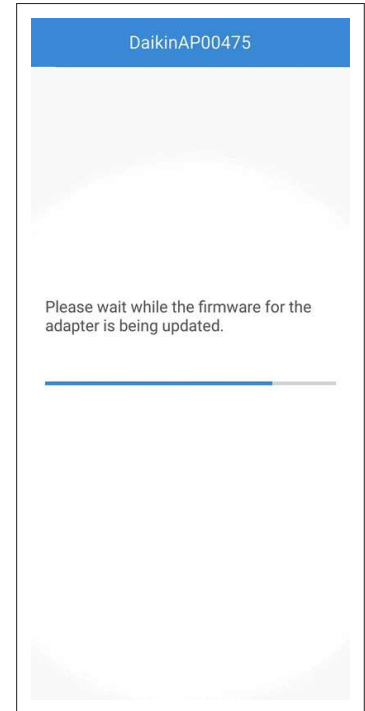

- This screen represents the firmware update progress.

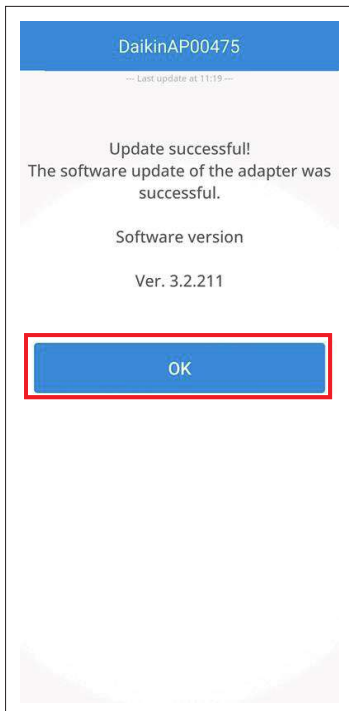

- This screen represents the firmware update successful. Tap on OK button to proceed.

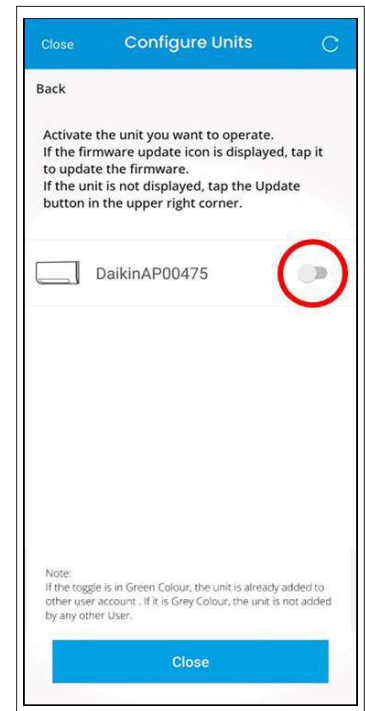

- Now, Turn ON the toggle button.



# HOME PAGE - HOW TO START A UNIT

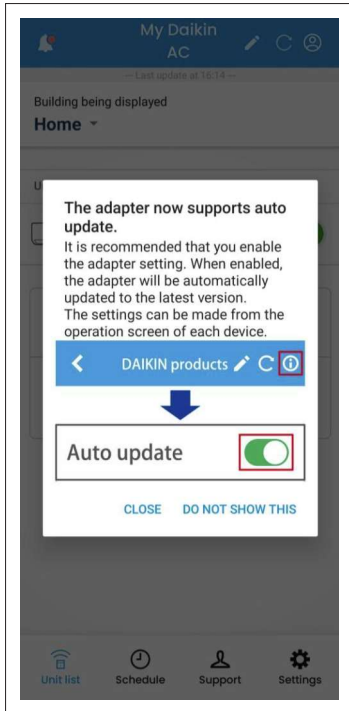

- Read this message and tap on 'Close' to proceed.

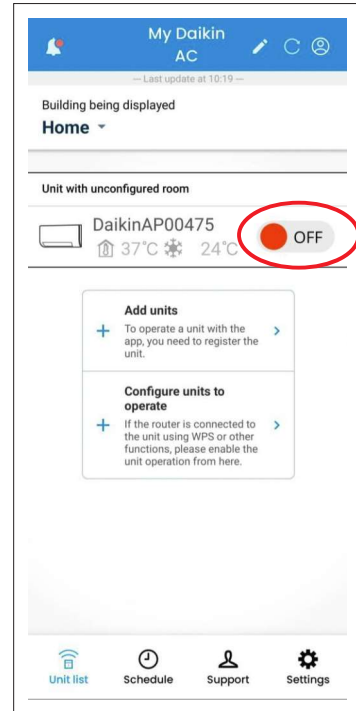

- This represents AC unit is OFF. To Turn ON the AC, tap on the toggle button present next to the Unit name.

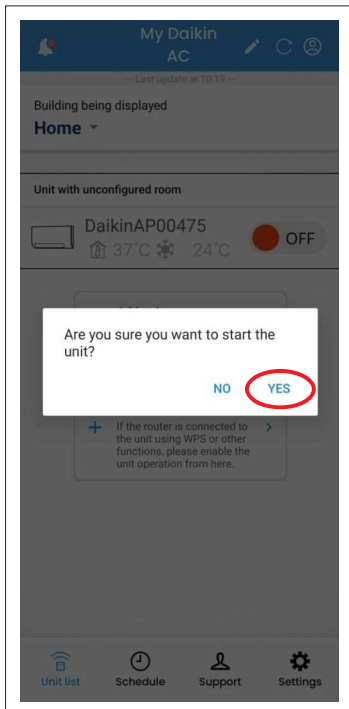

- Tap 'Yes' to confirm and turn ON the AC unit.

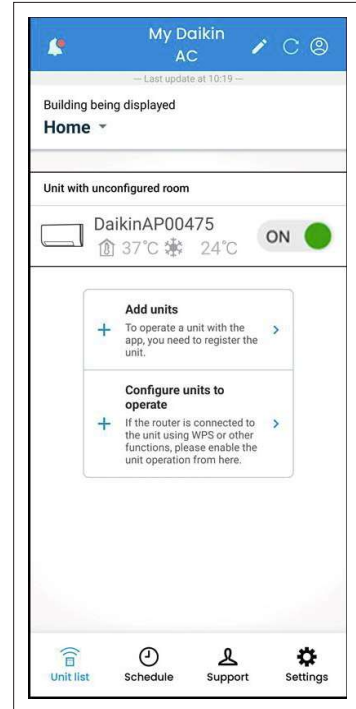

- AC Unit is turned ON as shown in the picture.

# HOME PAGE - HOW TO START A UNIT

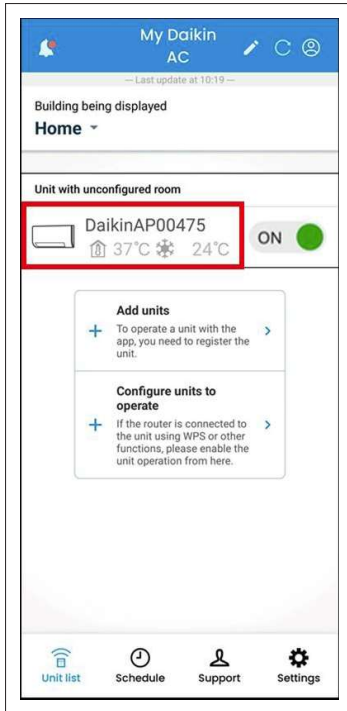

- Tap on AC Unit name as shown above to operate the AC by mobile application.

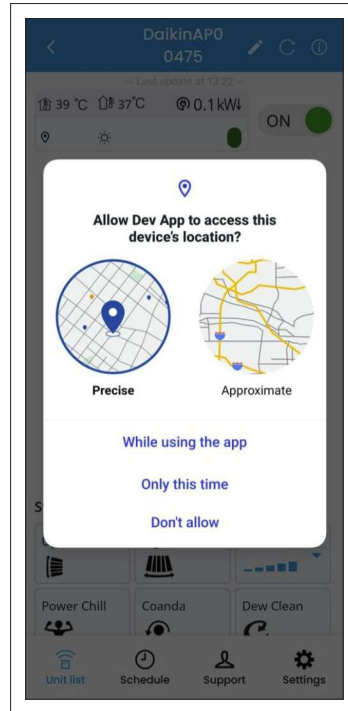

- User need to provide location access to mobile app.



- On opening the AC unit, this screen will appear.

# HOME PAGE AFTER MULTIPLE UNITS ARE ADDED

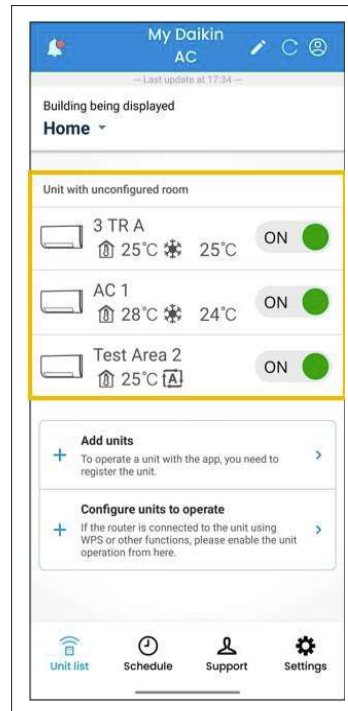

- User can add multiple air conditioner units in the App.
- Currently these units are not configured to any room and building. User need to assign the added units to a building and room.

# CENTRAL CONTROL

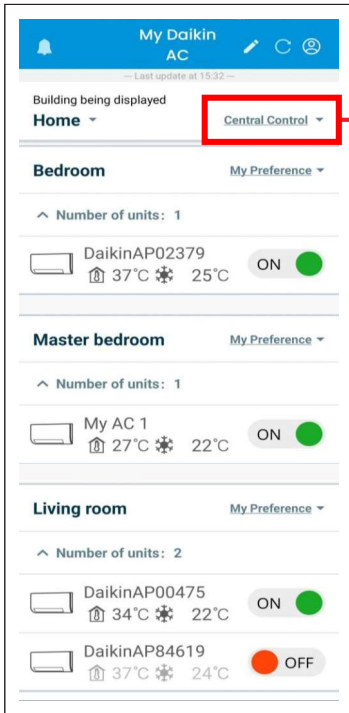

Homescreen after units are added in Building and Room.

1. Select Central Control to operate all registered units in the building.
2. User can disable all units registered to a building and rooms.

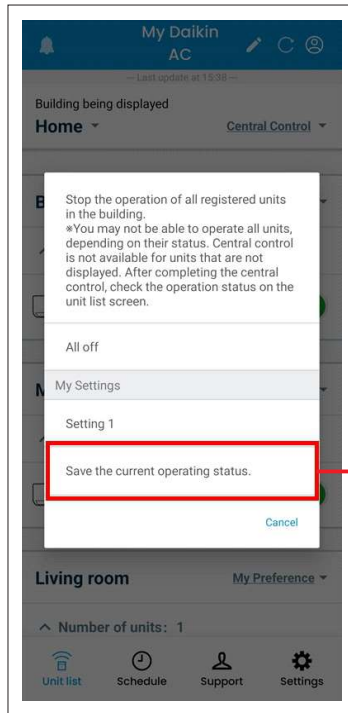

- Tap on **"All off"** to stop the operation of all registered units in the building.
- User can select **"Save the current operating status"** in My Settings to save the current settings of all registered units in the building.

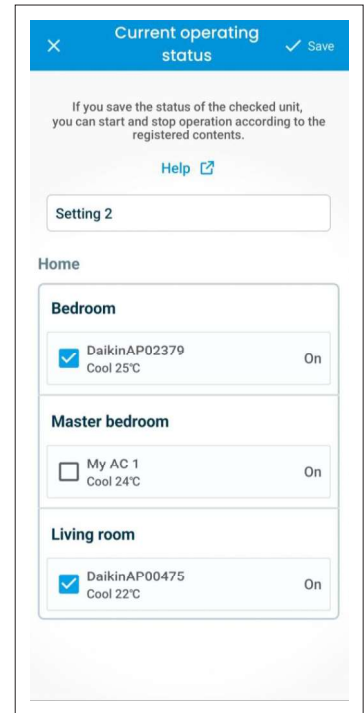

- Select the units you want to operate through central control, Enter Name of the setting and Save it (up to 14 characters).

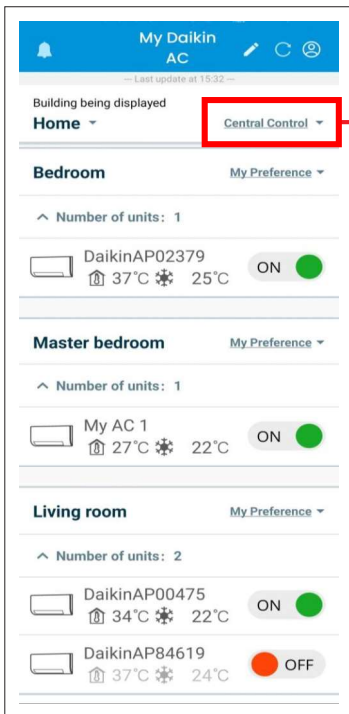

Homescreen after units are added in Building and Room.

- Select Central Control to operate all registered units in the building.
- User can disable all units registered in the building.

**Notes:** The equipment in all rooms stops. Do not use if there are people in the room who are unable to control the temperature by themselves, such as infants, people with disabilities, and the elderly.

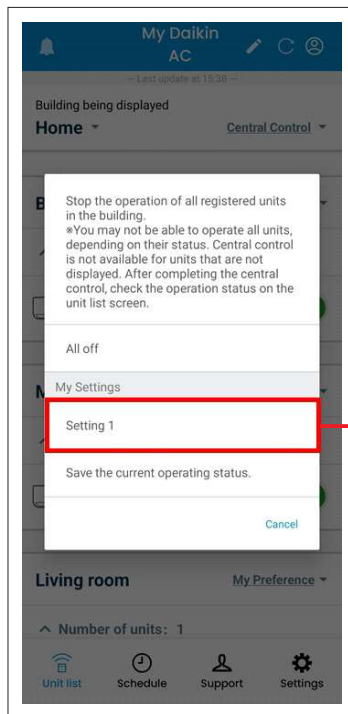

- You can select already saved setting (Setting 1) as shown or "Save the current operating status" of all registered units in the building in **"My Settings"**.

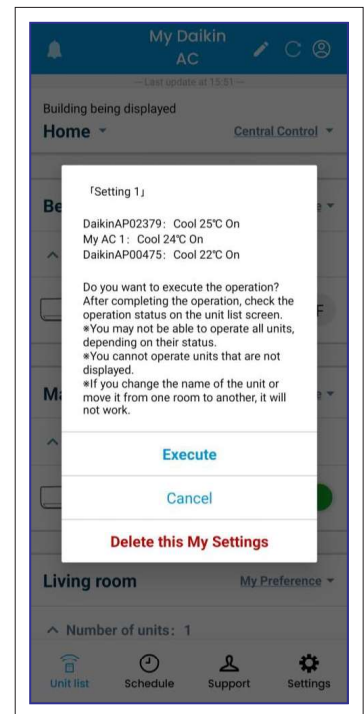

- Read the disclaimer carefully and Tap on **"Execute"** to confirm.
- To delete the setting, tap on **"Delete this My Settings"**

# MY PREFERENCE

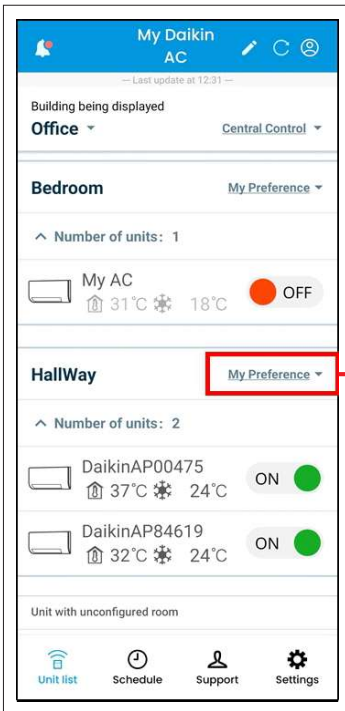

## Homepage after units are added in Building and Room.

- Select My Preference to control multiple units in each room at once.

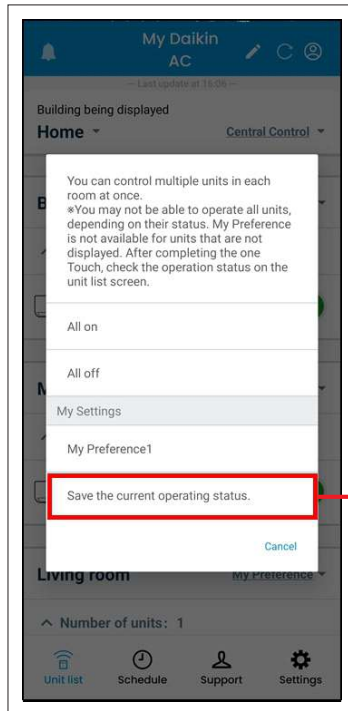

- Tap on All on/All off to start/stop the operation of all registered units in each room at once.
- You can also Save the current operating status of all registered units in each room at once.

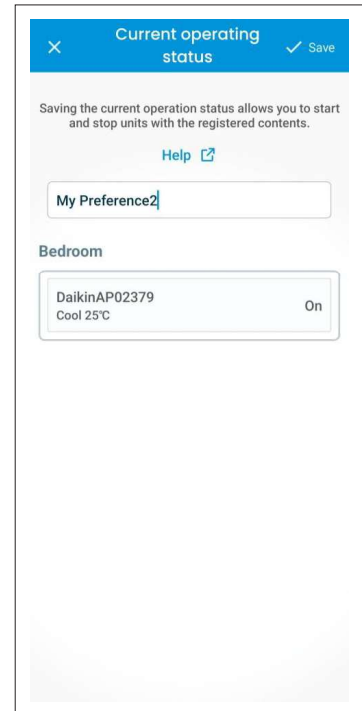

- Enter the name of the setting and Save it (up to 14 characters).

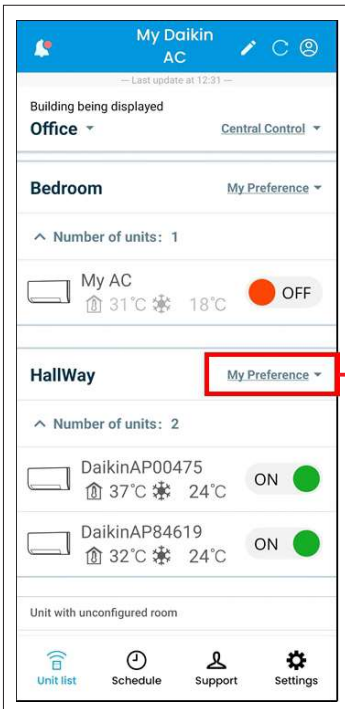

## Homepage after units are added in Building and Room.

- Select My Preference to control multiple units in each room at once

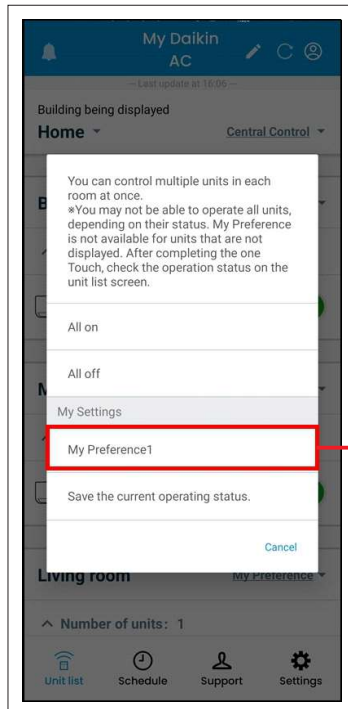

- Tap on All on/All off to start/stop the operation of all registered units in each room at once.
- You can also select already saved "My preference1" to operate all the registered units in room.

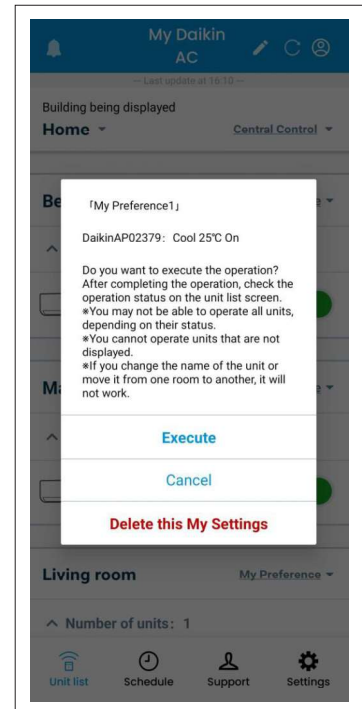

- Tap on "Execute" to confirm.
- To delete the setting, tap on "Delete this My Settings"

### Notes:

- By saving the desired operating status, the units registered in the room can be started and stopped with the desired settings.
- The My Preference function is not subject to the My Preference operation when "moving a building/room" or "changing the name of a device". Please re-save My Preferences.

# PROCESS TO CONFIGURE UNIT

To configure one or more number of units that are connected to a Wi-Fi Router. First, You need to connect your smartphone to that Wi-Fi Router

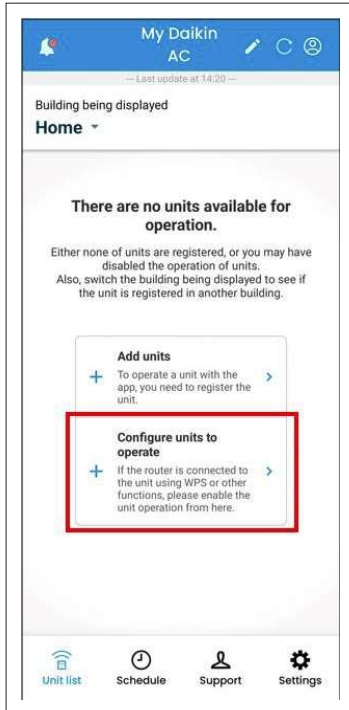

- Tap on “**Configure units to operate**” on Homescreen.

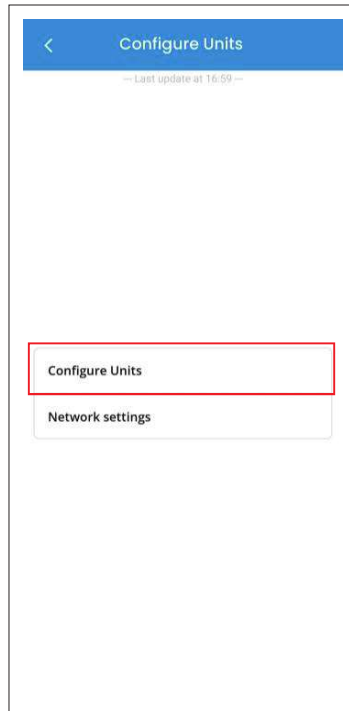

- Tap on “**Configure Units**” on this screen.

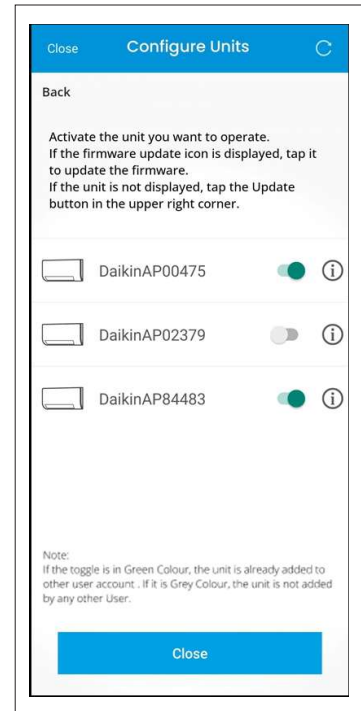

## Multiple units

- After adding multiple units, user can choose to activate or deactivate the registered units.
- Tap on “**Close**” to redirect to Homescreen

# PROCESS TO CHANGE HOME ROUTER NETWORK

- If user wants to change home router then user can do this with the help of “Configure units to operate” icon.
- First, connect your smartphone to the AC Wi-Fi hotspot starting with 'DaikinAP'.

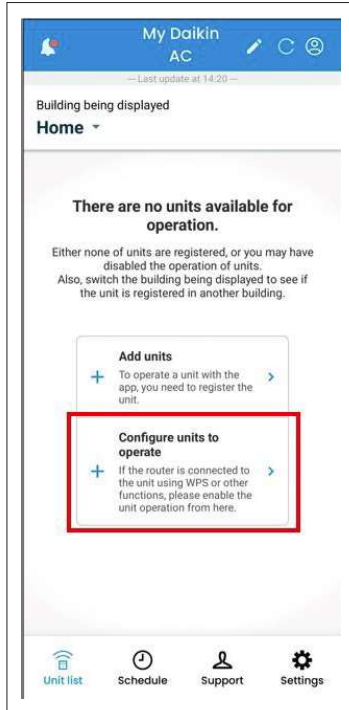

## STEP 1

- Tap on “**Configure units to operate**” on Homescreen..

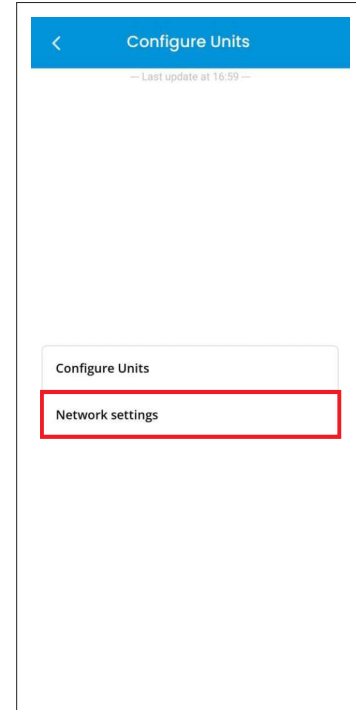

## STEP 2

- Tap on “**Network settings**” on Homescreen.

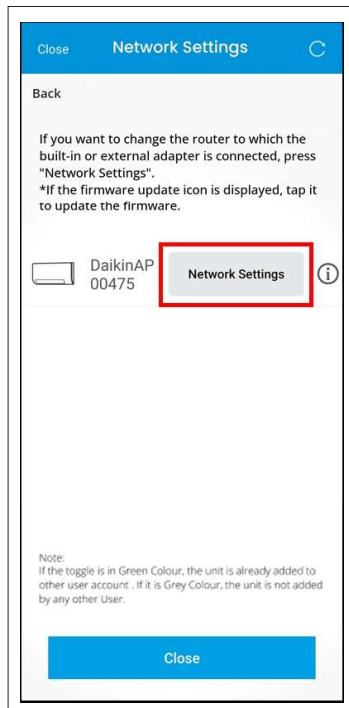

## STEP 3

- Tap on “**Network Settings**” to change the router to which adapter is connected.

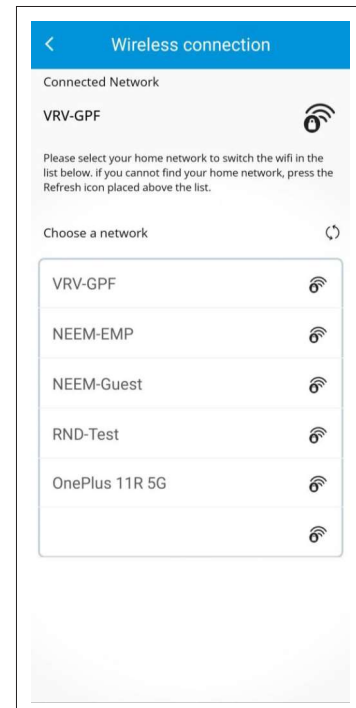

## STEP 4

- Select the network of the new router to which you want to connect the adapter.



# PROCESS TO CHANGE HOME ROUTER NETWORK

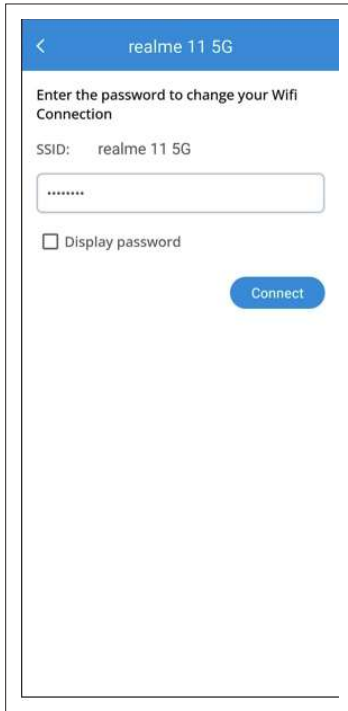

## STEP 5

- Enter the **password** of the router network and tap on Connect.

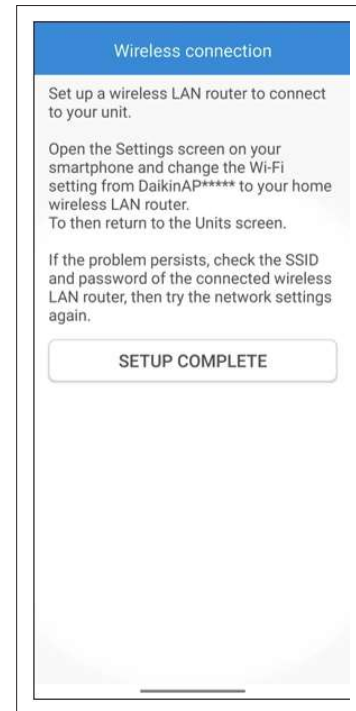

## STEP 6

- Tap on "**SETUP COMPLETE**" to complete the process.

# HOME SCREEN DETAILS

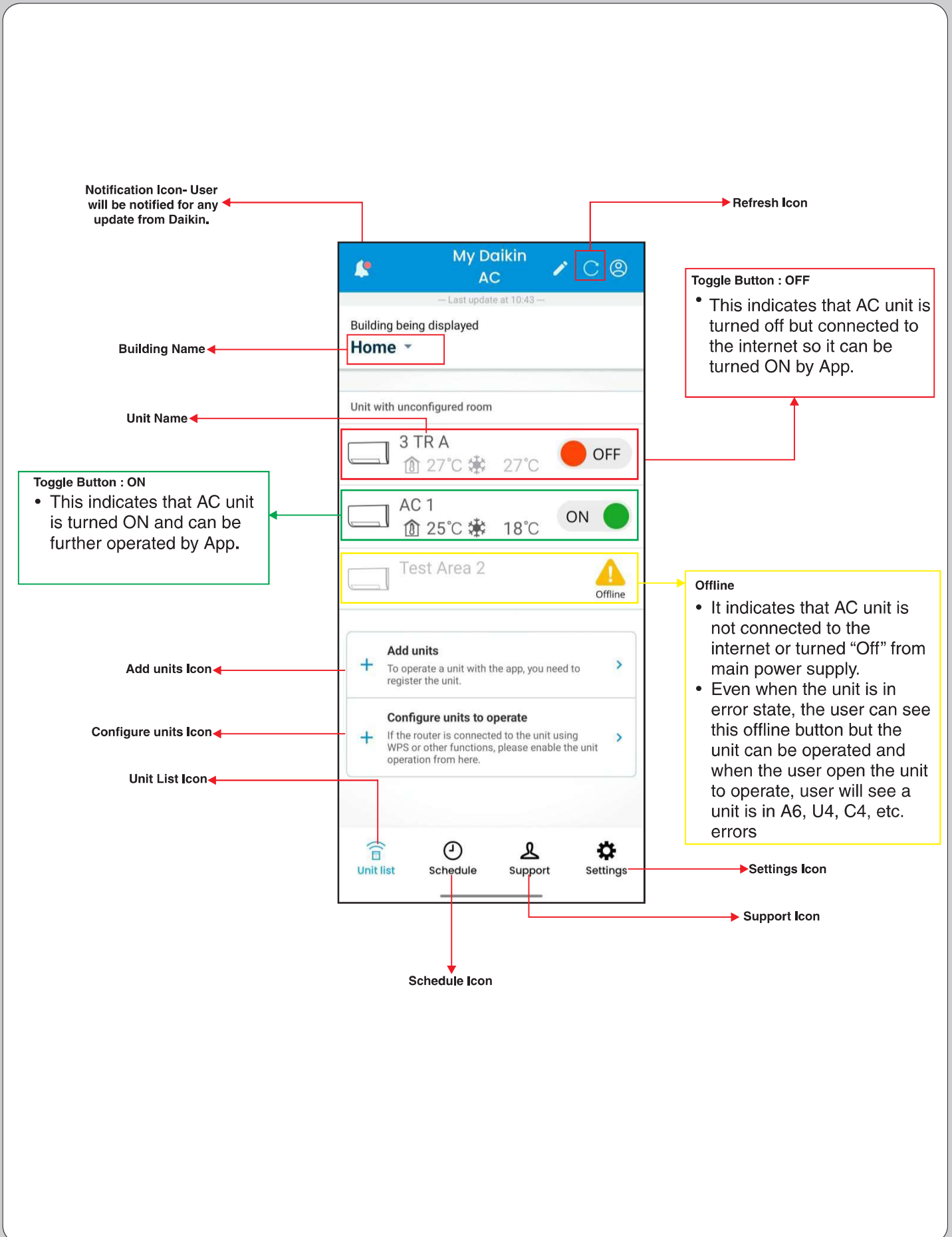

# HOW TO USE CONTROL SCREEN

The screenshot shows the DaikinAP control interface. At the top, it displays room and outdoor temperatures (37°C), power consumption (0.100kW), and a power status (OFF). Below this, it shows the location (Hyderabad), weather (Clear sky), and AQI (60). The main control is a circular dial set to 24°C in Cooling mode. A 'Next Scheduled Action' section shows a Monday 07:00 schedule at 23°C. The 'Operation Mode' section allows switching between modes. 'Standard Features' include swing, airflow rate, powerchill, coanda, and dew clean. 'Advanced Features' include streamer, intelligent eye, variable, outdoor quiet, and consumption. A bottom navigation bar includes Unit list, Schedule, Support, and Settings.

- First row displays Room Temperature, Outdoor Temperature, Instantaneous Power Consumption.
- Second row displays Location of machine where it is installed for first time, Weather and AQI at that particular location.

**Toggle button:**

- Turn ON/OFF the unit.

- Displays the set temperature and mode of operation. Not only the - & + sign the slider can also be used to **increase** and **decrease** the temperature .

- Displays the **Next Scheduled Action** showing day, time of schedule, Operation Mode, Set Temperature and Fan Speed.

- Tap to select Operation Mode i.e. **Dry - Cool - FAN** (Heat and Auto Mode would be available in Choidan and heat & Cold Models).

- Set of **Standard Features** including Up & Down Swing, Right & Left Swing, Airflow Rate, Powerchill, Coanda and Dew Clean.

- Set of **Advanced Features** including Streamer, Intelligent Eye, Variable and Outdoor Quiet.

- User can check **weekly, monthly, yearly** electricity consumption.

**Note:**

- If user shift the air conditioner unit after sometime of usage than user need to again do the add unit process to update the new location.
- Instantaneous power consumption is reference or indicative value only, it can vary from actual values.
- AQI values are taken from third party API , it can have variations depending upon third party API's.
- Depending upon different models, standard features and advance features icon will appear on the screen.

# OPERATION MODE



- User need to click on **Operation Mode** to select different modes.

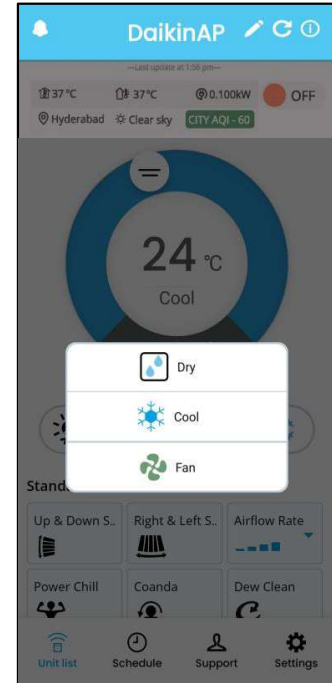

- User can select : **Dry, Cool and Fan mode** as per requirement.

## Note :

- Auto and Heat Modes would be available only in Choidan, Heat and Cold Models.
- Whenever unit is Turned ON through App, unit will follow below table.
- Whenever AC is switched OFF in dry mode and is switched ON from remote, air conditioner will start in Cool mode and then DRY mode selection can be done using the MODE button.

| Mode | Set temperature before Turn OFF by Mobile App. | Set temperature after Turn ON by Mobile App.                                  |
|------|--|---|
| COOL | If Set temperature < 24°C                      | Default set temperature will be 24°C  |
|      | If Set temperature >= 24°C                     | Default set temperature will remain same as set prior to remote switched OFF. |

# SWING - UP & DOWN SWING ; RIGHT & LEFT SWING



- User need to click on **Up & Down Swing** or **Right & Left Swing** or both swing together to turn it on.



- **Up & Down Swing** and **Right & Left Swing** will turn to blue in colour which indicates that swing is turn On. User can Turn ON 3D Swing by clicking Up & Down Swing and Right & Left Swing.

# How to use Airflow Rate and Power Chill feature



- User need to tap on **Airflow Rate icon** (as shown above).
- Note:**
- If Unit is Turned ON through Mobile App in Cool/Dry Mode and Auto Airflow rate, then smell proof operation will start

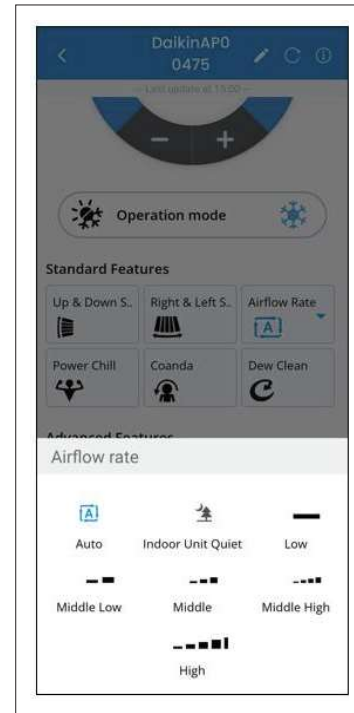

- User can choose from different fan speeds i.e., Indoor Unit Quiet, Low, Middle Low, Middle, Middle High, & High based upon your requirement.

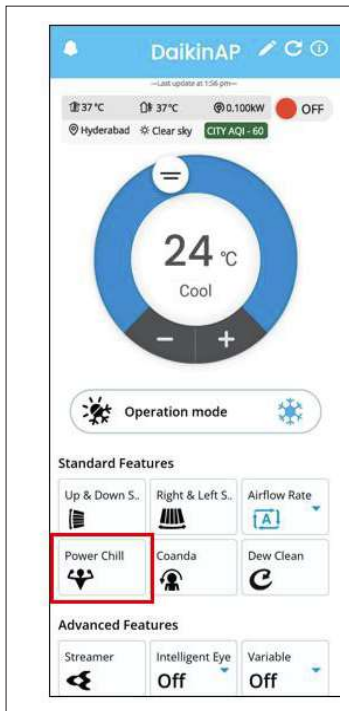

- To use Power Chill operation, user need to click on **Powerchill icon**.



- The Power Chill icon colour will change to **blue** (this indicates the feature is turned ON).
- Note:**
- When power chill is on user cannot operate temperature & fan speed.

# COANDA OPERATION

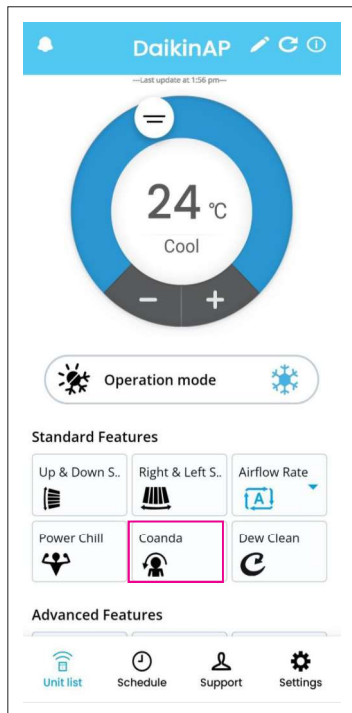

- User need to click on **Coanda** icon.

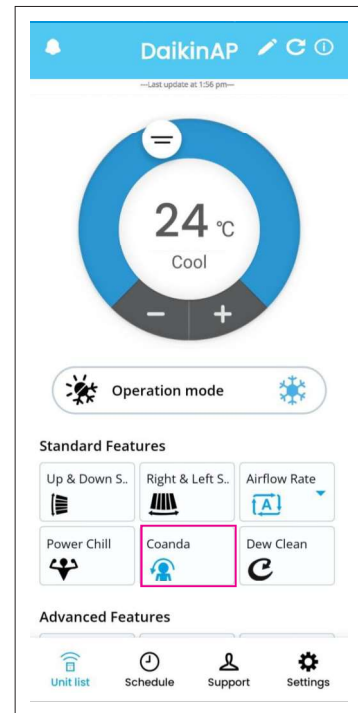

- After that Coanda icon will turn **blue**, this indicate Coanda operation is turned ON.



# DEW CLEAN OPERATION

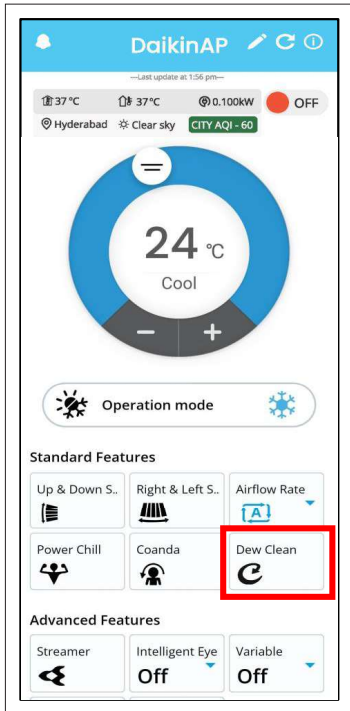

- User need to click on “Dew Clean” icon.

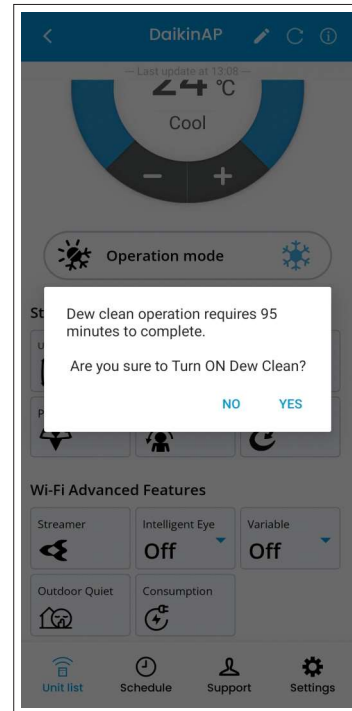

- App will again request permission to Turn ON the operation. After user confirm to Turn ON, then user need to follow the next step.

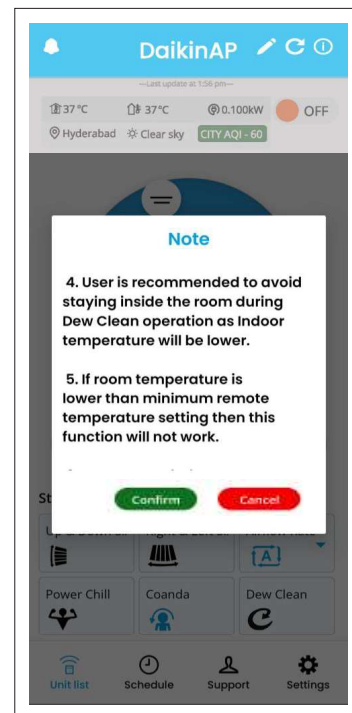
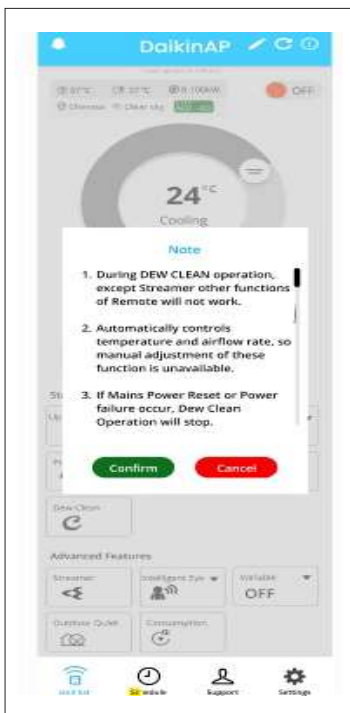

User is recommended to carefully read and follow the Notes.

# DEW CLEAN OPERATION

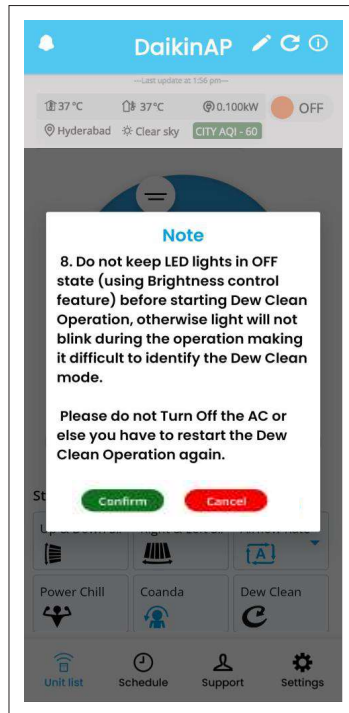
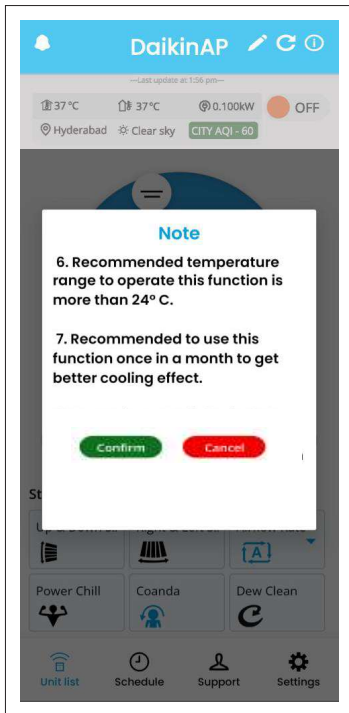

User is recommended to carefully read and follow the Notes.

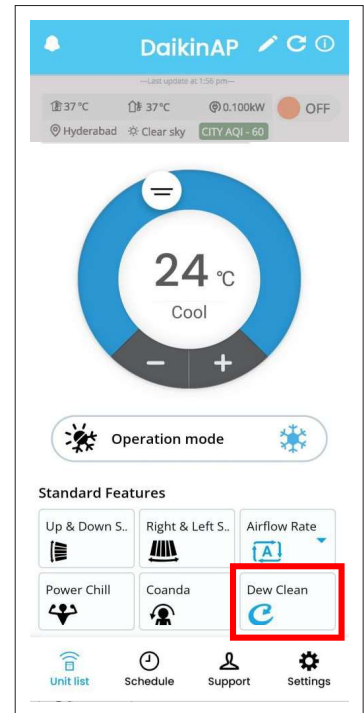

- After confirmation from user, Dew Clean Operation icon will turn **blue** (this indicates dew clean operation is Turned ON)

# STREAMER OPERATION

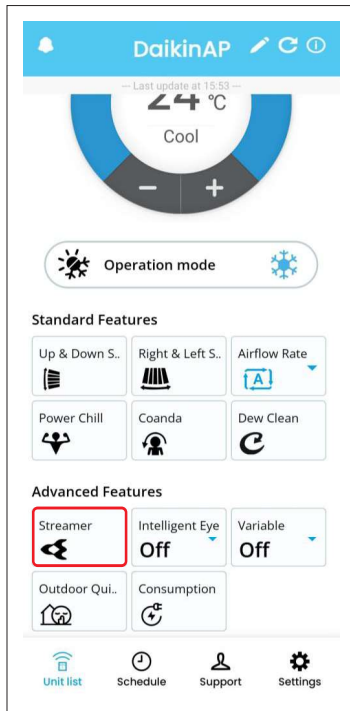

- User need to click on “**Streamer Icon**” (as shown above) to Turn ON and Turn OFF the operation.

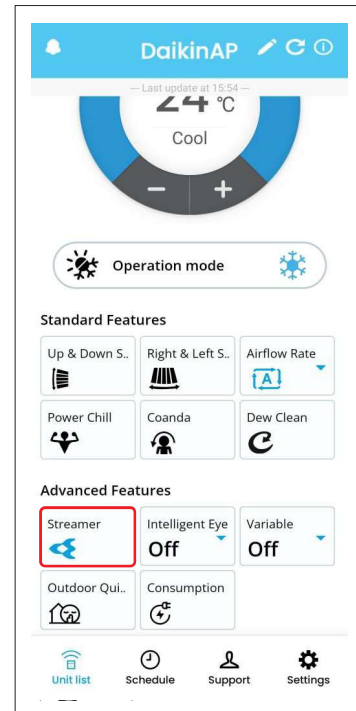

- When streamer icon will turn **blue**, it indicates the streamer operation is Turn ON.

# INTELLIGENT EYE OPERATION

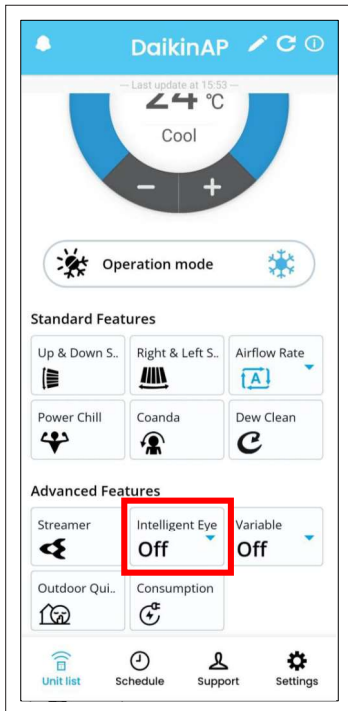

- User need to click on **Intelligent Eye** Icon (as shown above) to Turn ON the operation.

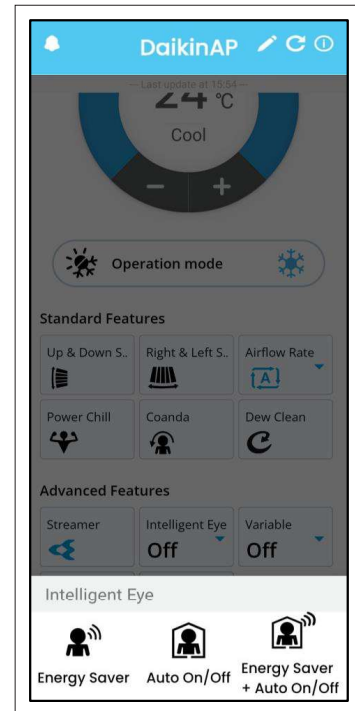

- User can select **Energy Saver** , **Auto ON/OFF** or combination of **Energy Saver** and **Auto ON/OFF** features.

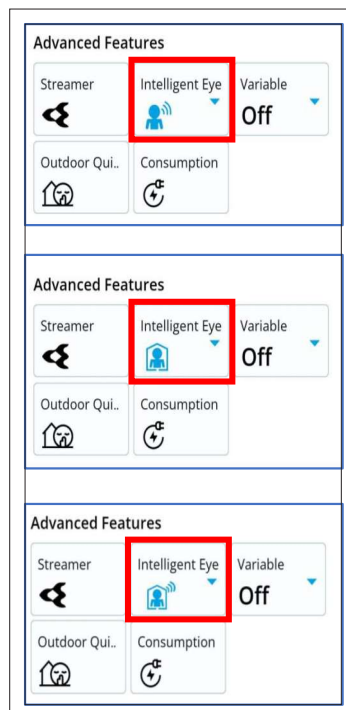

**Intelligent Eye: Energy Saver**

**Intelligent Eye: Auto ON/OFF**

**Intelligent Eye: Combination of Energy Saver & Auto ON/OFF.**

- When Intelligent Eye icon turns **blue**, it indicates the Intelligent Eye operation is Turn ON.

# VARIABLE OPERATION

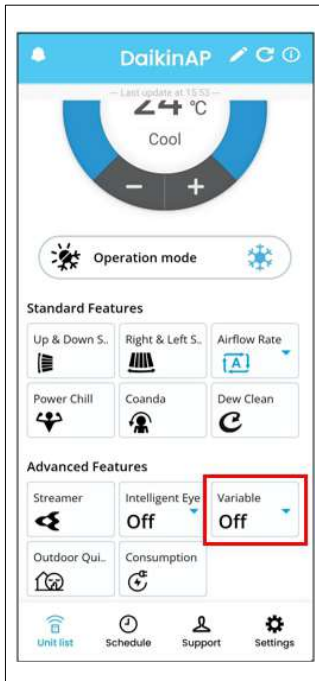

- User need to click on **Variable Icon** (as shown above) to Turn ON the operation.

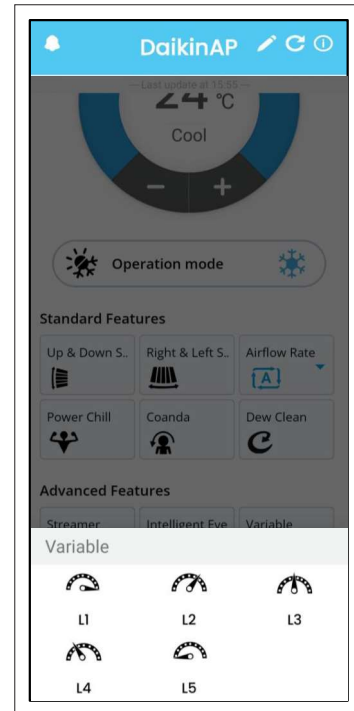

- User can select from **L1 to L5** based upon requirement.

**Note:-**

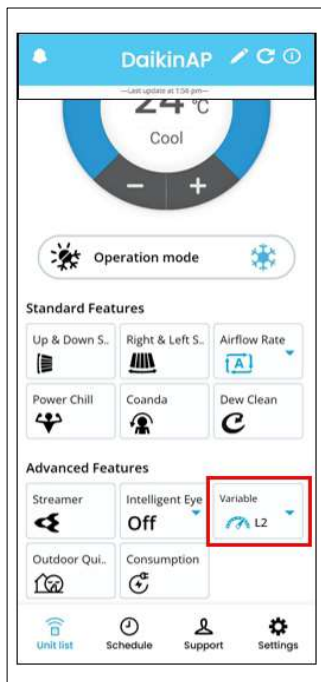

- In this screen, **Variable L2** is selected and Variable icon turn in **blue** colour.

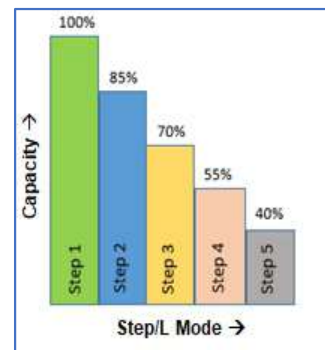

| Variable Step | Capacity |
|---------------|----------|
| L1            | 100%     |
| L2            | 85%      |
| L3            | 70%      |
| L4            | 55%      |
| L5            | 40%      |

# OUTDOOR QUIET OPERATION

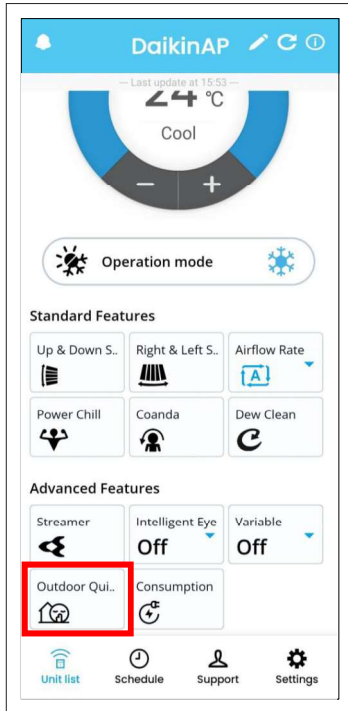

- User need to click on **Outdoor Quiet** Icon (as shown above) to Turn ON and Turn OFF the operation.

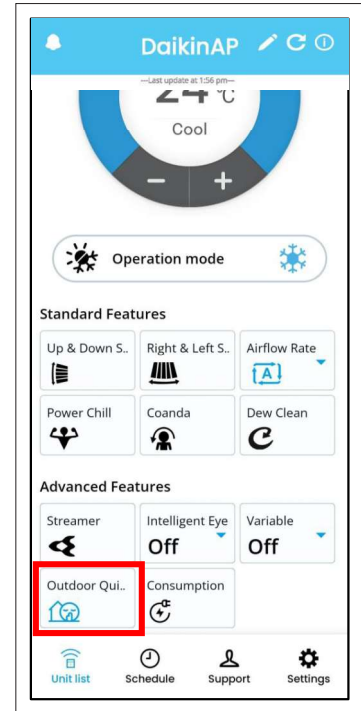

- When Outdoor Quiet operation is Turn ON, the icon colour will change to **blue**.

# ELECTRICITY CONSUMPTION FEATURE

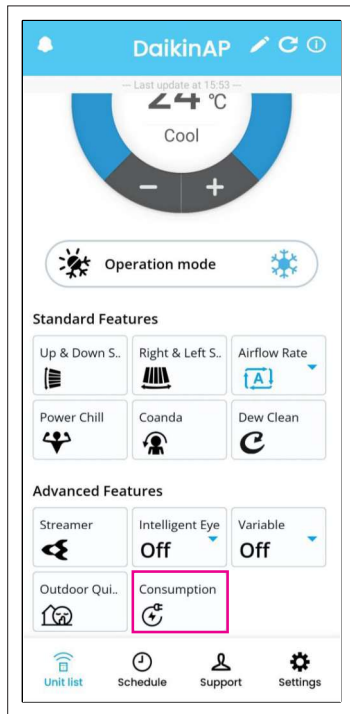

- User need to click on **Electricity Consumption** icon (as shown above).

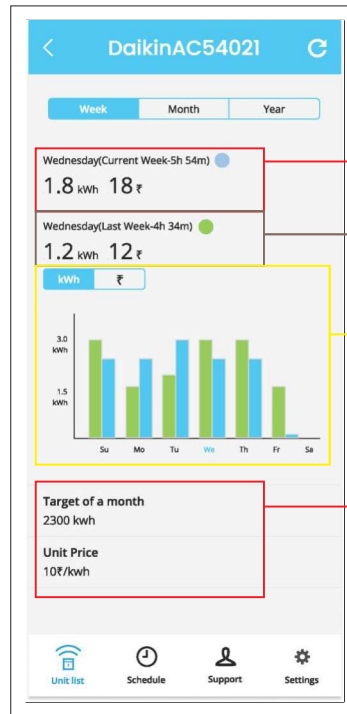

- User can view the Electricity Consumption on **Week, Month and Year** basis (as per above explanation).

- This indicates **present** weekday's, month, year electricity consumption and total time for which unit is running.
- This indicates **last** weekday's, month, year electricity consumption.
- This indicates **graphical comparison** of above data.
- User can select **price of electricity per unit and target electricity bill** of a month.

- **Note:** You can check the amount of power consumed and the electricity price in a graph.
- About graph colours in the "Week" display
  - Green:** Usage that day
  - Blue:** Last week's usage
- About graph colours in the "Month" display
  - Green :** Usage that day
  - Blue :** Last month's usage
- About graph colours in the "Year" display
  - Green :** Usage that month
  - Blue :** Previous year's usage



# ELECTRICITY CONSUMPTION FEATURE

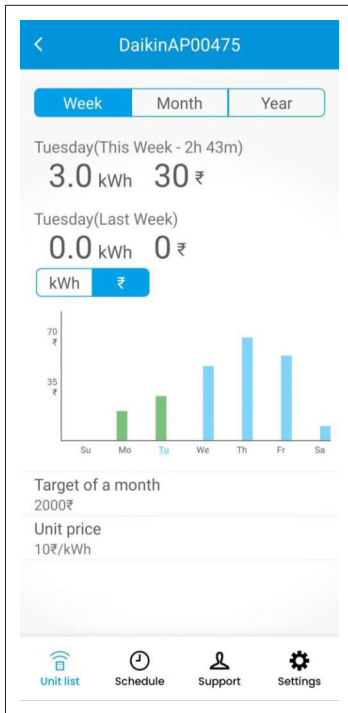

- When **Week** is selected, tap the day of the week at the bottom of the graph to display the cumulative power consumption for the selected day of the week.



- When **Month** is selected, tap the date at the bottom of the graph to display the cumulative power consumption for the selected day of the month.

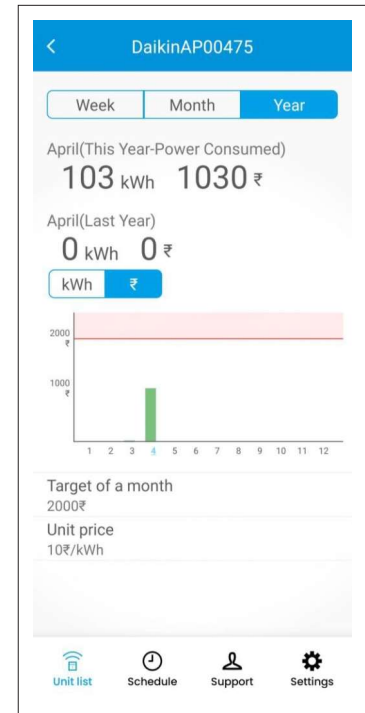

- If **Year** is selected, tap the month at the bottom of the graph to display the cumulative power consumption for the selected month.

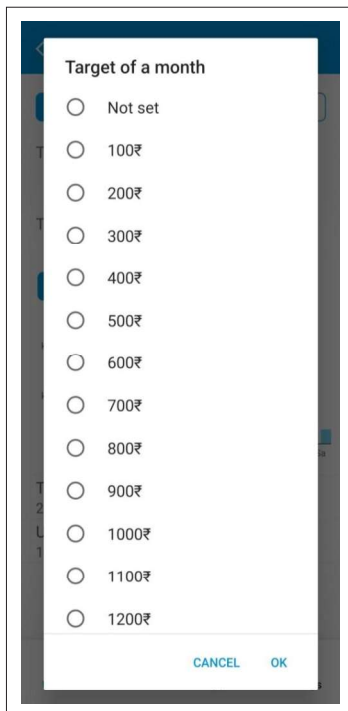

- User can select the target electricity bill of a month. Then select OK.
- You can set it from no setting to 10,000 ₹

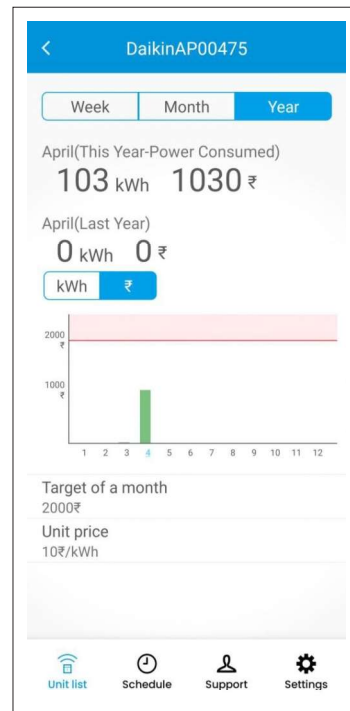

- **Red line** in graph indicates the Target of a month set by the user.

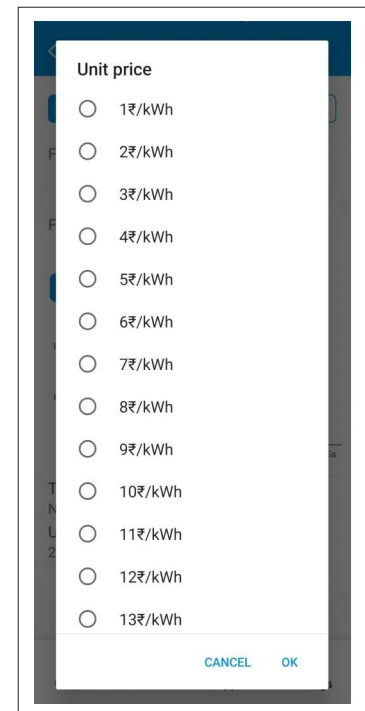

- User can select the unit price of electricity. Then select OK.

## Note :

- Electricity Consumption feature is indicative only, it can have variations from actual values.

# HOW TO USE SCHEDULE FEATURE

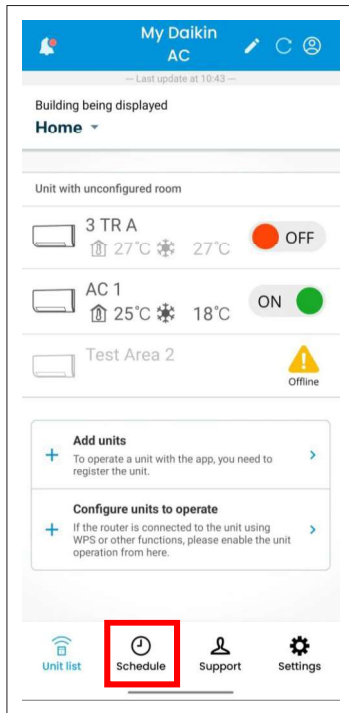

- User need to click on **Schedule Icon** (bottom side).



- Expand to see already set schedule or to set a new schedule.

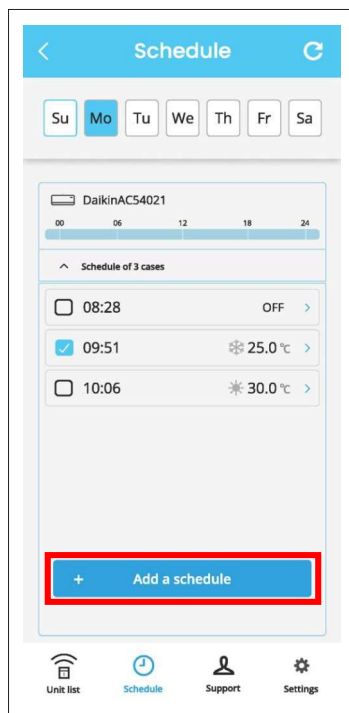

- User need to click on week day like **Monday** and click on **Add a schedule**.

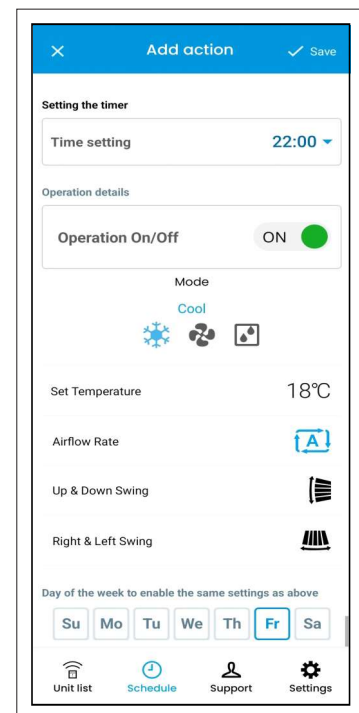

- User can now select Time (24Hr format), Unit ON/OFF, Mode(Cool, Fan, Dry) Set Temperature, Fan Speed, Swing. After selecting required setting, user need to **Save the setting** (Top Right Side).

# HOW TO USE SCHEDULE FEATURE

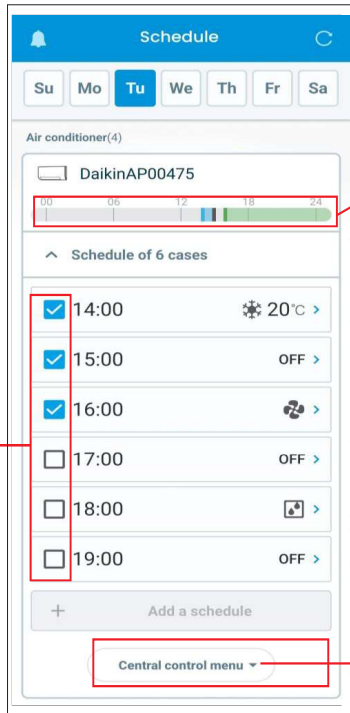

- Ticked schedules are enabled on the unit.
- Unticked schedules are disabled on the unit.

This bar represents full day (24 Hrs.) set schedules in a unit

- Blue colour represents Cool mode
- Green colour represents Fan mode
- Light Blue colour represents Dry mode
- Grey colour shows no schedule is set.

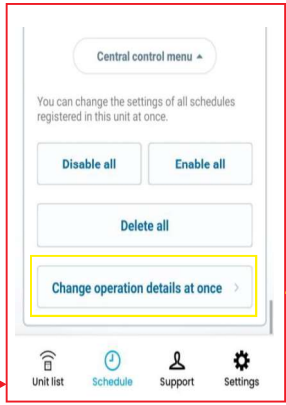

### Central control menu

- User need to tap on Central control menu at the bottom of unit schedules as shown.
- With Enable all and Disable all features, user with a single click can enable and disable all schedules of the week at one time.
- User can use **Delete all** feature to delete all the schedules for the week.

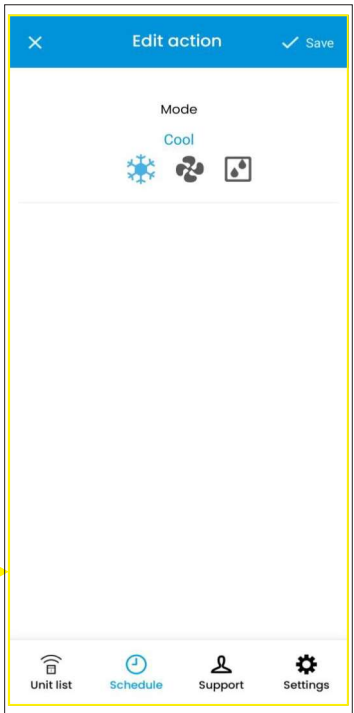

### Change operation details at once

- User can set operation mode (Cool, Fanor Dry) of all schedules set in a unit.

- Tap each item to enable or disable the corresponding timer.
- With Enable all and Disable all features, user with a single click can enable and disable all schedules of the week at one time.

**Note:-**

- User can save 06 numbers of schedule for a particular day.
- If the communication condition is poor, the time cannot be retrieved, so the schedule timer may be disabled

# HOW TO USE SCHEDULE FEATURE ON MULTIPLE UNITS

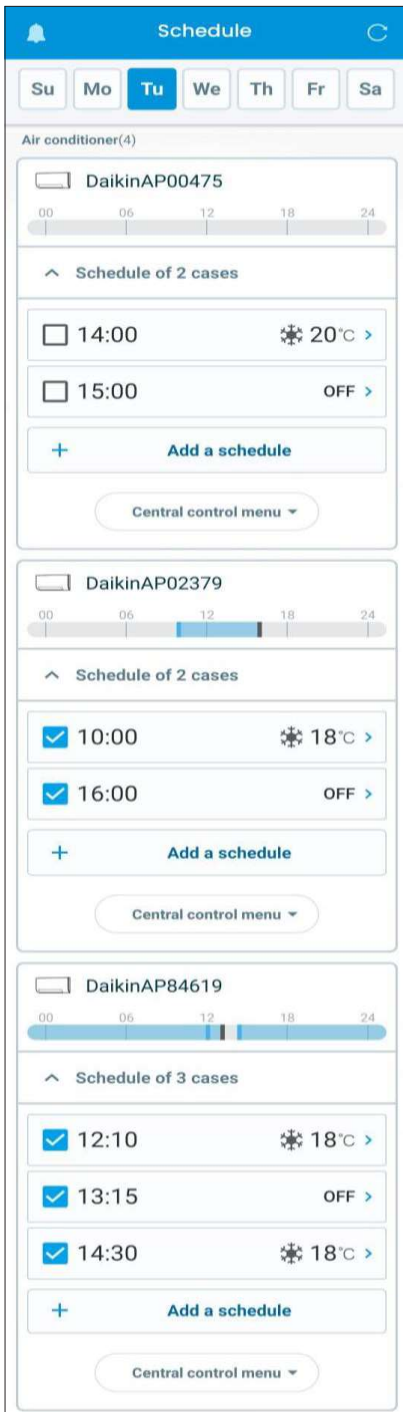

- User can view all the registered units and their set schedules on Schedule Screen.
- When you tap the operation schedule button from the individual AC unit setting screen, you cannot set the schedule for other devices.

**Note:-**

- If the communication condition is poor, the time cannot be retrieved, so the schedule timer may be disabled.
- Timer setting after the power outage is restored or when the outlet is plugged in and unplugged
- The air conditioner will match the operation of the timer of the main unit, so all settings will be changed. Since the settings are remembered, please check the settings by yourself and re-enable them.

# SUPPORT & SETTINGS SECTION

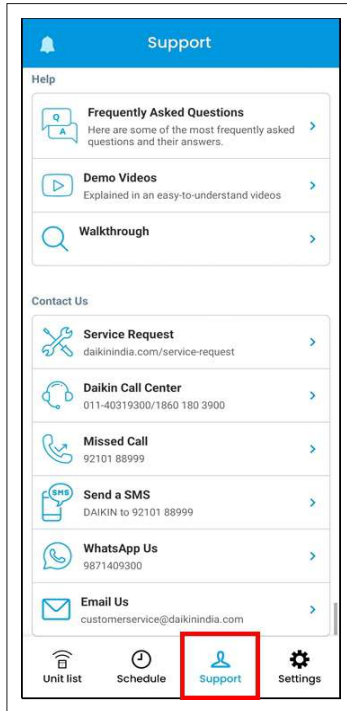

**Support Section**

- From Support Section, User can find out answers of frequently asked questions and Contact Daikin Service team through email, SMS or phone call.

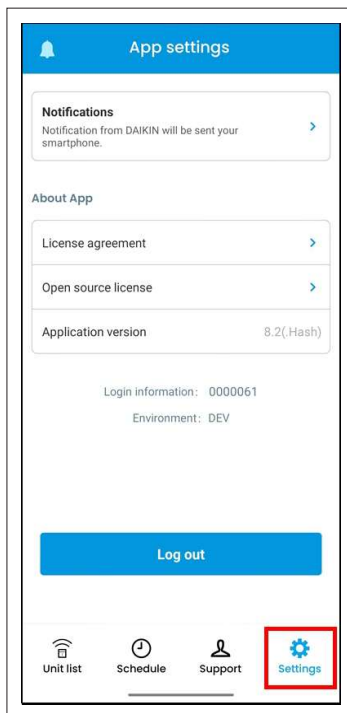

**Settings Section**

- If user wants to Log Out from the App, Read Licence Agreement and App Version; user can do this from setting section.

# PROCESS TO REMOVE AN ADDED UNIT

Turn off the unit for main supply or give SP 'Off' command by remote and wait for 5min. to appear yellow Offline icon.

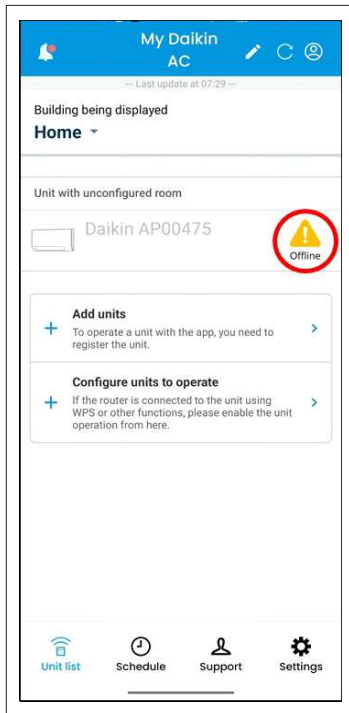

- Tap on yellow colour **Offline** icon next to the unit which you want remove on Homescreen.

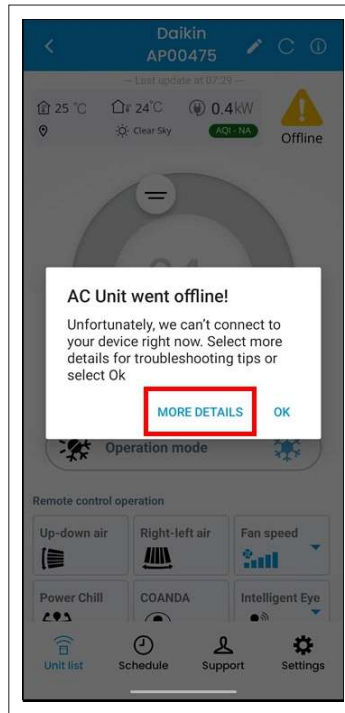

- Tap on **MORE DETAILS** to proceed further.

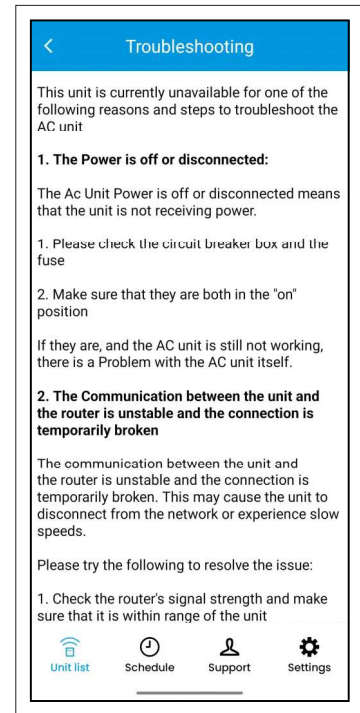

- User can read the Troubleshooting methods on this screen. Scroll down to the bottom of the screen.

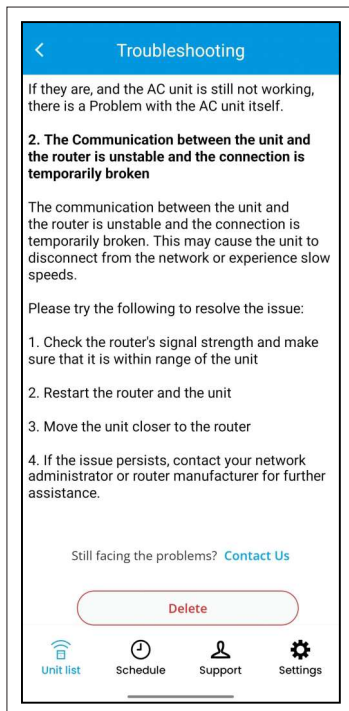

- Tap on **Delete** to remove unit from App.

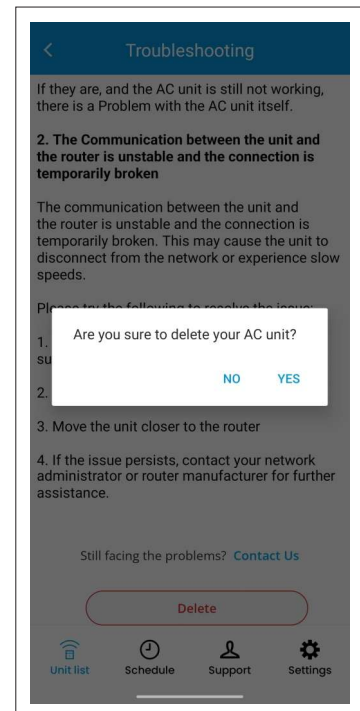

- Tap on **YES** to give confirmation.

# NOTES

- Supported OS Versions :
  - For Android OS Version →8 and above.
  - For IOS Version →14 and above.
- Home Wi-Fi Router must be operating at 2.4GHz.
- The maximum distance to add the air conditioner unit is around 7m.
- If the wireless network router is physically too away from the unit, server connection may get fail.
- The Wi-Fi module device complies with part 15 of the FCC rules. Operation is subject to the following two conditions :
  - This device may not cause harmful interference.
  - This device must accept any interference received, including interference that may cause undesired operation.
- This Wi-Fi module device complies with FCC radiation exposure limits set forth for an uncontrolled environment and meets the FCC radio frequency (RF) Exposure Guidelines. This equipment should be installed and operated keeping the radiator at least 20 cm or more away from person's body.
- If products are used in below conditions, it may damage products and leakage of electricity and abnormal temperature may occur.
  - In an atmosphere containing corrosive gas (Cl<sub>2</sub>, NH<sub>3</sub>, SO<sub>x</sub>, NO<sub>x</sub> etc.)
  - In an atmosphere containing combustible and volatile gases.
  - Dusty place.
  - Direct sunlight place.
  - Water splashing place.
  - Humid place where water condenses.
  - Freezing place.
- The Wi-Fi device specification and frequency range details are :
  - Specification** : IEEE802.11b/g/n
  - Frequency Range** : 2412-2462MHz
  - Certifications** : WPC ETA Certificate.
- WPA2 is the recommended security method for wireless network router. If the wireless network router is setup as WEP security, connection may fail.
- Features which are not applicable for a particular model can't be used through Mobile App. Users are recommended to use Streamer, Intelligent Eye features through App only if these features are present in the provided remote controller.
- Upto 50 units can be added from one login account. For comfortable operation, we recommend using around 10 units.
- The colour coding followed for different AQI ranges are mentioned below:

| AQI     | Remark       | Color Code  |
|---------|--------------|-------------|
| 0-50    | Good         | Green       |
| 51-100  | Satisfactory | Light Green |
| 101-200 | Moderate     | Yellow      |
| 201-300 | Poor         | Orange      |
| 301-400 | Very Poor    | Red-Orange  |
| 401-500 | Severe       | Red         |

- Images shown in the manual are for representation purpose, it can vary from model to model.
- Due to continuous R&D, some features can be different for different models. Please visit Daikin Home Page for more information.
- During Fan Mode, the icon colour would Turn Green whenever that particular feature is active. While during Dry Mode, the icon will Turn Light Blue colour whenever that particular feature is active.

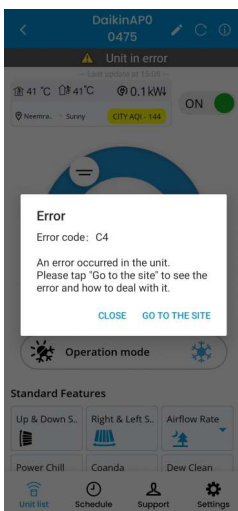

When machine is in error condition like faulty heat exchanger temperature sensor (Error code : C4) etc., a pop-up will show in App that an error occurred in the unit.



# DAIKIN AC MANAGER 2.0 – SMART SPEAKER – Amazon Alexa



## INDEX

|  |         |
|--|---------|
| 1. Alexa App Overview  | 105-107 |
| 2. Alexa Device Setup (How to Connect Alexa Speaker with Alexa Mobile App) | 108-115 |
| 3. Alexa AC Connectivity (How to Connect Alexa Speaker with AC Unit)       | 116-124 |
| 4. How to Provide Command to Alexa – Smart Speaker                         | 125-126 |

# ALEXA APP OVERVIEW

## 1. Download the App:

- Download and install the Amazon Alexa App from Google Play Store(Android OS) or iOS App Store.

## 2. Open the App:

- Once the app is installed, tap on the app icon to open it.

## 3. Sign In or Create an Account:

- If you already have an Amazon account, tap on "Sign In" and enter your Amazon account credentials (email address and password) to proceed.
- If you don't have an Amazon account, tap on "Create a new Amazon account" and follow the prompts to create one.

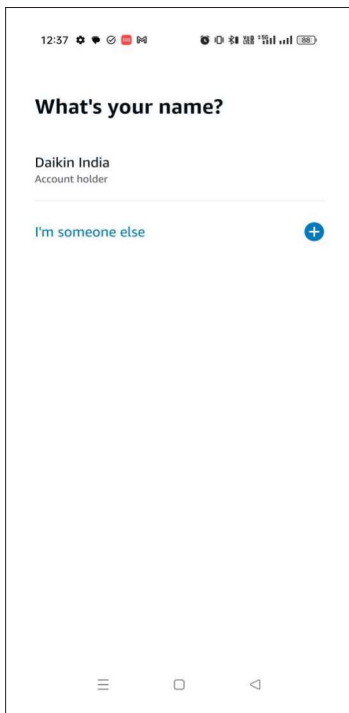
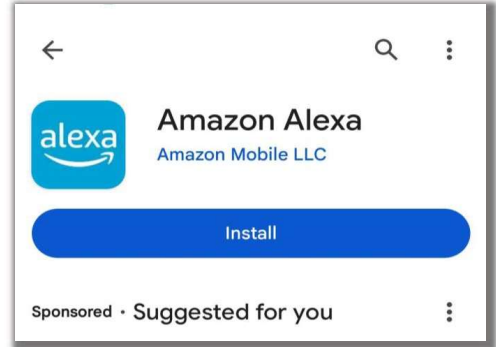

- After successfully signing in, you will see this screen. Please verify that your name is accurate. If it's correct, tap on it. If not, proceed by selecting 'I'm someone else' to complete the registration process.



- Press play button to hear how Alexa says your name or you can skip this step.

# ALEXA APP OVERVIEW



- If you agree with how Alexa pronounces your name, press 'Perfect' to confirm. If you wish to fine-tune the pronunciation, select 'Let's Sort That'.

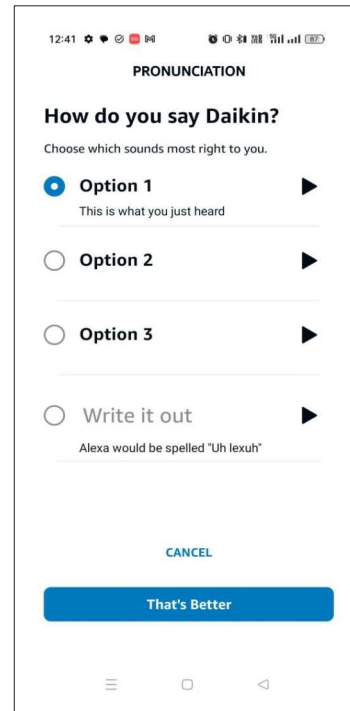

- The 'Let's Sort That' option provides various alternatives for pronouncing your name. You can choose the one that best suits your preference. And click on "That's better".

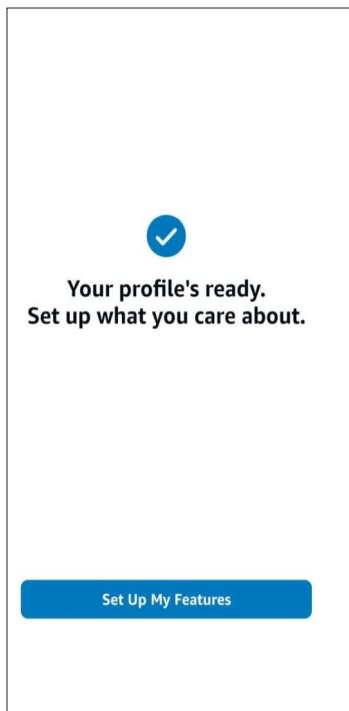

- Your account is now prepared for setup, allowing you to configure and customize your features. Let's proceed with the set 'Up My Features'.

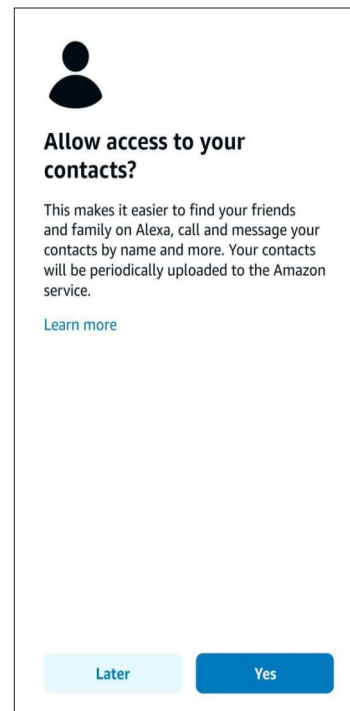

- User can allow access to their contacts or can do it Later.

# ALEXA APP OVERVIEW

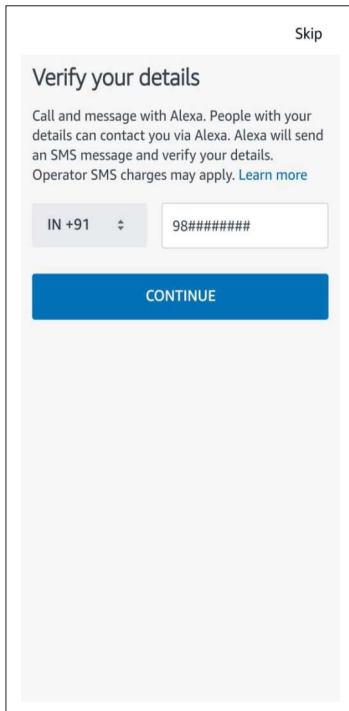

- Alexa will initiate the verification process by sending an SMS message to confirm your details

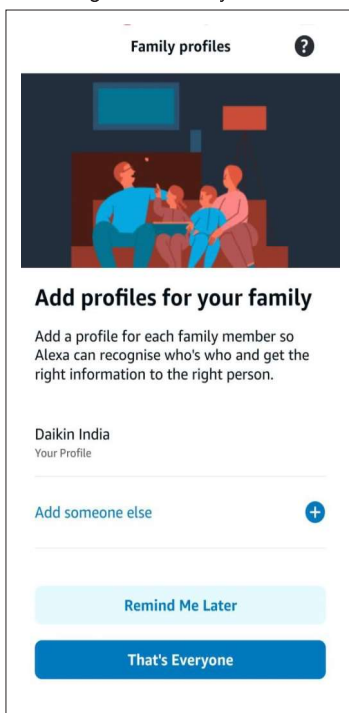

- Click on 'That's Everyone' to proceed next step or can Add Someone else.

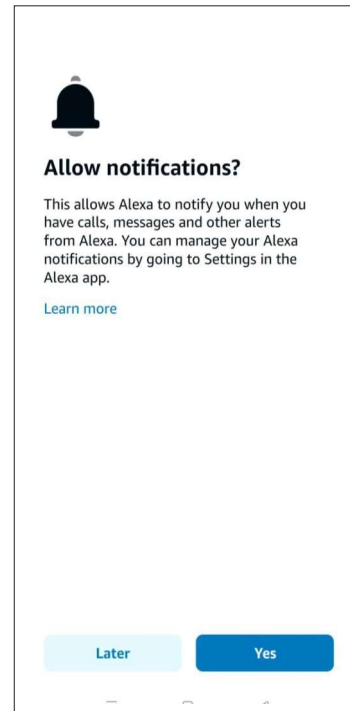

- User can accept the Allow Notifications or can do it Later.

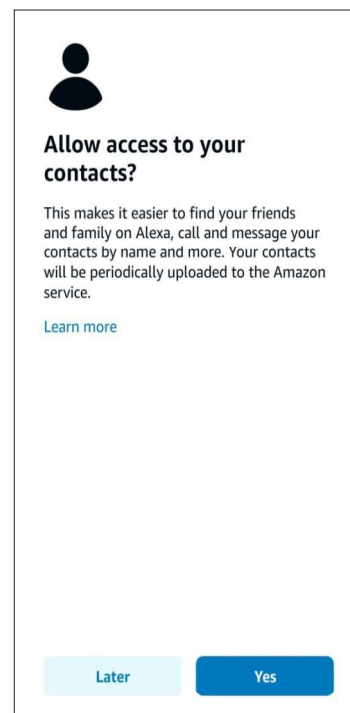

- Now user is ready to setup their Alexa device, and click on 'Done'.

# ALEXA DEVICE SETUP (How to Connect Alexa Speaker with Alexa Mobile App)

User need to follow below steps to connect Alexa Smart Speaker with Alexa Mobile App.

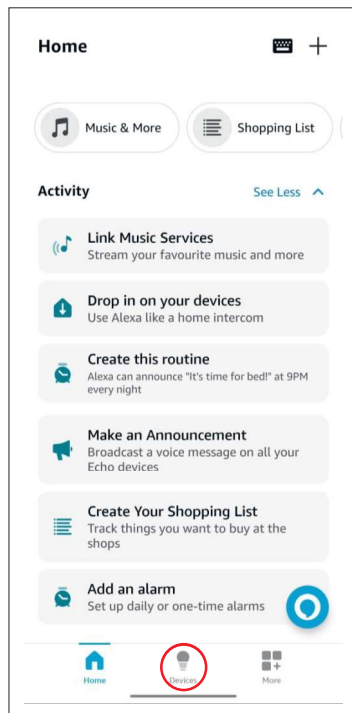

- This is home screen that is showing various features. There are three options at bottom side: Home, Devices and More. Click on 'Devices'.

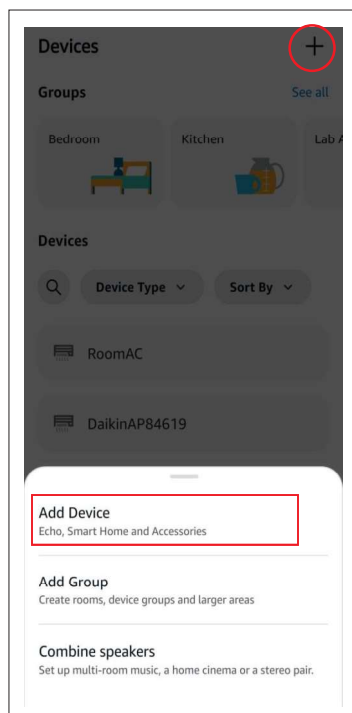

- Tap on the "+" icon in the top right corner to add a new device. To set up a new device with Alexa, tap on "Add device" on the screen.

# ALEXA DEVICE SETUP

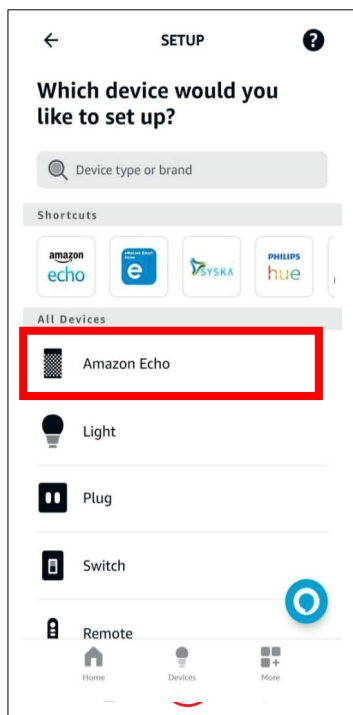

- Select "Amazon Echo" from the list of devices displayed on the screen to proceed with its setup.

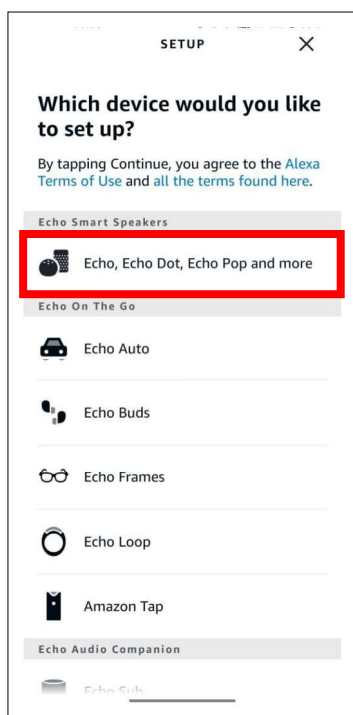

- Choose "Echo, Echo Dot, Echo Pop, and more" from the list of Echo smart speakers displayed on the screen to continue with the setup process

# ALEXA DEVICE SETUP

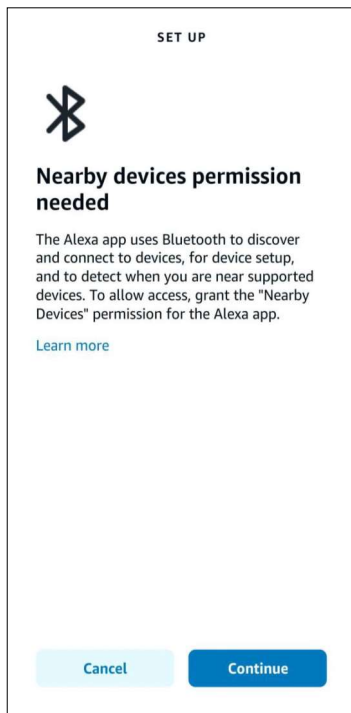

- The Alexa app utilizes Bluetooth to discover and connect to devices, facilitating device setup.

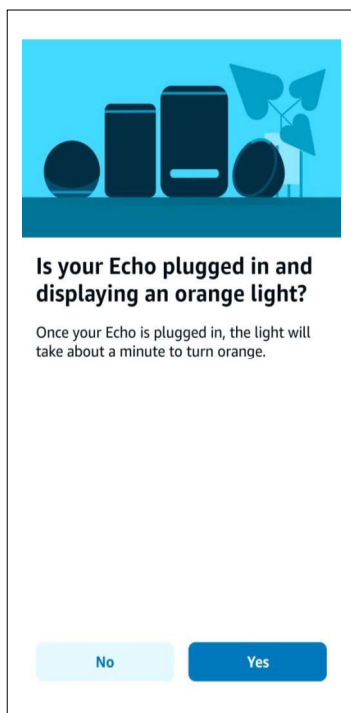

- Confirm whether your Echo device is plugged in and displaying an orange light by selecting "Yes" or "No" accordingly on the screen.



# ALEXA DEVICE SETUP

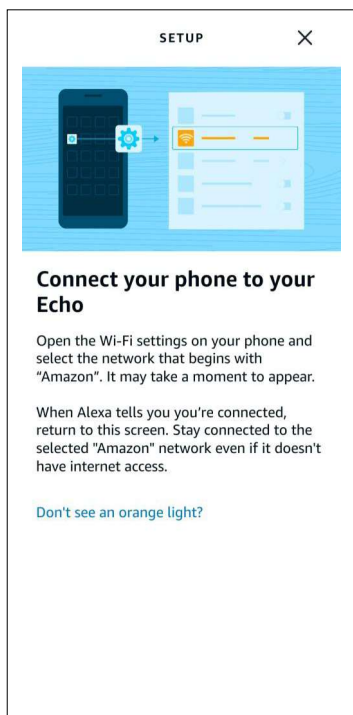

- To connect your phone to the Echo device, open the Wi-Fi settings on your phone and select the network that begins with "Amazon".

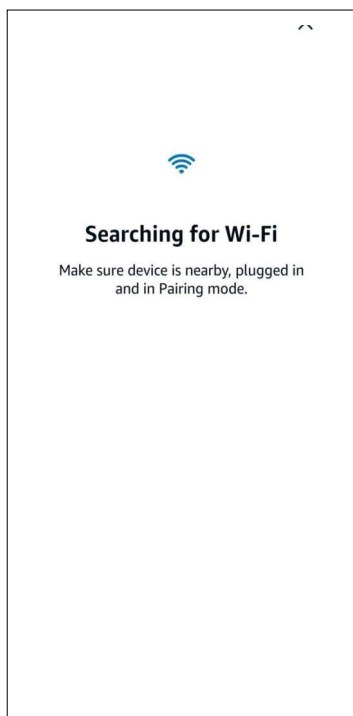

- After successfully connecting your phone to the network starting with "Amazon," return to the Alexa app, which should be running in the background. You will be directed to the "Searching your Wi-Fi" screen.

# ALEXA DEVICE SETUP

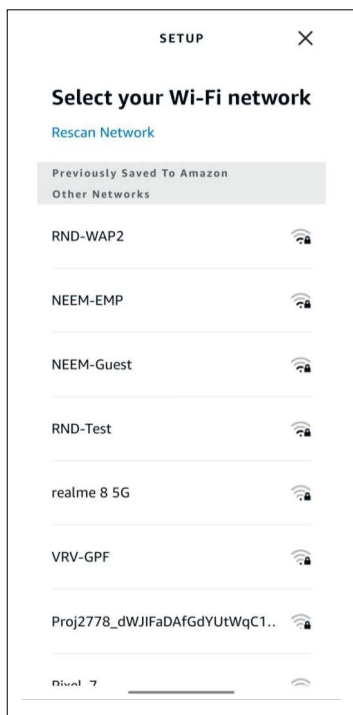

- In this screen, select your home or office Wi-Fi network from the list provided. This will connect your device to your preferred Wi-Fi network.

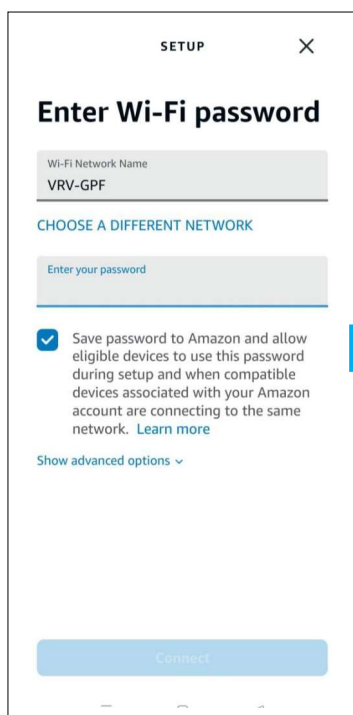

- After choosing a Wi-Fi Network; for example "VRV-GPF", then you'll need to enter the Wi-Fi password.

# ALEXA DEVICE SETUP

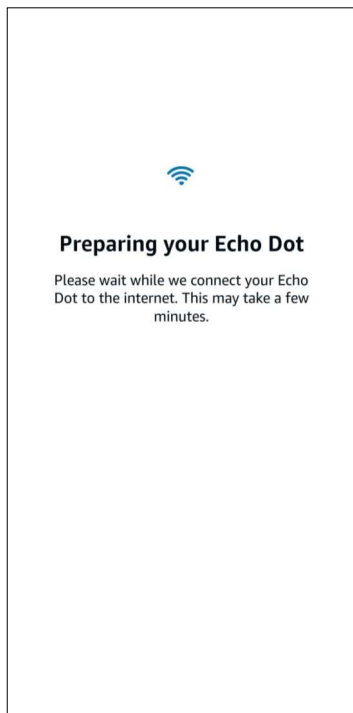

- In the subsequent screen, you will see the " Now preparing your Echo Dot" Message. This process may take a few minutes to complete.

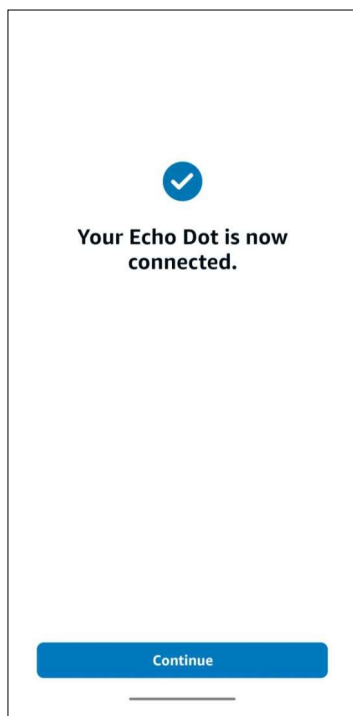

- This screen shows that your echo dot is connected.

# ALEXA DEVICE SETUP

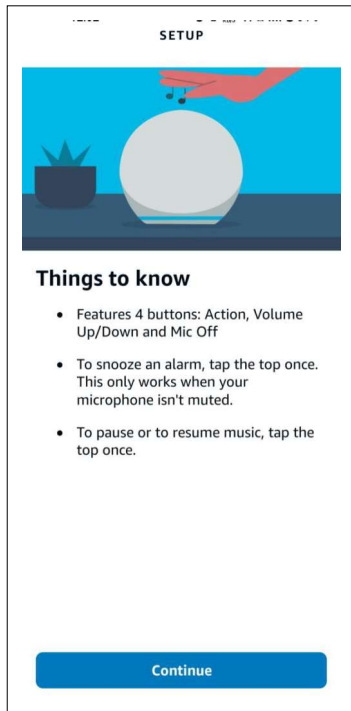

- Here are the functions of the four buttons: Action, Volume Up/Down, and Mic Off. To snooze an alarm, tap the top once. Please note that this only works when your microphone isn't muted. For pausing or resuming music, tap the top once.

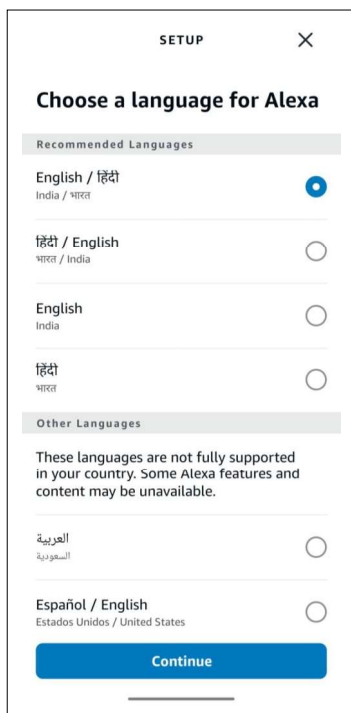

- Select a language for Alexa, and please be aware that some languages mentioned on the screen may not be fully supported.

# ALEXA DEVICE SETUP

SETUP

**Which room is your Echo Dot in?**

This will help you organise your devices.

Your Groups

Office

Common Groups

Kitchen

Dining Room

Bedroom

Master Bedroom

Guest Room

Kids Room

Skip Continue

- Indicate the room where your Echo Dot is located. This information is valuable for organizing and managing your device effectively.

**Get started with Alexa**

Your Echo Dot is ready. Next, Alexa will guide you through some things you can do.

Let's Go

- Once you have successfully connected Alexa to your Wi-Fi, you can now proceed to establish a connection between Alexa and your air conditioner.

# ALEXA – AC CONNECTIVITY (How to connect Alexa Speaker with AC Unit)

- User need to follow below steps to connect Alexa Smart Speaker with Alexa Mobile App.

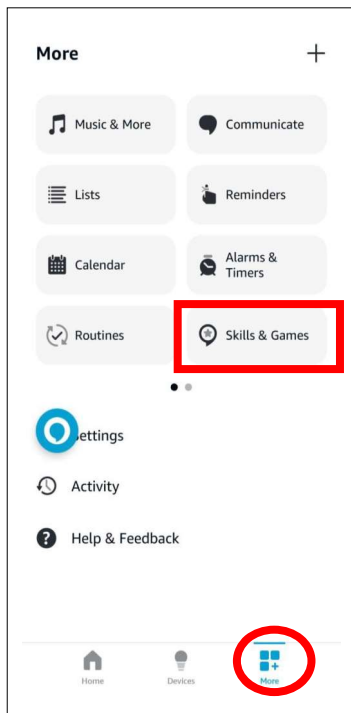

- To connect your AC unit, Please click on 'More' as shown in the screen. And then click on Skills & Games.

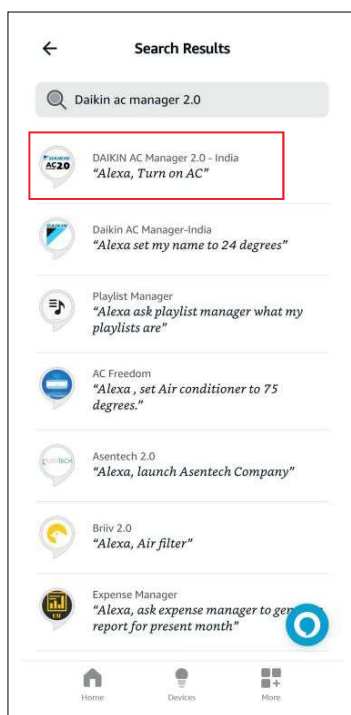

- To add Daikin AC Manager 2.0 Skills, search for "Daikin AC Manager 2.0" and tap on it.

# ALEXA – AC CONNECTIVITY

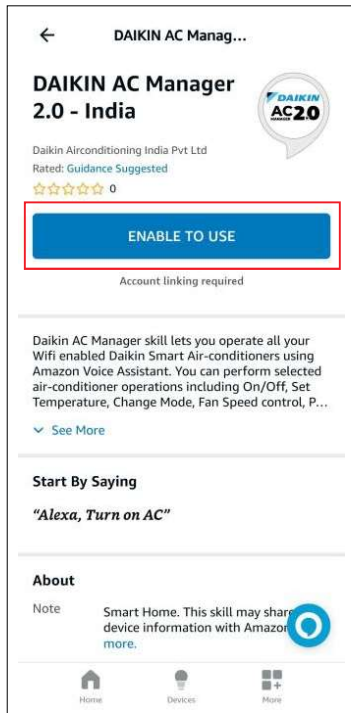

- Tap on “ENABLE TO USE” to add Daikin AC Manager 2.0 skills.

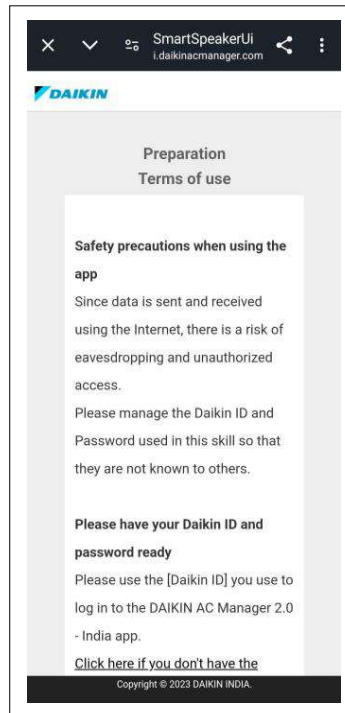

- User can read the Terms of use by scrolling down on this page.

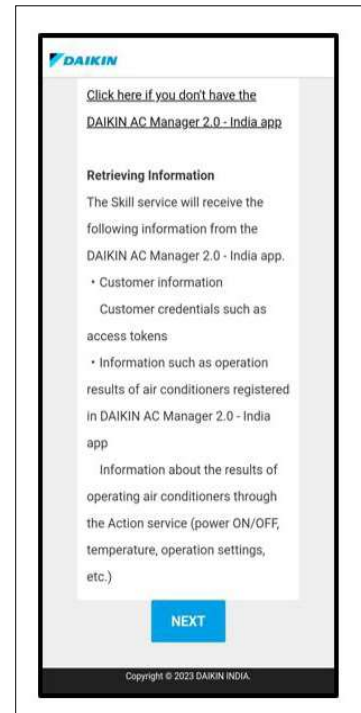

- After reading the Terms of use, Tap Next.



# ALEXA – AC CONNECTIVITY

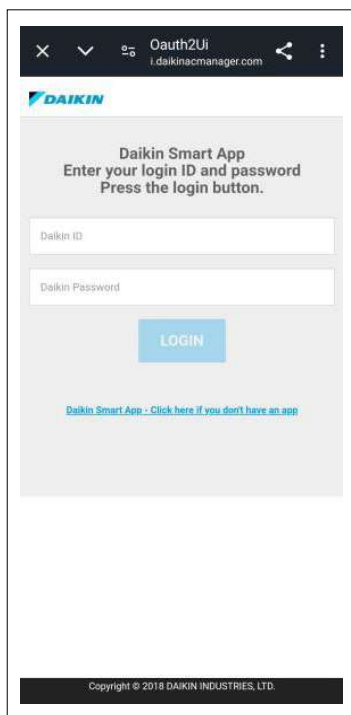

- Enter the login details same as used in Daikin Mobile App. Please mention Mobile no. As +91xxxxxxx.



- This screen indicates that Daikin AC Manager 2.0 skills has been successfully added.

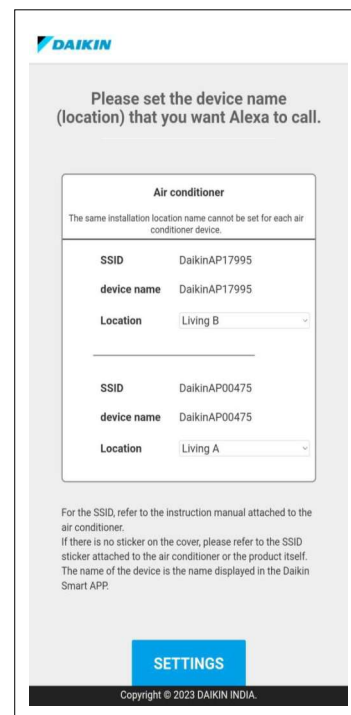

- Please set the device name that you want Alexa to call. User should not keep same location of different devices.

# ALEXA – AC CONNECTIVITY

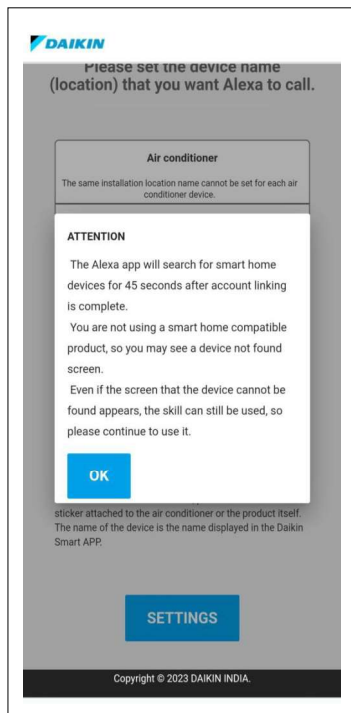

- Please follow the instructions given on the screen and click on 'OK'

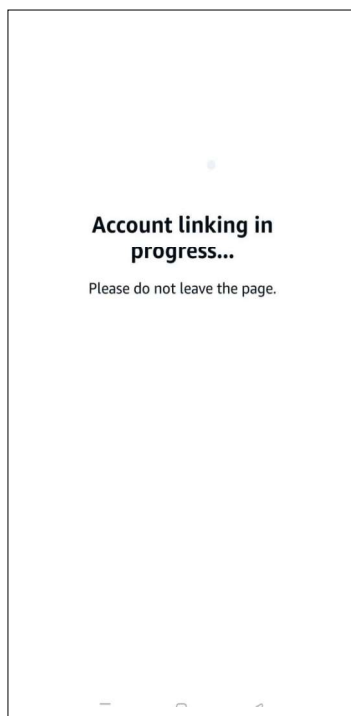

- This screen shows Account linking progress, wait for few seconds.

# ALEXA – AC CONNECTIVITY

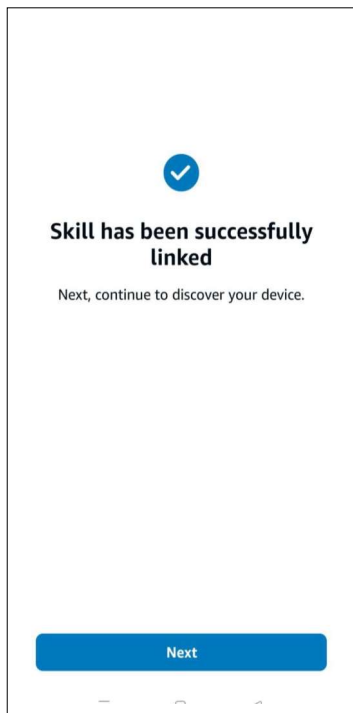

- The skill has been successfully linked. Click on 'Next'

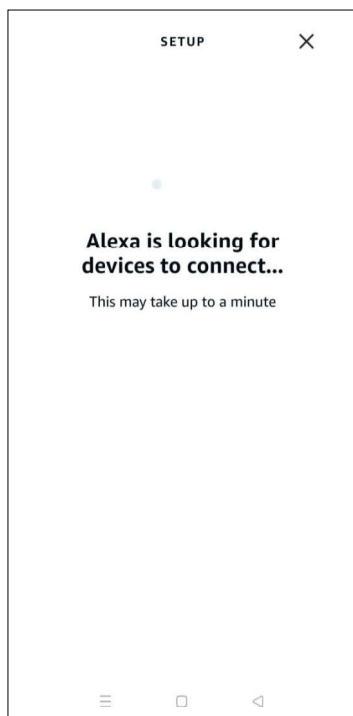

- Alexa is actively searching for devices to establish a connection. Please wait while it looks for available devices

# ALEXA – AC CONNECTIVITY

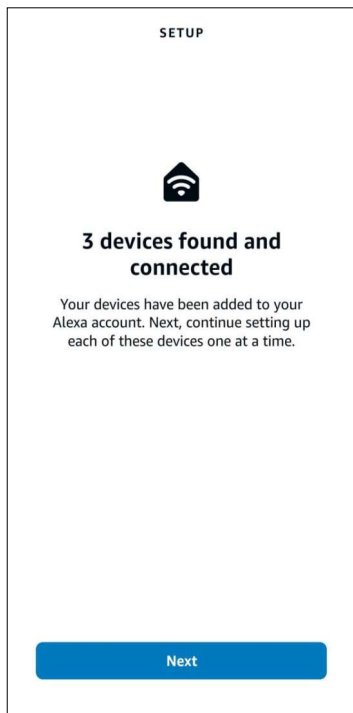

- Now User's AC unit is added to Alexa Account.

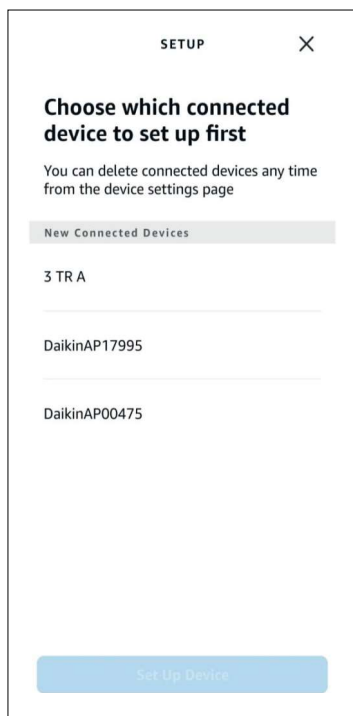

- Now user can choose particular device to setup first.

# ALEXA – AC CONNECTIVITY

SETUP

**Where is your air conditioner?**

Add your device to a group so you can control devices together and say things like, "Alexa, turn on the Living Room".

Your Groups

Bedroom

Kitchen

Lab Area

Living room

Office

Skip

Add To Group

- User need to give the location of room, so please Select a particular location and click on " Add on Group"

Setup



**DaikinAP00475 added to Office**

Now you can refer to this device using room name and device type instead of remembering the device name.

Continue

- Now "Daikin AP00475" is added to office.

# ALEXA – AC CONNECTIVITY

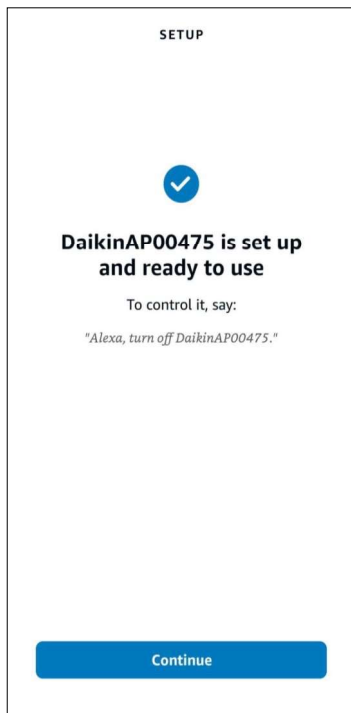

- DaikinAP00475 is set up and ready to use. To control it, say " Alexa turn on DaikinAP00475"

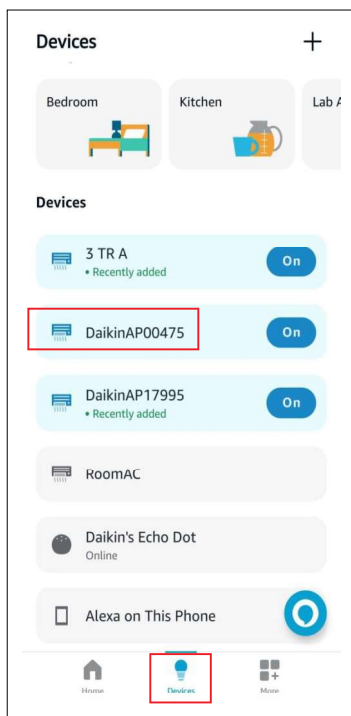

- User need to come back on Device section, and added device will appear in this section, and click on 'DaikinAP00475'

# ALEXA – AC CONNECTIVITY

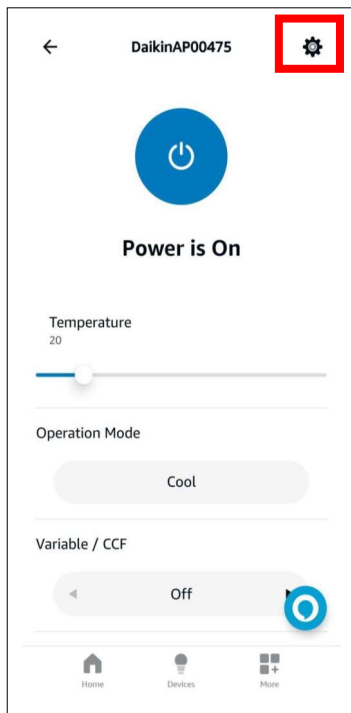

- Click on setting icon and proceed for next step.

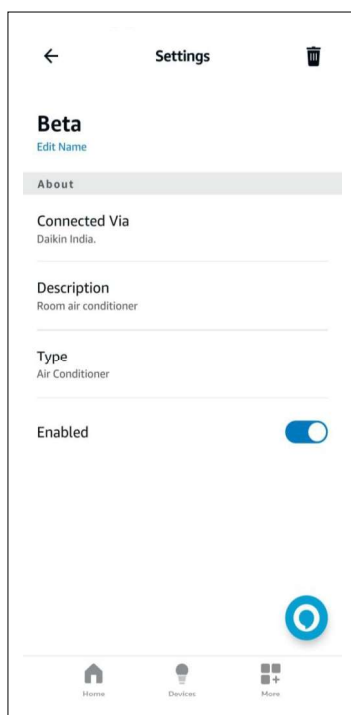

- User can edit device's name according to their own preference, Here for example, Device 'DaikinAP00475' is changed to 'Beta'.



# HOW TO PROVIDE COMMAND TO ALEXA - SMART SPEAKER :

| ALEXA        |                    |  |
|--------------|--------------------|--|
| Sr. No.      | Feature            | Voice Command Statement  |
| In Cool Mode |                    |  |
| 1            | ON/OFF             | Alexa! Turn ON/OFF 'AC name'   |
| 2            | Operation Mode     | Alexa! Set/Change "AC name" to Cool/Dry/Fan  |
| 3            | Set Temperature    | Alexa! Set Temperature to 18/19/20.../32 on "AC name"  |
|              |                    | Alexa! Increase/Decrease Temperature by 1/2/3/.../14 on "AC name"  |
| 4            | Fan Speed          | Alexa! Set Fan Speed to Auto/ Indoor Unit Quiet/ Low/ Medium Low/ Medium/ Medium High/ High on "AC name" |
| 5            | Up & Down Swing    | Alexa! Turn ON/OFF Up-down flap on "AC name"   |
| 6            | Right & Left Swing | Alexa! Turn ON/OFF Left-right flap on "AC name"  |
| 7            | Power Chill        | Alexa! Turn ON/OFF Power Chill on "AC name"  |
| 8            | Coanda             | Alexa! Enable/Disable Coanda on "AC name"  |
| 9            | Streamer           | Alexa! Turn ON/OFF Streamer on "AC name"   |
| 10           | I-Eye Energy Saver | Alexa! Turn ON/OFF Energy Saver on "AC name"   |
| 11           | I-Eye Auto ON/OFF  | Alexa! Turn ON/OFF Auto On/Off on "AC name"  |
| 12           | Dew Clean          | Alexa! Turn ON/OFF Dew Clean on "AC name"  |
| 13           | Outdoor Quiet      | Alexa! Turn ON/OFF Outdoor Quiet on "AC name"  |
| 14           | Variable           | Alexa! Set Variable to L1/L2/L3/ L4/L5/OFF on "AC name"  |
| In Dry Mode  |                    |  |
| 1            | ON/OFF             | Alexa! Turn ON/OFF 'AC name'   |
| 2            | Operation Mode     | Alexa! Set/Change "AC name" to Cool/Dry/Fan  |
| 3            | Up & Down Swing    | Alexa! Turn ON/OFF Up-down flap on "AC name"   |
| 4            | Right & Left Swing | Alexa! Turn ON/OFF Left-right flap on "AC name"  |
| 5            | Power Chill        | Alexa! Turn ON/OFF Power Chill on "AC name"  |
| 6            | Coanda             | Alexa! Enable/Disable Coanda on "AC name"  |
| 7            | Streamer           | Alexa! Turn ON/OFF Streamer on "AC name"   |
| 8            | I-Eye Energy Saver | Alexa! Turn ON/OFF Energy Saver on "AC name"   |
| 9            | I-Eye Auto ON/OFF  | Alexa! Turn ON/OFF Auto On/Off on "AC name"  |
| 10           | Dew Clean          | Alexa! Turn ON/OFF Dew Clean on "AC name"  |
| 11           | Variable           | Alexa! Set Variable to L1/L2/L3/ L4/L5/OFF on "AC name"  |

# HOW TO PROVIDE COMMAND TO ALEXA - SMART SPEAKER :

| Sr. No.   | Feature   | Voice Command Statement  |
|---|---|--|
| <b>In Fan Mode</b>  |   |  |
| 1   | ON/OFF  | Alexa! Turn ON/OFF 'AC name'   |
| 2   | Operation Mode  | Alexa! Set/Change "AC name" to Cool/Dry/Fan  |
| 3   | Fan Speed   | Alexa! Set Fan Speed to Auto/ Indoor Unit Quiet/ Low/ Medium Low/ Medium/ Medium High/ High on "AC name" |
| 4   | Up & Down Swing   | Alexa! Turn ON/OFF Up -down flap on "AC name"  |
| 5   | Right & Left Swing  | Alexa! Turn ON/OFF Left -right flap on "AC name"   |
| 6   | Power Chill   | Alexa! Turn ON/OFF Power Chill on "AC name"  |
| 7   | Coanda  | Alexa! Enable/Disable Coanda on "AC name"  |
| 8   | Streamer  | Alexa! Turn ON/OFF Streamer on "AC name"   |
| 9   | I-Eye Energy Saver  | Alexa! Turn ON/OFF Energy Saver on "AC name"   |
| 10  | I-Eye Auto ON/OFF   | Alexa! Turn ON/OFF Auto On/Off on "AC name"  |
| 11  | Dew Clean   | Alexa! Turn ON/OFF Dew Clean on "AC name"  |
| <b>Status Commands</b>  |   |  |
| 1   | Operation Mode  | Alexa! Which Operation Mode is the "AC name" set to?   |
| 2   | Set Temperature<br>(Not applicable in Dry Mode and Fan Mode)        | Alexa! What is the current Set Temperature on "AC name" ?  |
| 3   | Fan Speed<br>(Not applicable in Dry Mode and Power Chill operation) | Alexa! What is the Fan Speed in "AC name"?   |
| 4   | Up & Down Swing   | Alexa! Is Up -down flap ON in "AC name" ?  |
| 5   | Right & Left Swing  | Alexa! Is Left-right flap ON in "AC name"?   |
| 6   | Power Chill   | Alexa! Is Powerchill ON in "AC name"?  |
| 7   | Coanda  | Alexa! Is Coanda ON in "AC name"?  |
| 8   | Streamer  | Alexa! Is Streamer ON in "AC name"?  |
| 9   | I-Eye Energy Saver  | Alexa! Is Energy Saver ON in "AC name" ?   |
| 10  | I-Eye Auto ON/OFF   | Alexa! Is Auto On/Off ON in "AC name"?   |
| 11  | Dew Clean   | Alexa! Is Dew clean ON in "AC name" ?  |
| 12  | Outdoor Quiet<br>(Not applicable in Dry Mode and Fan Mode)          | Alexa! Is Outdoor Quiet ON in "AC name"?   |
| 13  | Variable<br>(Not applicable in Fan mode)                            | Alexa! Is Variable ON in "AC name"?  |
| <p><b>Note:</b></p> <ol style="list-style-type: none"> <li>1. If AC name is set to 'Bedroom AC' then command will be<br/>→ Alexa! Turn ON Bedroom AC</li> <li>2. Voice commands other than the above mentioned voice commands may not work properly.</li> <li>3. If Smart Speaker doesn't respond, Please re-check the above setup process or internet connection.</li> </ol> |   |  |

# DAIKIN AC MANAGER 2.0 SMART SPEAKER – Google Home



Google Home

## INDEX

|  |         |
|--|---------|
| 1. Google Home App .....   | 128-131 |
| 2. How to Connect Google Home App and Google Home Speaker .....        | 132-135 |
| 3. How to Connect Google Home Smart Speaker and Daikin Smart App ..... | 136-143 |
| 4. How to Provide Command to Google Home – Smart Speaker .....         | 144-145 |

# GOOGLE HOME APP

## 1. Download the App:

- Download and install the Google Home App from Google Play Store(Android OS) or iOS App Store.

## 2. Open the App:

- Once the app is installed, tap on the app icon to open it.

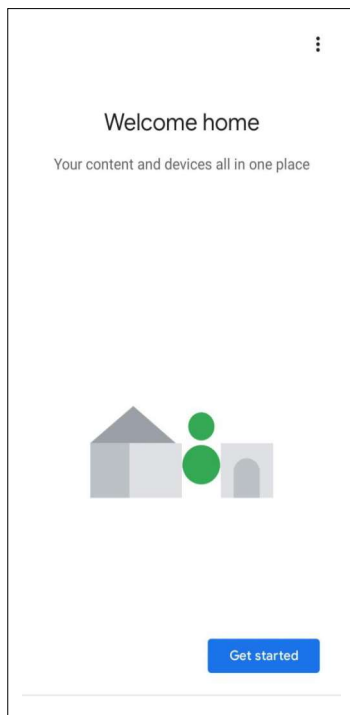
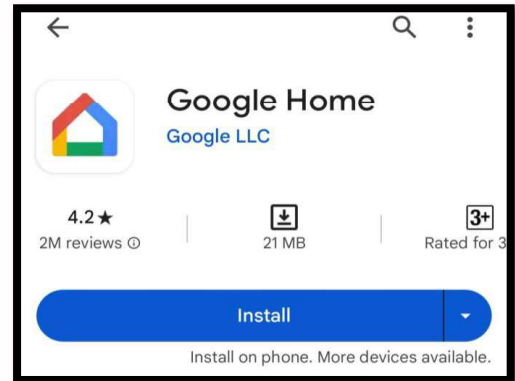

- After tapping the app icon, you'll encounter this screen. Proceed to the next step by clicking on "Get started".

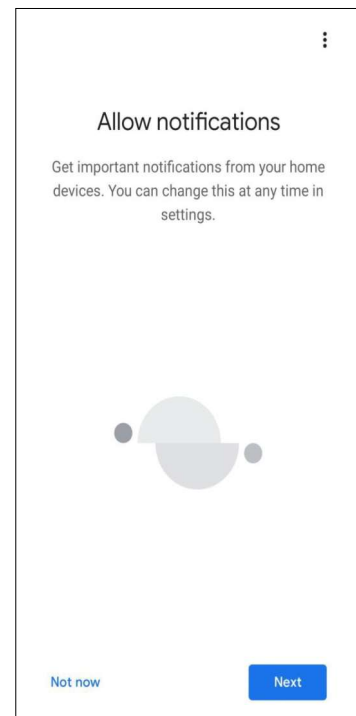

- User will get important notifications from this app, this setting can be change at any time later, click on 'Next'.

# GOOGLE HOME APP

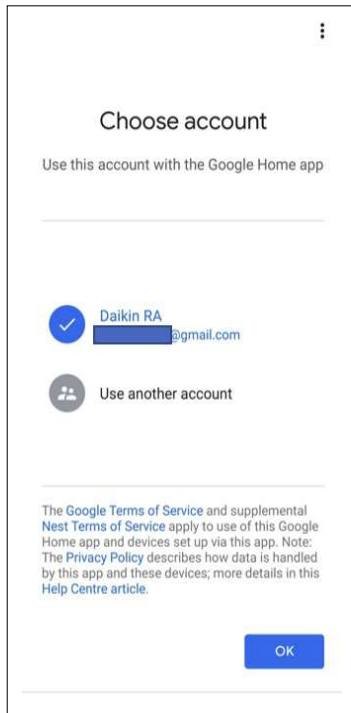

- Select the email address user would like to use for logging in, or click on 'Use another account'.

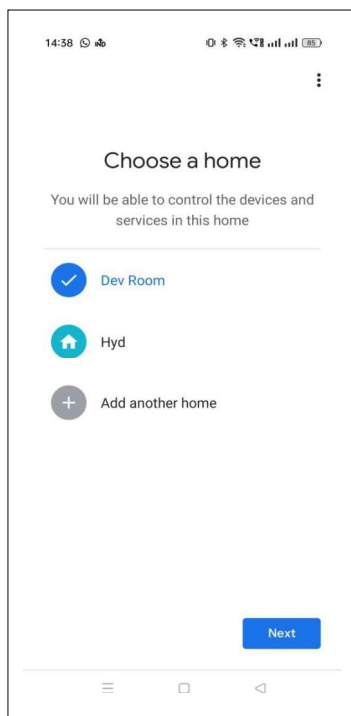

- Select the location where you want to control your devices, and click on 'Next'.

# GOOGLE HOME APP

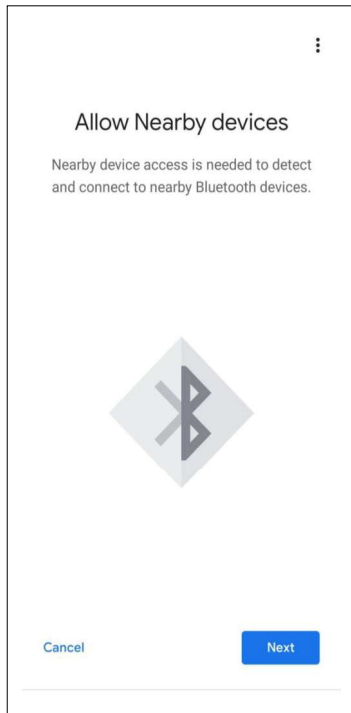

- Proceed with this instruction, and Click ' Next'.

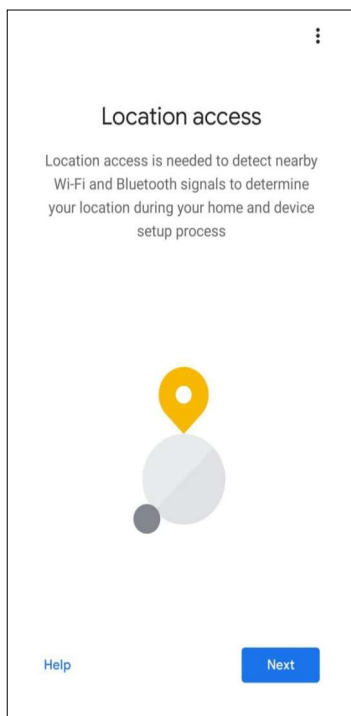

- Grant location access to allow detection of Wi-Fi and Bluetooth signals for the device setup process, and click 'Next'.

# GOOGLE HOME APP

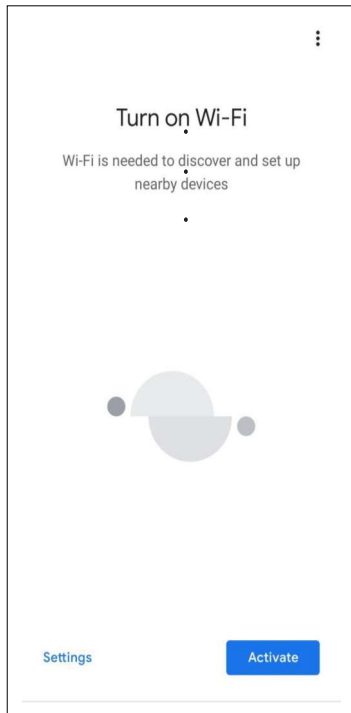

- Proceed according to screen, and click on the 'Activate'

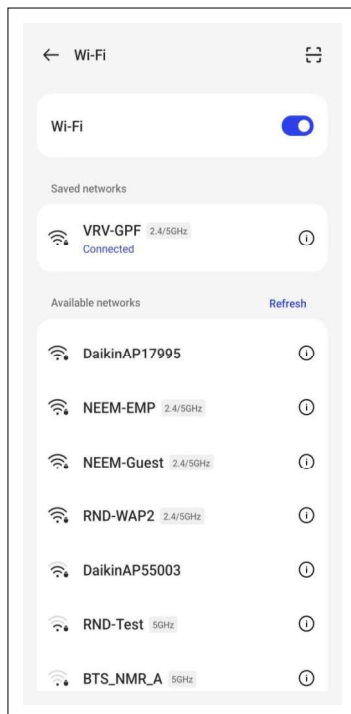

- Select the Wi-Fi, and Proceed next.

# GOOGLE HOME APP + GOOGLE HOME SMART SPEAKER

- User needs to follow the below steps to connect with the Google Home Smart Speaker with the Home Router.

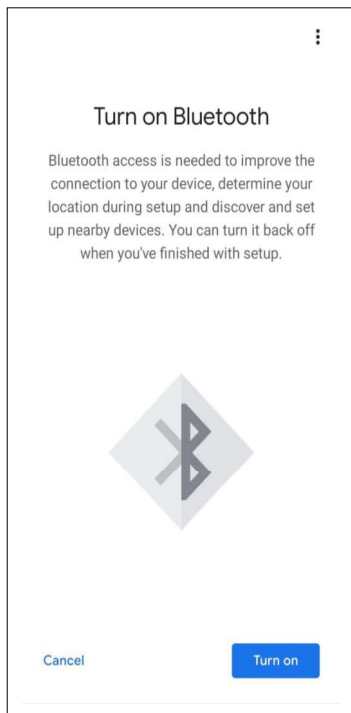

- User need to turn on their Bluetooth, and click on 'turn on'.

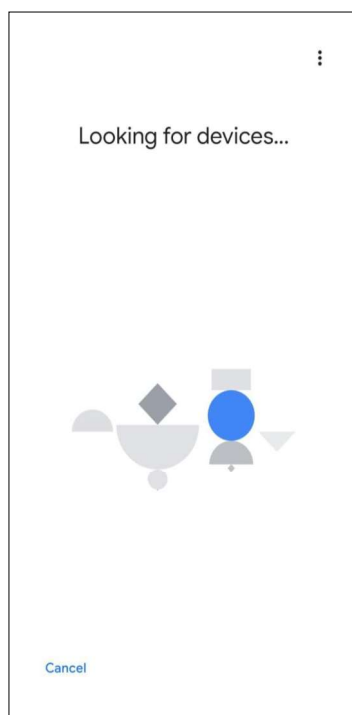

- Proceed according to screen and ensure that your Google Nest Device is plugged in.



# GOOGLE HOME APP + GOOGLE HOME SMART SPEAKER

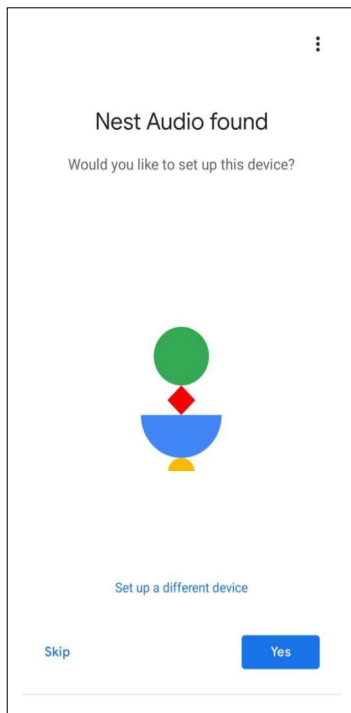

- After few seconds Google Home will find the Nest Audio, and this screen appears.

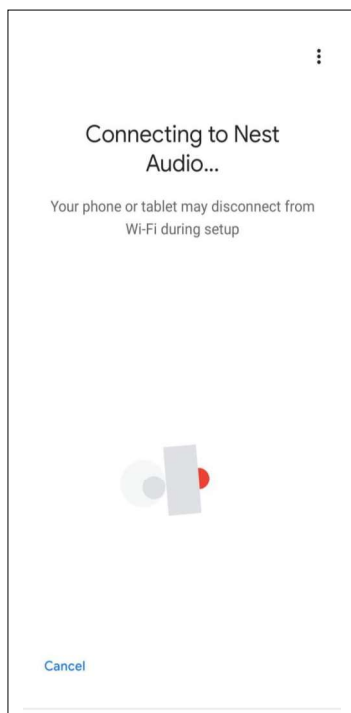

- This screen will appear at the time of connecting.

# GOOGLE HOME APP + GOOGLE HOME SMART SPEAKER

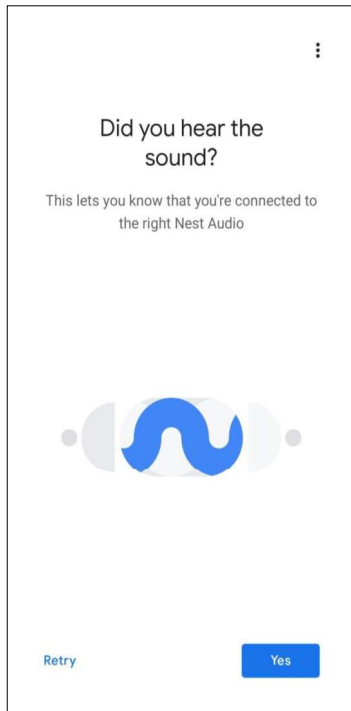

- Just after connection, user will hear sound it is indication that you are connected with right Nest Audio Device if it is right then click 'Yes'.

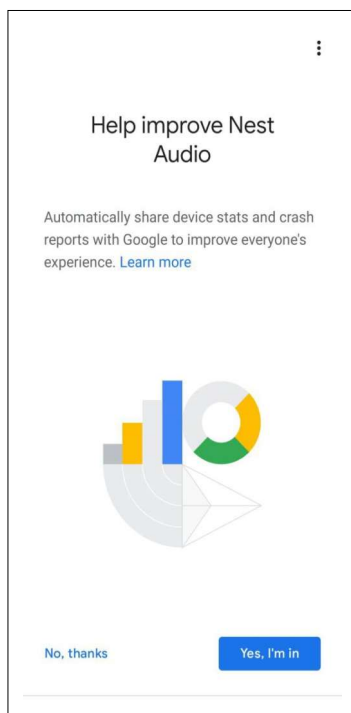

- Proceed according to the screen, and click 'Yes, I'm in'.

# GOOGLE HOME APP + GOOGLE HOME SMART SPEAKER

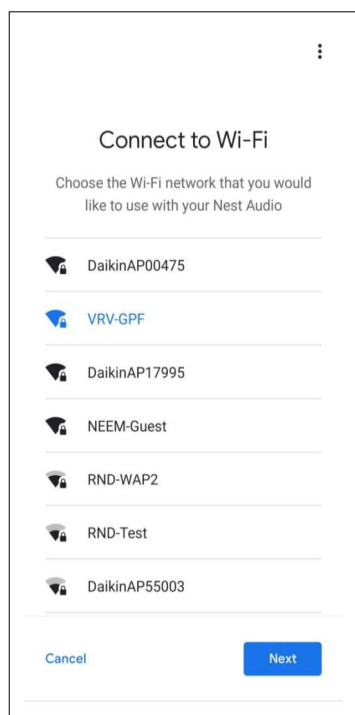

- User need to choose the Wi-Fi network that they would like to use with Smart Speaker. User can choose from the list for example, VRV-GPF and click on 'Next'.

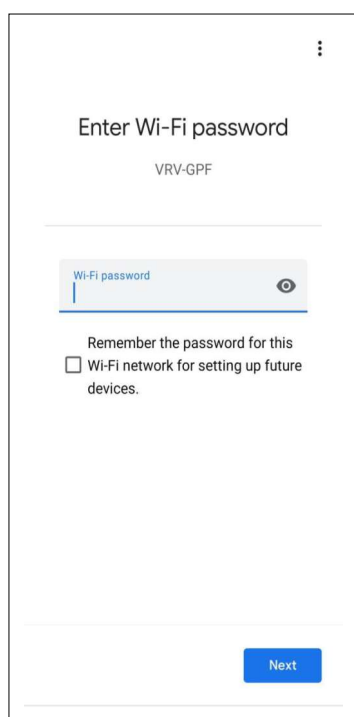

- User need to enter the Wi-Fi password and proceed to next step click on 'Next'.

# GOOGLE HOME SMART SPEAKER + DAIKIN SMART APP

- User needs to follow the below steps to connect with the Google Home Smart Speaker with the Daikin Mobile App.

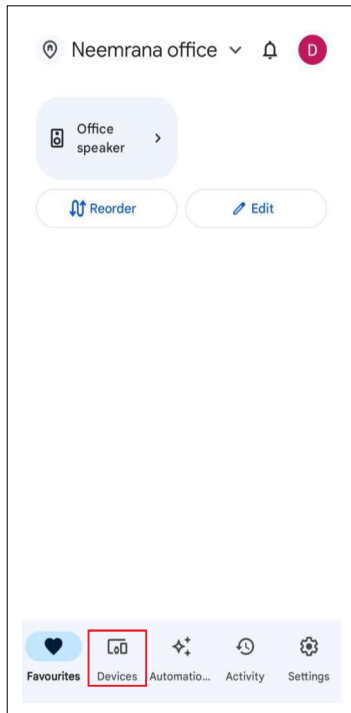

- Select the 'Device' option as shown in the screen.

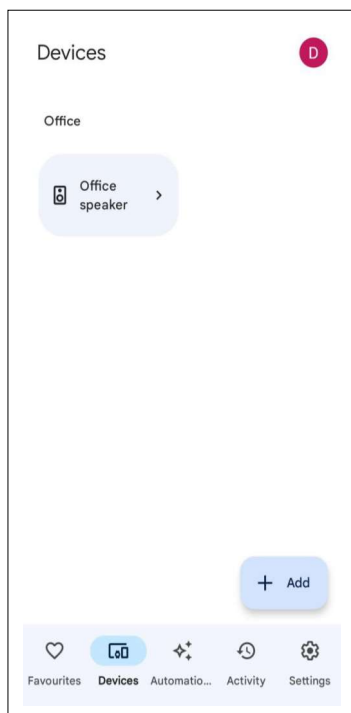

- Click on '+ Add' to add the devices like Speakers, AC units etc.

# GOOGLE HOME + DAIKIN SMART APP

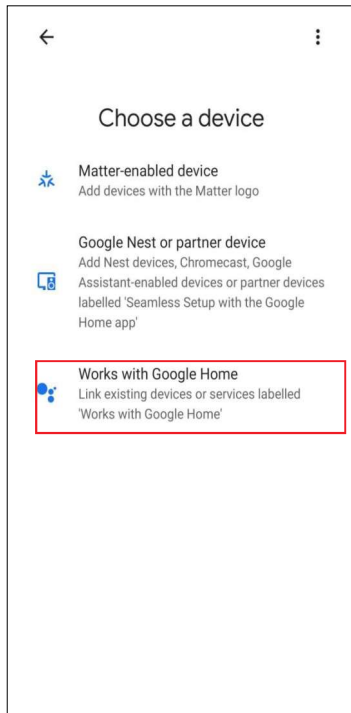

- Select the 'Work with Google Home' option as shown in the screen.

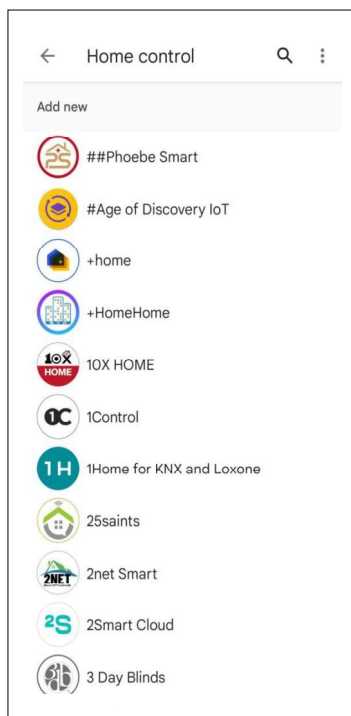

- This is Home Control of GoogleHome. Search "Daikin AC Manager 2.0 - India" here to add Daikin AC Manager 2.0 skills.

# GOOGLE HOME + DAIKIN SMART APP



- Select the "Daikin AC Manager 2.0 – India" and proceed next

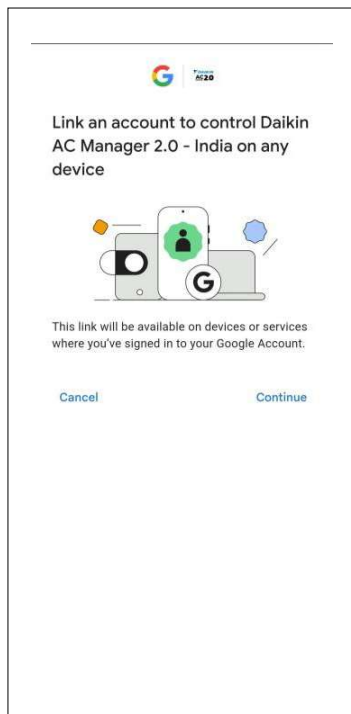

- Click on 'Continue', and proceed to Next Step.

# GOOGLE HOME + DAIKIN SMART APP

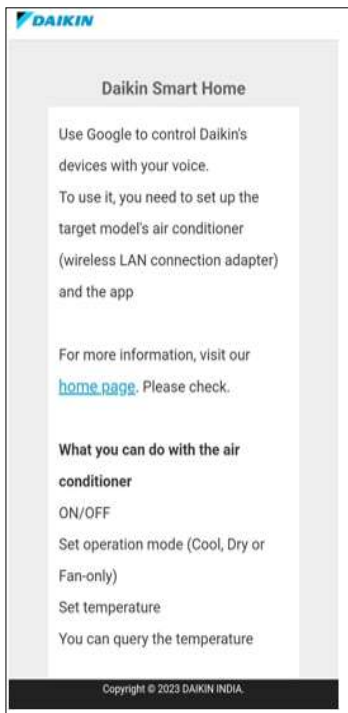

- User will be re-directed to this page, go through the instructions and scroll down button.

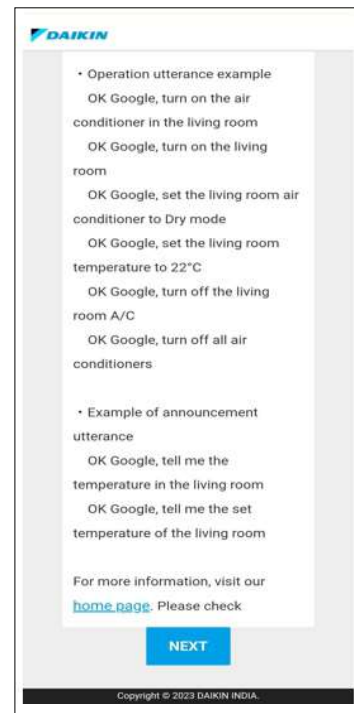

- After reading the instructions and tap 'Next'

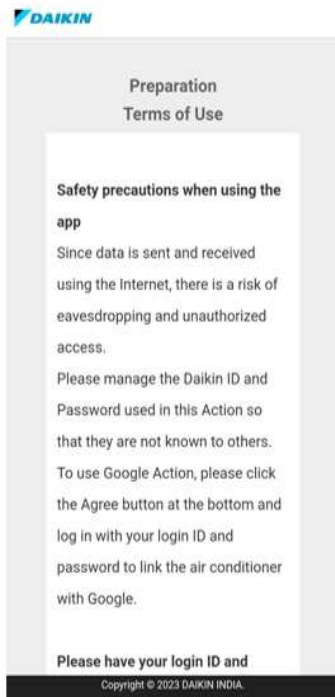

- This screen shows Safety Precautions when using the App, go through this and click on ' I AGREE TO THE TERMS OF USE'

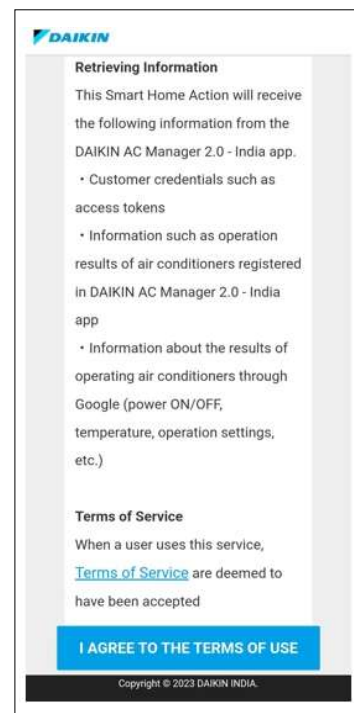

# GOOGLE HOME + DAIKIN SMART APP

Daikin Smart App  
Enter your login ID and password  
Press the login button.

By signing in, you are authorizing Google to control your devices.

Daikin ID

Daikin Password

LOGIN

[Daikin Smart App - Click here if you don't have an app.](#)

Copyright © 2018 DAIKIN INDUSTRIES, LTD.

- Enter the login details same as used in Daikin AC Manager 2.0 App. Click on 'LOGIN'.

Please set the name (installation location) to be called to Google.

**Air conditioner**  
The same installation location name cannot be set for each air conditioner device.

SSID DaikinAP04603

device name DaikinAP04603

Location living room

ADD DEVICE(S)

For the SSID, refer to the instruction manual attached to the air conditioner.  
If there is no sticker on the cover, please refer to the SSID sticker attached to the air conditioner or the product itself.  
The name of the device is the name displayed in the DAIKIN AC Manager 2.0 - India app.

Copyright © 2023 DAIKIN INDIA.

- Please set the Name and location of unit to be called to Google, and click on 'SETTINGS'.



# GOOGLE HOME + DAIKIN SMART APP

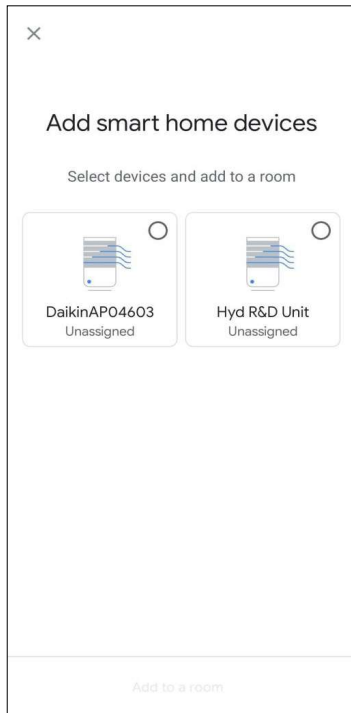

- Choose the devices that needed to add in room and click on 'Add to a room'.

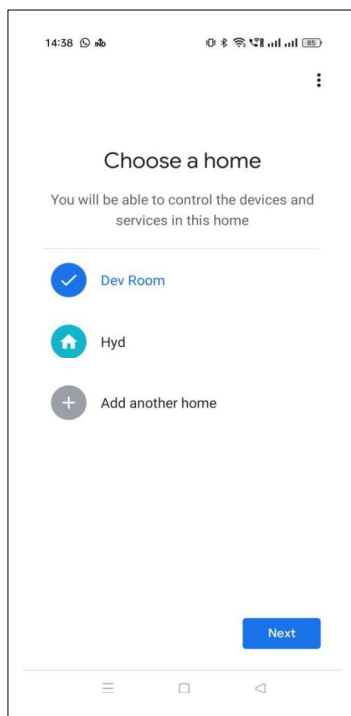

- The user should select the location Where the unit (or) device will be Installed and then click 'NEXT'

# GOOGLE HOME + DAIKIN SMART APP



- This screen will appear in the device section after adding different units .
- To change the name of any unit, click on the unit.

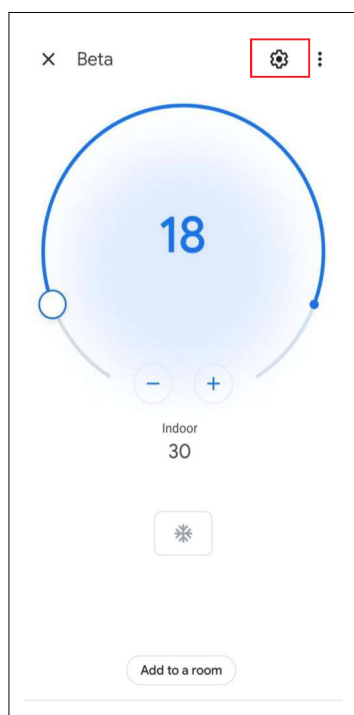

- User need to click on setting and proceed to next.

# GOOGLE HOME + DAIKIN SMART APP



- User need to click on 'name' and proceed to change name.

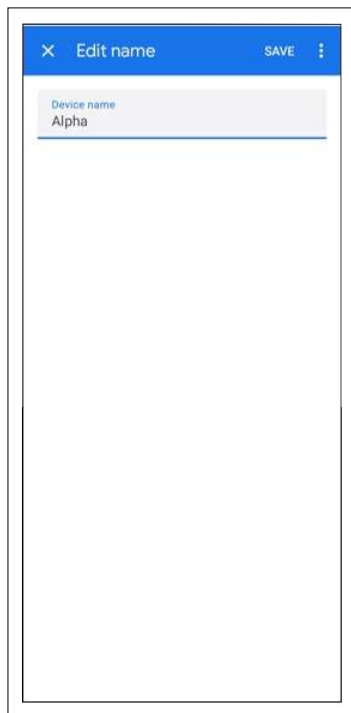

- This screen appear for name change of unit. Once name changed user should say "Okey Google" Turn on Appha" then Unit referring Alpha will be on.

# HOW TO PROVIDE COMMAND TO GOOGLE HOME - SMART SPEAKER

| GOOGLE HOME  |                    |   |
|--------------|--------------------|---|
| Sr. No.      | Feature            | Voice Command Statement   |
| In Cool Mode |                    |   |
| 1            | ON/OFF             | OK Google! Turn ON/OFF "AC name" AC   |
| 2            | Operation Mode     | OK Google! Set/Change "AC name" AC to Cool/Dry/Fan  |
| 3            | Set Temperature    | OK Google! Set Temperature to 18/19/20/.../32 on "AC name" AC   |
|              |                    | Increase/Decrease temperature by 1/2/3/.../14 on "AC name" AC   |
| 4            | Fan Speed          | OK Google! Set Fan Speed to Auto/ Indoor Unit Quiet/ Low/ Middle Low/ Middle/ Middle High/ High on "AC name" AC |
| 5            | Up & Down Swing    | OK Google! Turn ON/OFF Up-down flap on "AC name" AC   |
| 6            | Right & Left Swing | OK Google! Turn ON/OFF Left-right swing on "AC name" AC   |
| 7            | Streamer           | OK Google! Turn ON/OFF Streamer on "AC name" AC   |
| 8            | I-Eye Energy Saver | OK Google! Turn ON/OFF Energy Saver on "AC name" AC   |
| 9            | I-Eye Auto ON/OFF  | OK Google! Turn ON/OFF Auto On/Off on "AC name" AC  |
| 10           | Dew Clean          | OK Google! Turn ON/OFF Dew Clean on "AC name" AC  |
| 11           | Outdoor Quiet      | OK Google! turn ON/OFF Outdoor Quite on "AC name" AC  |
| 12           | Variable           | OK Google! Set Variable to L1/L2/L3/ L4/L5/OFF on "AC name" AC  |
| In Dry Mode  |                    |   |
| 1            | ON/OFF             | OK Google! Turn ON/OFF "AC name" AC   |
| 2            | Operation Mode     | OK Google! Set/Change "AC name" AC to Cool/Dry/Fan  |
| 3            | Up & Down Swing    | OK Google! Turn ON/OFF Up-down flap on "AC name" AC   |
| 4            | Right & Left Swing | OK Google! Turn ON/OFF Left-right swing on "AC name" AC   |
| 7            | Streamer           | OK Google! Turn ON/OFF Streamer on "AC name" AC   |
| 8            | I-Eye Energy Saver | OK Google! Turn ON/OFF Energy Saver on "AC name" AC   |
| 9            | I-Eye Auto ON/OFF  | OK Google! Turn ON/OFF Auto On/Off on "AC name" AC  |
| 10           | Dew Clean          | OK Google! Turn ON/OFF Dew Clean on "AC name" AC  |
| 11           | Variable           | OK Google! Set Variable to L1/L2/L3/ L4/L5/OFF on "AC name" AC  |

# HOW TO PROVIDE COMMAND TO GOOGLE HOME - SMART SPEAKER

| Sr. No.  | Feature   | Voice Command Statement   |
|--|---|---|
| <b>In Fan Mode</b>   |   |   |
| 1  | ON/OFF  | OK Google! Turn ON/OFF "AC name" AC   |
| 2  | Operation Mode  | OK Google! Set/Change "AC name" AC to Cool/Dry/Fan  |
| 3  | Fan Speed   | OK Google! Set Fan Speed to Auto/ Indoor Unit Quiet/ Low/ Middle Low/ Middle/ Middle High/ High on "AC name" AC |
| 4  | Up & Down Swing   | OK Google! Turn ON/OFF Up -down flap on "AC name" AC  |
| 5  | Right & Left Swing  | OK Google! Turn ON/OFF Left -right swing on "AC name" AC  |
| 8  | Streamer  | OK Google! Turn ON/OFF Streamer on "AC name" AC   |
| 9  | I-Eye Energy Saver  | OK Google! Turn ON/OFF Energy Saver on "AC name" AC   |
| 10   | I-Eye Auto ON/OFF   | OK Google! Turn ON/OFF Auto On/Off on "AC name" AC  |
| 11   | Dew Clean   | OK Google! Turn ON/OFF Dew Clean on "AC name" AC  |
| <b>Status Commands</b>   |   |   |
| 1  | ON/OFF  | OK Google! Is the "AC name" AC Turned ON?   |
| 1  | Operation Mode  | OK Google! Which Mode is the "AC name" AC set to?   |
| 2  | Set Temperature<br>(Not applicable in Dry Mode and Fan Mode)        | OK Google! What is the current Set Temperature on "AC name" AC?   |
| 3  | Fan Speed<br>(Not applicable in Dry Mode and Power Chill operation) | OK Google! What is the current Fan Speed in "AC name" AC?   |
| 4  | Up & Down Swing   | OK Google! What is the current status of Up -down flap on "AC name" AC  |
| 5  | Right & Left Swing  | OK Google! What is the status of Left -right flap on "AC name" AC   |
| 6  | Streamer  | OK Google! What is the current status of Streamer "AC name" AC  |
| 7  | I-Eye Energy Saver  | OK Google! What is the current status of Energy Saver on "AC name" AC   |
| 8  | I-Eye Auto ON/OFF   | OK Google! What is the current status of Auto On/Off on "AC name" AC  |
| 9  | Dew Clean   | OK Google! What is the current status of Dew clean on "AC name" AC  |
| 10   | Outdoor Quiet<br>(Not applicable in Dry Mode and Fan Mode)          | OK Google! What is the current status of Outdoor Quiet on "AC name" AC  |
| <p>Note: 1. If AC name is set to 'Bedroom' then command will be<br/>→ OK Google! Turn ON Bedroom <b>AC</b></p> <p>2. Voice commands other than the above mentioned voice commands may not work properly.</p> <p>3. If Smart Speaker doesn't respond, Please re-check the above setup process or internet connection.</p> |   |   |

**PROTECT THE ENVIRONMENT FROM E-WASTE ( GUIDELINES)**

Meaning of E-waste under E-Waste (Management) Rules,2022 (E-waste Rules)  
-Waste electrical and electronic equipment, whole or in part of reject from their manufacturing and repair process, which are intended to be discarded.

Our product is RoHS compliant.

**Don't dump Electrical and Electronic Products in Garbage Bins****DO'S & DONT'S**

| <b>DO'S</b>  |   |
|--|---|
| Run and maintain the air conditioner as per the instructions given in the operation / instruction manual         | ✓ |
| Ensure that an authorised person repairs your air conditioner  | ✓ |
| Call our local authorised dealer or our toll free number to dispose your air conditioner                         | ✓ |
| Contact an authorised dealer in case of installation or de-installation  | ✓ |
| Consult our local authorised dealer or our toll free number on the life span of the air conditioner              | ✓ |
| <b>DONT'S</b>  |   |
| Do not try to repair your air conditioner on your own  | X |
| Do not sell or dispose your air conditioner or parts to an unauthorised Kabbadi wala / Scrap Dealer / Ragpickers | X |
| Do not dismantle your air conditioner on your own  | X |
| Do not get your air conditioner or any parts repaired by an unauthorised person                                  | X |
| Do not dispose off the E-waste in landfills  | X |
| Do not use the air conditioner as furniture after its use  | X |

**Customer Contact Center : 011-4031 9300/1860-180-3900**

**For further information visit us at [www.daikinindia.com](http://www.daikinindia.com)**



# WIRING DIAGRAM

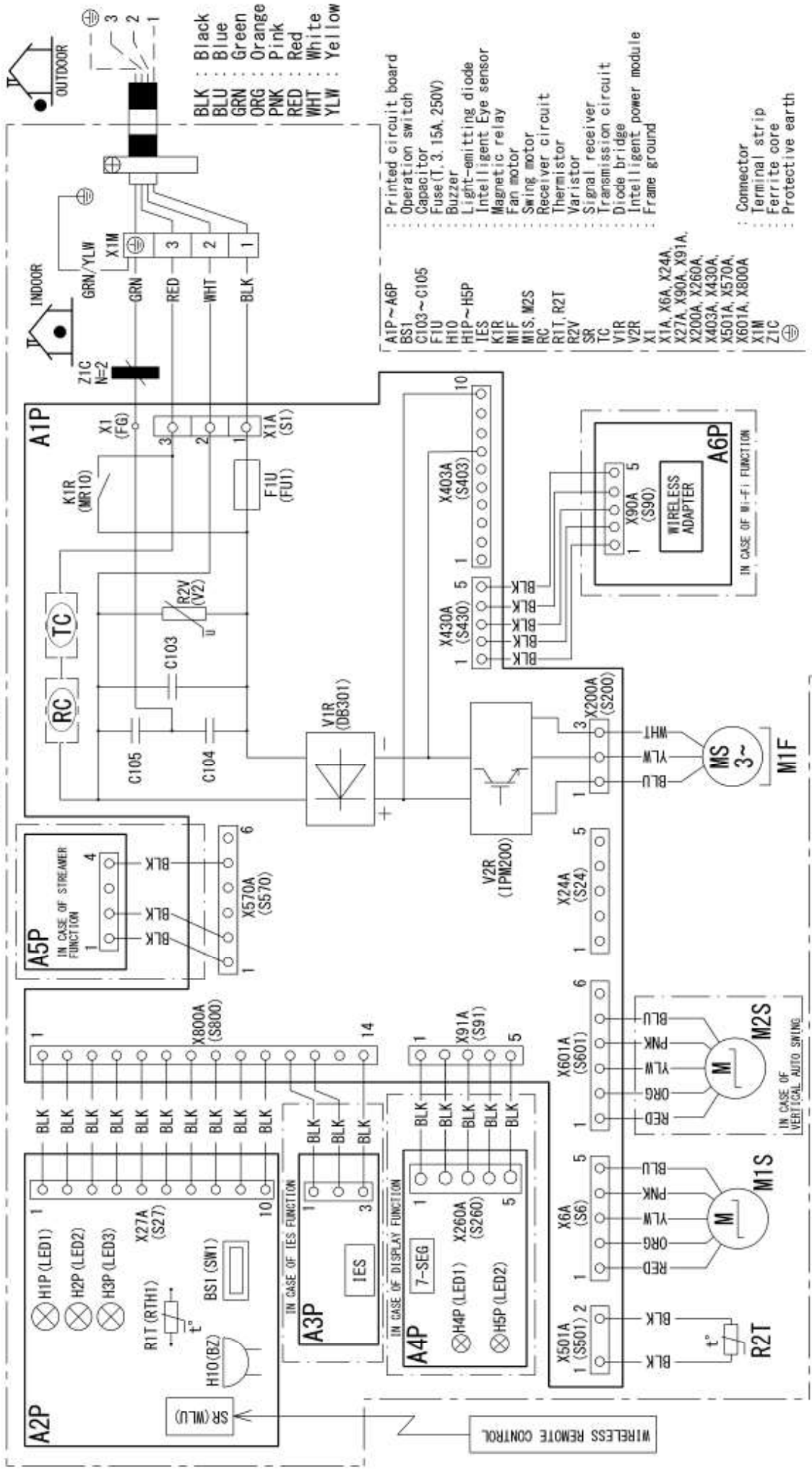

CAUTION: WHEN THE MAIN POWER IS TURNED OFF AND THEN BACK ON AGAIN, OPERATION WILL RESUME AUTOMATICALLY.

3D145284-1A

Applicable Model - JTKJ35UV16WA, JTKJ50UV16VA, JTKJ60UV16UA, BRP35605AR1V1, BRP50605AR1V1, BRP60605AR1V1, FTKN35UV16WA, FTKN50UV16VA

# WIRING DIAGRAM

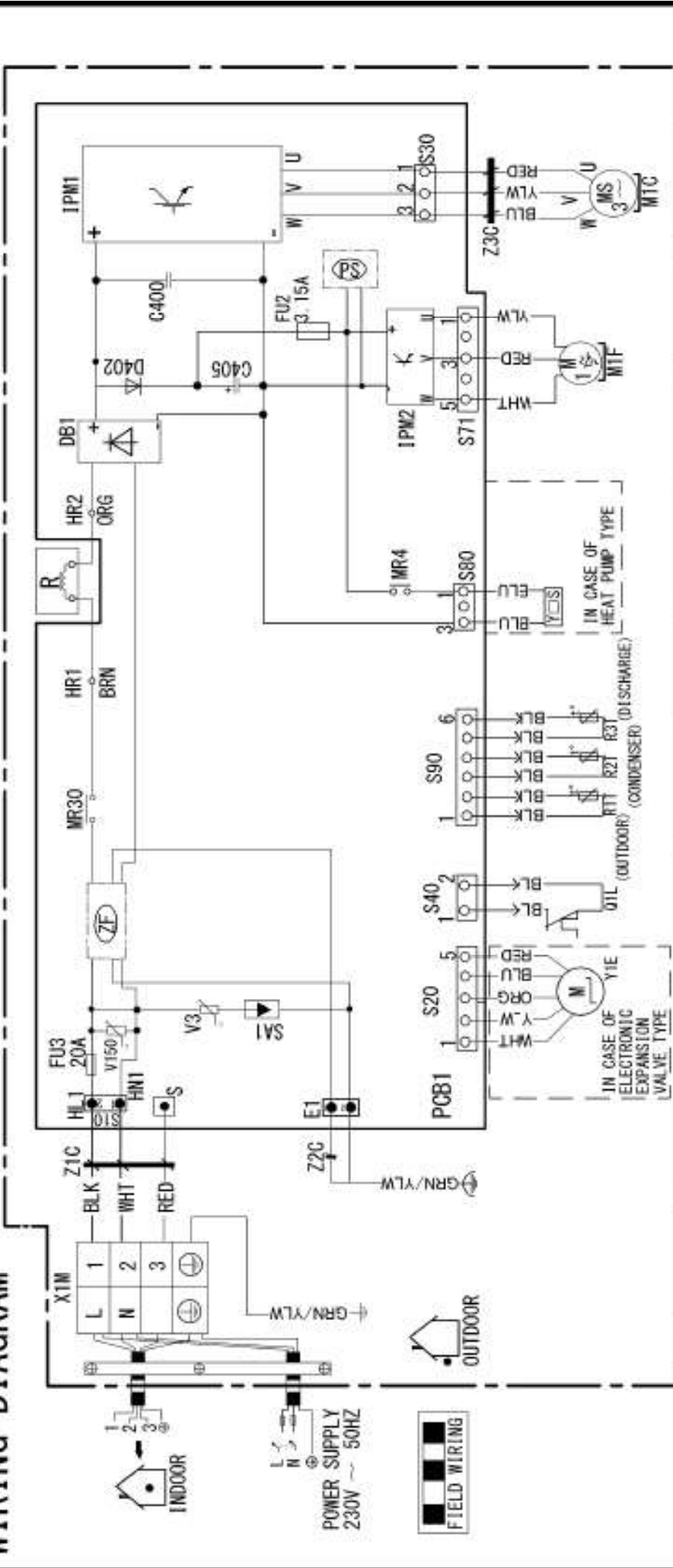

**NOTE**  
 1. REFER TO THE NAME PLATE FOR THE POWER REQUIREMENTS.

**COMPONENTS:**  
 CAPACITOR: C400, C405  
 DIODE BRIDGE: DB1  
 DIODE: D402  
 FUSE: FU2, FU3  
 HEAT PUMP RELAY: HR1, HR2  
 INTELLECTUAL POWER MODULE: 1PW1, 1PW2  
 LINE: L  
 FAN MOTOR: M1F  
 MAGNETIC RELAY: MR30, MR4  
 COMPRESSOR MOTOR: M1C  
 NEUTRAL: N

**FIELD WIRING:** (Legend with black and white squares)

**LEGEND:**  
 PCB1: PRINTED CIRCUIT BOARD  
 PS: SWITCHING POWER SUPPLY  
 QIL: OVERLOAD PROTECTOR  
 R1T, R2T, R3T: THERMISTOR  
 R: REACTOR  
 SA1: SURGE ARRESTOR  
 S20, S10, S30: CONNECTOR  
 S40, S71, S80: VARIATOR  
 S90, E1: VARIATOR  
 V150, V3: VARIATOR

**TERMINAL STRIP:**  
 X1M: TERMINAL STRIP  
 Y1E: ELECTRONIC EXPANSION VALVE COIL  
 Y2S: REVERSING SOLENOID VALVE COIL  
 Z1C, Z2C, Z3C: FERRITE CORE  
 ZF: NOISE FILTER  
 ⊕: PROTECTIVE EARTH  
 ⊥: EARTH  
 ⊕: NOISELESS EARTH

**3D125941-1**

Applicable Model - RKJ35UV16W



# WIRING DIAGRAM

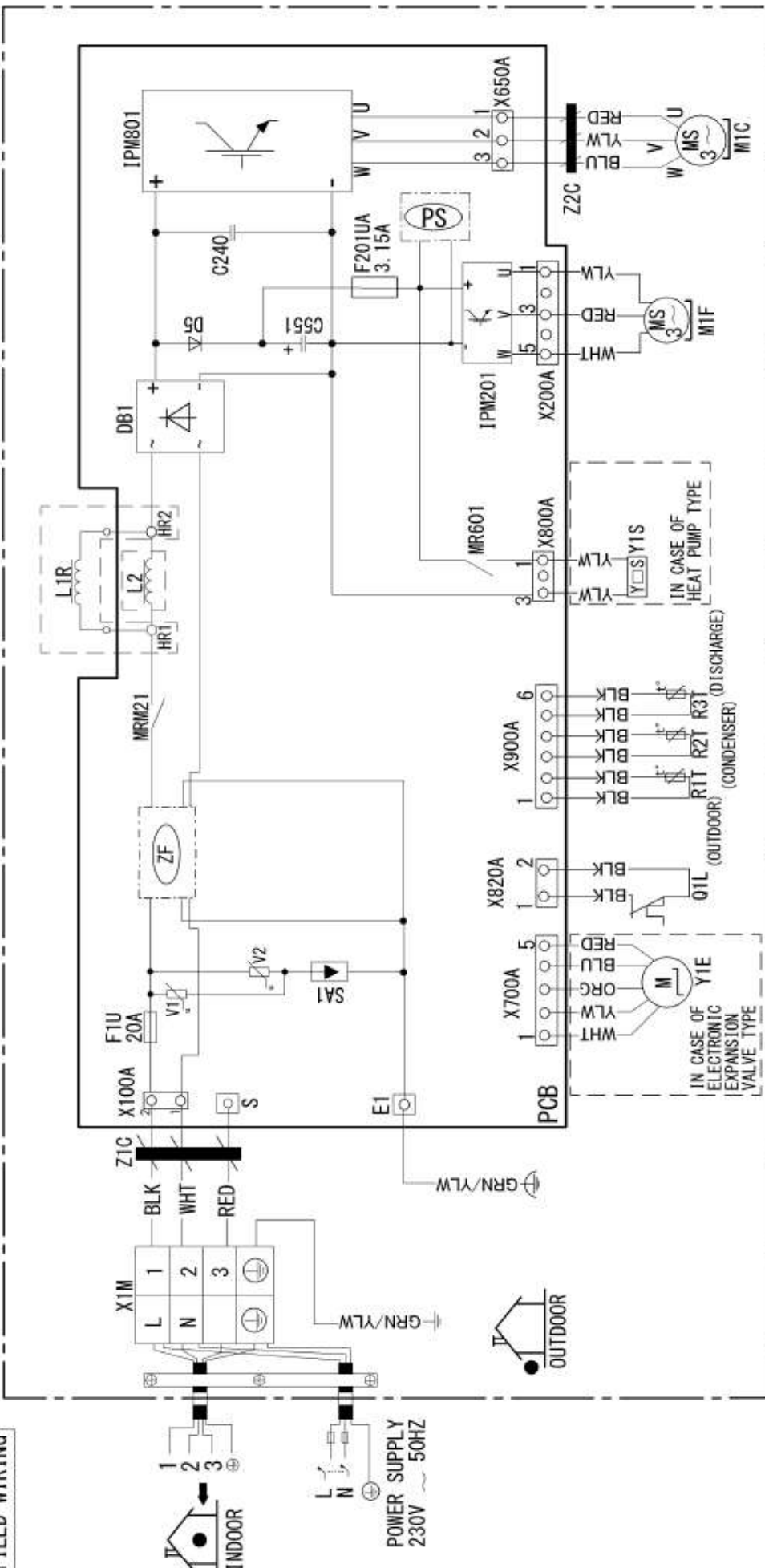

- NOTE**  
1. REFER TO THE NAME PLATE FOR THE POWER REQUIREMENTS.
- ... CAPACITOR
  - ... DIODE BRIDGE
  - ... DIODE
  - ... FUSE
  - ... INTELLIGENT POWER MODULE
  - ... LINE
  - ... IN CASE OF ON-BOARD REACTOR
  - ... IN CASE OF OUTSIDE REACTOR
- ... COMPRESSOR MOTOR
  - ... MAGNETIC RELAY
  - ... FAN MOTOR
  - ... NEUTRAL
  - ... PRINTED CIRCUIT BOARD
  - ... SWITCHING POWER SUPPLY
  - ... OVERLOAD PROTECTOR
  - ... THERMISTOR
  - ... SURGE ARRESTOR
  - ... CONNECTOR
- ... VARIATOR
  - ... TERMINAL STRIP
  - ... ELECTRONIC EXPANSION VALVE COIL
  - ... REVERSING SOLENOID VALVE COIL
  - ... FERRITE CORE
  - ... NOISE FILTER
  - ... PROTECTIVE EARTH
  - ... EARTH
  - ... NOISELESS EARTH
- V1, V2
  - X1M
  - Y1E
  - Y1S
  - Z1C, Z2C
  - ZF

3D146912-1

Applicable Model - RKJ50UV16V

# WIRING DIAGRAM

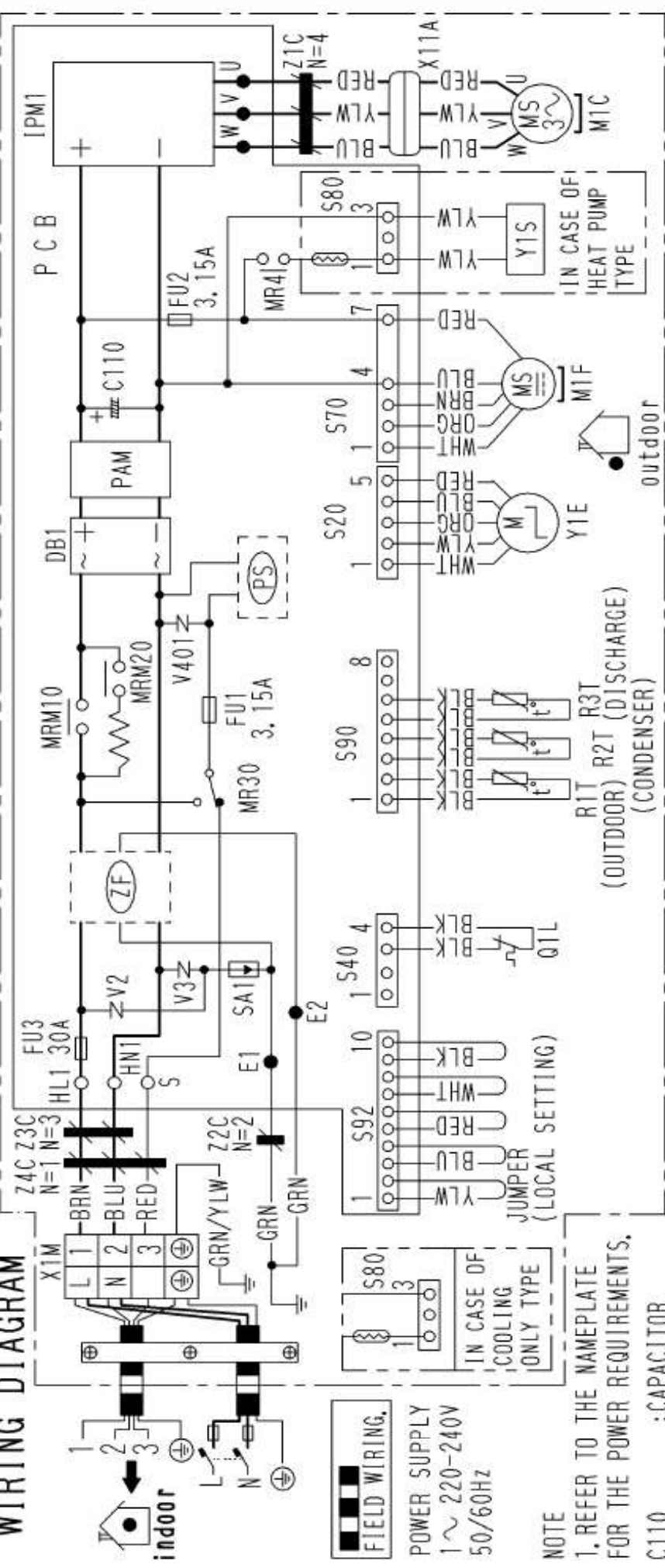

**FIELD WIRING.**

POWER SUPPLY  
1 ~ 220-240V  
50/60Hz

**NOTE**  
1. REFER TO THE NAMEPLATE FOR THE POWER REQUIREMENTS.

- C110 : CAPACITOR
- DB1 : DIODE BRIDGE
- FU1, FU2, FU3: FUSE
- IPM1 : INTELLIGENT POWER MODULE
- L : LINE
- M1C : COMPRESSOR MOTOR
- M1F : FAN MOTOR
- MR4, MR30, MRM10, MRM20: MAGNETIC RELAY
- N : NEUTRAL
- S80 : CAPACITOR
- S92 : JUMPER (LOCAL SETTING)
- S90 : R1T, R2T, R3T: THERMISTOR (CONDENSER)
- S70 : Y1E (OUTDOOR)
- S20 : M (INDOOR)
- SA1 : SURGE ARRESTER
- V2, V3, V401 : VARIATOR
- X1M : SWITCHING POWER SUPPLY
- Y1E : OVERLOAD PROTECTOR
- Y15 : ELECTRONIC EXPANSION VALVE COIL
- Z1C, Z2C, Z3C, Z4C: FERRITE CORE
- ZF : NOISE FILTER
- ⊕ : PROTECTIVE EARTH
- ⚡ : EARTH

Applicable Model - RKJ60UV16U

3D130856-1