

DAIKIN ROOM AIR CONDITIONER

OPERATION MANUAL

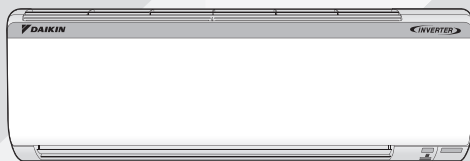

MODELS:

F/G/MTKM50UV16V

A/D/F/G/MTKL50UV16VA

A/D/F/G/MTKL50UV16VAF

F/GTKC50UV16V

FTKC50UV16VF

F/MTKC42UV16V

Safety Precautions

- Keep this manual where the user can easily find it.
- Read the precautions in this manual carefully before operating the unit.
- The precautions described herein are classified as **WARNING** and **CAUTION**. They both contain important information regarding safety. Be sure to observe all precautions without fail.

WARNING

Failure to follow these instructions properly may result in personal injury or loss of life.

CAUTION

Failure to follow these instructions properly may result in property damage or personal injury, which may be serious depending on the circumstances.



Never attempt.



Be sure to follow the instructions.



Be sure to establish an earth connection.

- After reading, keep this manual in a convenient place so that you can refer to it whenever necessary. If the equipment is transferred to a new user, be sure also to hand over the manual.

WARNING



- To avoid fire, explosion or injury, do not operate the unit when harmful gases (e.g. flammable or corrosive) are detected near the unit. 
- Be aware that prolonged, direct exposure to cool air from the air conditioner, or to air that is too cool, can be harmful to your physical condition and health.
- Do not place objects, including rods, your fingers, etc., in the air inlet or outlet. Product damage may result due to contact with the air conditioner's high-speed fan blades.
- Do not attempt to repair, dismantle, reinstall or modify the air conditioner yourself as this may result in water leakage, electric shock or fire hazards.
- Do not use flammable spray near the air conditioner, or otherwise fire may result.
- Do not use a refrigerant other than the one indicated on the outdoor unit (R32) when installing, moving or repairing. Using other refrigerants may cause trouble or damage to the unit, and personal injury.
- To avoid electric shock, do not operate with wet hands.

- Beware of fire in case of refrigerant leakage. If the air conditioner is not operating correctly, i.e. not generating cool air, refrigerant leakage could be the cause. Consult your service centre for assistance. The refrigerant within the air conditioner is safe and normally does not leak. However, in the event of a leakage, contact with a naked burner, heater or cooker may result in generation of noxious gas. Do not use the air conditioner until a qualified service person confirms that the leakage has been repaired. 

- Do not attempt to install or repair the air conditioner yourself. Improper workmanship may result in water leakage, electric shock or fire hazards. Please contact your local service centre or qualified personnel for installation and maintenance work.
- If the air conditioner is malfunctioning (giving off a burning odour, etc.), turn off power to the unit and contact your local service centre. Continued operation under such circumstances may result in a failure, electric shock or fire hazards.
- Be sure to install an earth leakage circuit breaker. Failure to install the earth leakage circuit breaker may result in electric shock or fire.

- Be sure to earth the unit. Do not earth the unit to a utility pipe, lightning conductor or telephone earth lead.  Imperfect earthing may result in electric shock.

CAUTION

- Do not use the air conditioner for purposes other than those for which it is intended. Do not use the air conditioner for cooling precision instruments, food, plants, animals or works of art as this may adversely affect the performance, quality and/or longevity of the object concerned. 
 - Do not expose plants or animals directly to the airflow from the unit as this may cause adverse effects.
 - Do not place appliances that produce naked flames in places exposed to the airflow from the unit as this may impair combustion of the burner.
 - Do not block the air inlets or outlets. Impaired airflow may result in insufficient performance or trouble.
 - Do not sit on the outdoor unit, put things on the unit, or pull the unit. Doing so may cause accidents, such as falling or toppling down, thus resulting in injury, product malfunctioning, or product damage.
 - Do not place objects that are susceptible to moisture directly beneath the indoor or outdoor units. Under certain conditions, condensation on the main unit or refrigerant pipes, air filter dirt or drain blockage may cause dripping, resulting in fouling or fire of the object concerned.
 - After prolonged use, check the unit stand and its mounts for damage. If they are left in a damaged condition, the unit may fall and cause injury.
 - To avoid injury, do not touch the air inlet or aluminium fins of the indoor or outdoor units.
 - The appliance is not intended for use by unattended young children or infirm persons. Impairment of bodily functions and harm to health may result.
 - Children should be supervised to ensure that they do not play with the unit or its remote controller. Accidental operation by a child may result in impairment of bodily functions and harm health.
 - Avoid impacts to the indoor and outdoor units, or otherwise product damage may result.
 - Do not place flammable items, such as spray cans, within 1m of the air outlet. The spray cans may explode as a result of hot air from the indoor or outdoor units.
 - Be careful not to let pets urinate on the air conditioner. Urination on the air conditioner may result in electric shock or fire.
 - Do not wash the air conditioner with water, as this may result in electric shock or fire.
 - Do not place water containers (vases, etc.) above the unit, as this may result in electric shock or fire hazards if they should topple over.
 - Do not insert the batteries in the wrong polarity (+/-) orientation as this may result in short circuiting, fire, or battery leakage.
-
- To avoid oxygen depletion, ensure that the room is adequately ventilated if equipment such as a burner is used together with the air conditioner. 
 - Before cleaning, be sure to stop unit operation and turn off the circuit breaker. Otherwise, an electric shock and injury may result.
 - Only connect the air conditioner to the specified power supply circuit. Power supplies other than the one specified may result in electric shock, overheating and fires.
 - Arrange the drain hose to ensure smooth drainage. Imperfect drainage may cause wetting of the building, furniture, etc.
 - Do not place objects in direct proximity of the outdoor unit and do not let leaves and other debris accumulate around the unit. Leaves are a hotbed for small animals which can enter the unit. Once inside the unit, such animals can cause malfunctions, smoke or fire if they come into contact with electrical parts.
 - Do not place objects around the indoor unit. Doing so may have an adverse influence on the performance, product quality, and life of the air conditioner.
 - This appliance is not intended to be used by persons with reduced physical, sensory or mental capabilities, or with lack of operation knowledge, unless they have been given supervision or instruction concerning the appliance use by person responsible for their safety. Keep out of children's reach to ensure that they do not play with the appliance.

Name of Parts

■ Indoor Unit

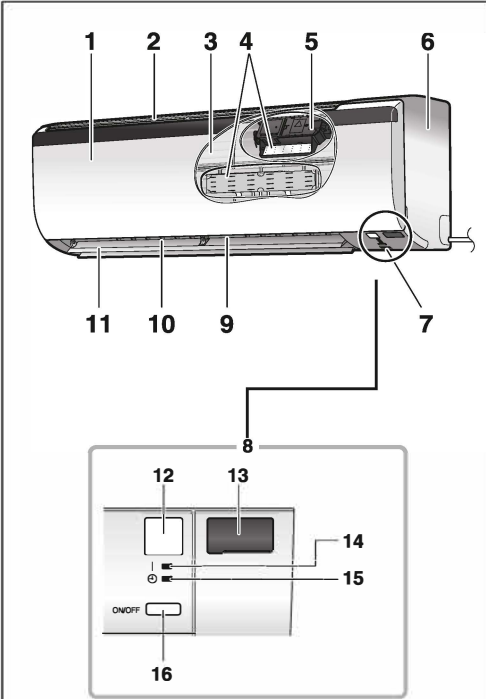

1. Front panel
2. Air inlet
3. Air filter
4. Accessory filter*
5. Streamer unit*
6. Model name plate
7. Indoor temperature sensor:
 - Detects the air temperature around the unit.
8. Display
9. Air outlet
10. Louvres (vertical blades):*
 - The louvres are inside of the air outlet.
11. Flaps (horizontal blades)
12. Signal receiver:
 - Receives signals from the remote controller.
 - When the unit receives a signal, you will hear a beep sound.

Case	Sound type
Operation start	beep-beep
Settings changed	beep
Operation stop	long beep

13. Inverter output and temperature display*
14. OPERATION lamp (green)
15. TIMER lamp (orange)
16. Indoor unit ON/OFF switch:

- Press this switch once to start operation. Press once again to stop it.
- For the operation mode setting, refer to the following table.

Mode	Temperature setting	Airflow rate
COOL	22°C	AUTO

- This switch can be used when the remote controller is missing.

■ Outdoor Unit

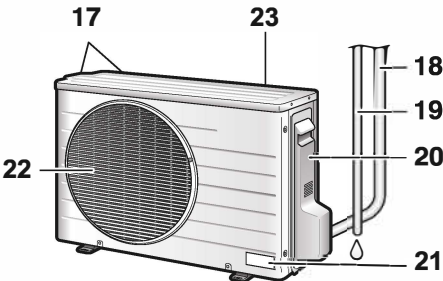

Appearance of the indoor/outdoor unit may differ between different models.

17. Air inlet (back and side)
18. Refrigerant pipes and inter-unit wire
19. Drain hose
20. Earth terminal (inside)
21. Model name plate
22. Air outlet
23. Outdoor temperature sensor (back)

* Features available with selected models

Name of Parts

Remote Controller

1. Signal transmitter:

- Send signals to the indoor unit.

2. Display (LCD):

- Displays the current setting.
(In this illustration, each section is shown with its display on for the purpose of explanation.)

3. ON/OFF button:

- Press this button once to start operation.
Press once again to stop it.

4. TEMPERATURE adjustment button:

- Changes the temperature setting.

5. FAN setting button:

- Selects the airflow rate setting.

6. SWING button:

- Adjusts the airflow direction.

7. POWER CHILL button:

- POWER CHILL operation.

8. MODE selector button:

- Selects the operation mode.
(DRY/COOL/FAN)

9. ECONO button:

- ECONO operation.

10. COANDA/STREAMER button:

- COANDA/STREAMER operation.

11. TIMER CANCEL button:

- Cancels the timer setting.

12. ON TIMER button

13. OFF TIMER button

14. GOOD SLEEP/DISPLAY button

15. DEW CLEAN button

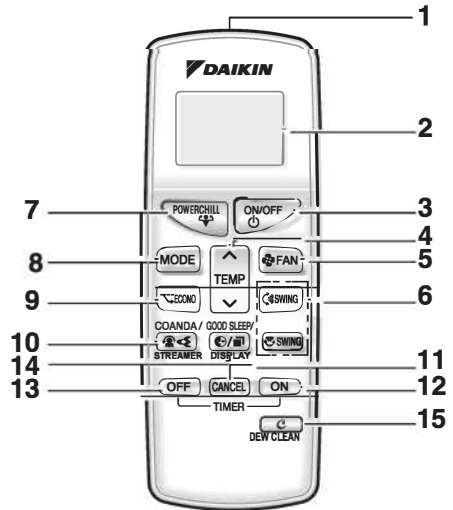

S.NO	MODEL NO.	REMOTE NO.
1	F/MTKM50UV16V	ARC48432
2	A/D/F/MTKL50UV16VA	
3	GTKM50UV16V	ARC484B33
4	GTKL50UV16VA	
5	A/D/F/MTKL50UV16VAF	ARC484B32
6	GTKL50UV16VAF	ARC484B33
7	F/GTKC50UV16V	ARC484B67
8	FTKC50UV16VF	
9	F/MTKC42UV16V	

NOTE

Notes on remote controller

- Never expose the remote controller to direct sunlight.
- Dust on the signal transmitter or receiver will reduce the sensitivity. Wipe off dust with soft cloth.
- Signal communication may be disabled if an electronic-starter-type fluorescent lamp (such as inverter-type lamp) is in the room. Consult your service centre if that is the case.
- If the remote controller activates other electric devices, move them away or consult your service centre.
- Remote appearance may vary as per applicable model.

Preparation before Operation

⚠ CAUTION

Incorrect handling of batteries can result in injury from battery leakage, rupturing or heating, or lead to equipment failure. Please observe the following precautions and use safely.

- If the solution from the batteries should get in the eyes, do not rub the eyes. Instead, immediately flush the eyes with tap water and seek the attention of a medical professional.
- Keep batteries out of reach of children. In the event that batteries are swallowed, seek the immediate attention of a medical professional.
- Do not expose batteries to heat or fire. Do not disassemble or modify batteries. The insulation or gas release vent inside the battery may be damaged, resulting in battery leakage, rupturing, or heating.
- Do not damage or peel off labels on the batteries.

■ To insert the batteries

1. Remove the back cover by sliding and then slightly lifting it.
2. Insert 2 dry batteries (AAA).
3. Replace the back cover.

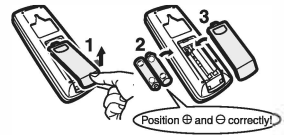

■ To operate the remote controller

- To use the remote controller, aim the transmitter at the indoor unit. If there is anything blocking the signals between the unit and the remote controller, such as a curtain, the unit will not operate.
- Do not drop the remote controller. Do not get it wet.
- The maximum transmission distance is about 7m.

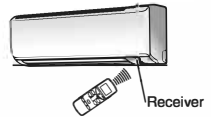

■ To attach the accessory filters

- Set the accessory filters under the tabs of the filter frame on the indoor/streamer unit.
- When attaching the accessory filters, refer to “Care and Cleaning”, and pull out the air filters.

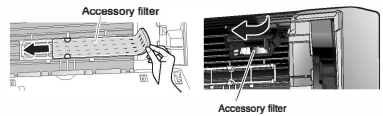

■ Turn on the circuit breaker

- After the power is turned on, the flaps of the indoor unit open and close once to set the reference position.

NOTE

■ Tips for saving energy

- Be careful not to cool the room too much. Keeping the temperature setting at a moderate level helps save energy.
- Cover windows with a blind or a curtain. Blocking sunlight and air from outdoors increases the cooling effect.
- Clogged air filters cause inefficient operation and waste energy. Clean them once in about every 2 weeks.

■ Notes on batteries

- Do not use a leaking battery.
- To avoid possible injury or damage from battery leakage or rupturing, remove the batteries when not using the product for long periods of time.
- The standard replacement time is about 1 year. Both batteries should be replaced at the same time. Be sure to replace them with new size AAA dry batteries. However, if the remote controller display begins to fade and the possible transmission range becomes shorter within a year, replace both batteries as specified above.
- If the batteries supplied with the remote controller are for initial operation. The batteries may run out in less than 1 year.

DRY. COOL. FAN / STREAMER Operation

The air conditioner operates with the operation mode of your choice.

From the next time on, the air conditioner will operate with the same operation mode.

■ To start operation

1. Press  and select an operation mode. • Each pressing of the button changes the mode setting in sequence.



2. Press . • “ON” is displayed on the LCD and The OPERATION lamp lights green.



■ To stop operation

3. Press  again. • “ON” disappears from the LCD and Then OPERATION lamp goes off.

■ To change the temperature setting

4. Press . • Press  to raise the temperature and press  to lower the temperature.

COOL operation	DRY or FAN operation
18-32°C	The temperature setting cannot be changed.

Default Set Temperature Setting : As per BEE regulation, whenever Air Conditioner will be switched ON from the remote, the default set temperature will be set as mentioned in below table:

Mode	Set temperature before remote switched OFF	Set temperature after remote switched ON
Cool	If set temperature < 24°C	Default set temperature will be 24°C.
	If set temperature >= 24°C	Default set temperature will remain same as set prior to remote switched OFF.

Note:

Whenever AC is switched OFF in dry mode and is switched ON from remote, air conditioner will start in Cool mode and then DRY mode selection can be done using the MODE button.

STREAMER Operation

The absorption power of the accessory filter and the decomposition power of the streamer discharge combine to reduce unpleasant odours and viruses, cleaning the air in the room.

1. Press .

When long press(duration defined ≥ 5 sec) the “COANDA / STREAMER”KEY, then STREAMER function will be enabled and respective symbol glow on remote LCD.

1. Press .

Again long press(duration defined ≥ 5 sec) the “COANDA/STREAMER”KEY, then STREAMER will be get disabled and respective STREAMER symbol disappeared from remote LCD.

NOTE



- **Note on COOL operation**
 - This air conditioner cools the room by releasing heat in the room outdoors. Therefore, cooling performance may fall in higher outdoor temperatures.
- **Note on DRY operation**
 - Eliminates humidity while maintaining the indoor temperature as much as possible. It automatically controls temperature and airflow rate, so manual adjustment of these function is unavailable.
- **Note on FAN operation**
 - This mode is valid for fan only.
- **Note on FAN operation**
 - For cooling: 26-28°C
- **What is streamer discharge?**
 - This is a type of plasma discharge comprising high-speed electrons with a high oxidative capacity that is released within the unit. It decomposes odours and harmful gases.
(The high-speed electrons are generated and then adsorbed within the unit to ensure your safety.)
 - The streamer discharge may generate a hissing sound, however, this does not indicate a defect.
- **Note on FLASH STREAMER AIR PURIFYING operation**
 - When airflow is weak during operation, the streamer discharge may stop temporarily to prevent the emission of trace amounts of ozone from the air outlet.

Adjusting the Airflow Rate/SMELL PROOF/CHILD LOCK Operation

Adjusting the airflow rate

You can adjust the airflow rate to increase your comfort.

To change the airflow rate setting

Press  . • Each pressing of  changes the airflow rate setting in sequence.

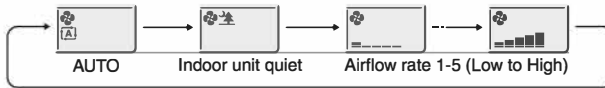

- In DRY operation, the airflow rate setting cannot be changed.
- When the airflow is set to “”, quiet operation starts and noise from the indoor unit will become quieter.
- In the quiet operation mode, the airflow rate is set to a weak level.

SMELL PROOF operation

The SMELL PROOF operation prevents unpleasant odour inside the indoor unit. This function is available in both DRY and COOL operation.

To use SMELL PROOF operation

1. Before starting the operation, press  to set to Auto.
2. Press  to select the DRY or COOL operation.
3. Press  . Air starts circulating about 1 minute after the operation is started. However, if the POWER CHILL operation is started, air starts circulating immediately.

CHILD LOCK operation

Setting the CHILD LOCK disables all the buttons except when **ECONO** and **POWERFULL** button press together for about 5 seconds.

□ To set the CHILD LOCK :

- Press  and  together for about 5 seconds.

• “” will be displayed on the remote LCD. • If a button is pressed while CHILD LOCK is on, “” blinks.

□ To CANCEL the CHILD LOCK

Press  and  together for about 5 seconds again.

“” Disappears from the LCD.

NOTE

Note on airflow rate setting

- At smaller airflow rates, the cooling effect is also smaller.

Note on SMELL PROOF operation

- SMELL PROOF operation can prevent some odours, but not all.

Notes on the operating conditions

- The air conditioner always consumes a small amount of electricity even while it is not operating.
- If you are not going to use the air conditioner for a long period, turn off the circuit breaker.
- Operation outside the humidity or temperature range described in the table may cause a safety device to disable the system.

Mode	Operating conditions	If operation is continued out of this range
COOL	Outdoor temperature: 20-(52~54°C)* Indoor temperature: 18-32°C Max. temperature varying model to model.	• A safety device may activate to stop the operation. • Dew may form on the indoor unit and drip from it when COOL or DRY operation is selected.
DRY	Indoor humidity: 80% max.	

Adjusting the Airflow Direction

You can adjust the airflow direction to increase your comfort.

⚠ CAUTION

- Always use a remote controller to adjust the angles of the flaps. Moving the flaps forcibly by hand may cause a malfunction.
- Be careful when adjusting the louvres. Inside the air outlet, a fan is rotating at a high speed.

■ To start auto swing

Upper and lower airflow direction

1. Press  .

- “” is displayed on the LCD.
- The flap (horizontal blade) will begin to swing.

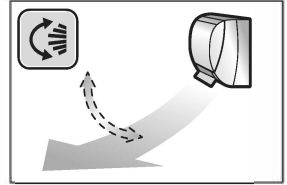

Right and left airflow direction



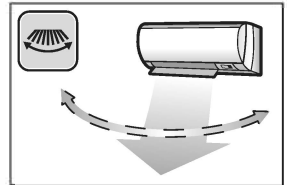

1. Press  .

- “” is displayed on the LCD.
- The louvres (vertical blades) will begin to swing.



The 3-D airflow direction

1. Press  and  .

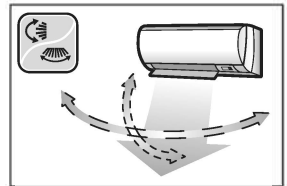

- “” and “” are displayed on the LCD.
- The flap and louvres move in turn.
- To cancel 3-D airflow, press either  or  again. The flap or louvres will stop moving.



■ To set the flap or louvres at desired position

- This function is effective while flap or louvres are in auto swing mode.

1. Press  and  when the flap or louvres have reached the desired position.

- In the 3-D airflow, the flap and louvres move in turn.
- “” or “” disappears from the LCD.

■ Note on 3-D airflow



- Using 3-D airflow circulates cold air, which tends to collect at the bottom of the room, and hot air, which tends to collect near the ceiling, throughout the room, preventing areas of cold and hot developing.

COANDA/POWER CHILL & ECONO Operations



COANDA Operation

Directs airflow upward. This function prevents air from blowing directly at users.

■ To start COANDA operation

1. Press  The flaps position will change, preventing air from blowing directly on the occupants of the room.
- “” is displayed on the LCD. The flap will go up.



■ To cancel COANDA operation

2. Press  again.
 - The flaps will return to memory position from COANDA mode.
 - “” disappears from the LCD

POWER CHILL Operation

POWER CHILL operation quickly maximises the cooling effect in any operation mode. In this mode, the air conditioner operates at maximum capacity.

■ To Start POWER CHILL operation

1. Press 
 - POWER CHILL operation ends in 20 minutes. Then the system automatically operates again with the previous settings which were used before POWER CHILL operation.
 - “” is displayed on the LCD.

■ To cancel POWER CHILL operation

2. Press  again.
 - “” disappears from the LCD.

NOTE

■ Notes on COANDA operation

- The flaps position will change, preventing air from blowing directly on the occupants of the room.
- If the up and down airflow direction is selected, the COANDA operation will be cancelled.
- The airflow rate can be set to any level. However, a low airflow rate may result in the downward flow of cold air, and in air blowing at people.

■ Notes on POWER CHILL operation

- When using POWER CHILL operation, there are some functions which are not available.
- POWER CHILL operation can only be set when the unit is running.
- POWER CHILL operation will not increase the capacity of the air conditioner if the air conditioner is already in operation with its maximum capacity demonstrated.

■ In COOL operation

To maximise the cooling effect, the capacity of outdoor unit is increased and the airflow rate becomes fixed at the maximum setting. The temperature and airflow settings cannot be changed.

■ In DRY operation

The temperature setting is lowered by 2.5°C and the airflow rate is slightly increased.

■ In FAN operation

The airflow rate is fixed at the maximum setting.

ECONO Operation

ECONO operation enables efficient operation by limiting the maximum power consumption. This function is useful to prevent the circuit breaker from tripping when the unit operates alongside other appliances on the same circuit.

■ To start ECONO operation

1. Press  during operation.



- “” is displayed on the LCD.

■ To cancel ECONO operation

2. Press  again.

- “” disappears from the LCD.

■ Notes on ECONO operation

- ECONO operation can only be set when the unit is running. Pressing  causes the settings to be cancelled, and “” disappears from the LCD.
- ECONO operation functions in COOL and DRY operation.
- POWER CHILL and ECONO operation cannot be used at the same time. Priority is given to the function of whichever button is pressed last.
- This operation is performed with lower power and therefore may not provide a sufficient cooling effect.

TIMER/GOOD SLEEP Operation

TIMER Operation

Timer functions are useful for automatically switching the air conditioner on or off in the morning or at night. You can also use the ON TIMER and GOOD SLEEP OFF TIMER together.

To use ON TIMER operation

1. Press **ON** .

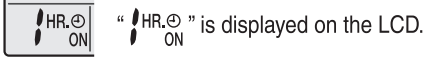

Each pressing of **ON** changes the time setting by 1 hour.

The time can be set between 1 and 12 hours.

- The TIMER lamp lights orange.



To use OFF TIMER operation

1. Press **OFF** .

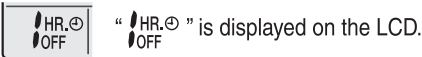

Each pressing of **OFF** changes the time setting by 1 hour.

The time can be set between 1 and 9 hours.

- The TIMER lamp lights orange.



To cancel TIMER operation

2. Press **CANCEL** .

- “HR. OFF” disappears from the LCD.
- The TIMER lamp goes off.

To combine ON TIMER and GOOD SLEEP OFF TIMER

- A sample setting for combining the 2 timers is shown below.
- “ON” and “OFF” are displayed on the LCD.



NOTE

Note on TIMER operation

- Once you set ON / GOOD SLEEP OFF TIMER, the time setting is kept in the memory. The memory is cleared when the remote controller batteries are replaced.

GOOD SLEEP Operations

To use GOOD SLEEP OFF TIMER operation.

1. Press **GOOD SLEEP** during COOL operation.

- “ °C ” blinks for a few seconds.
- The temperature shift value (default: 2) is displayed on the LCD for a few seconds.
- “ °C ”, “OFF” and the stop time (default: 2HR.) are displayed on the LCD.
- The TIMER lamp lights orange.

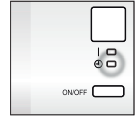

Display

2. Press **TEMP** while “°C” is blinking.

- Each pressing of the button changes temperature shift value by 1°C.

You can specify a temperature shift value between +1°C and +5°C.

3. Press **GOOD SLEEP** while “°C” is blinking.

- Each pressing of the button changes the time setting.

The time can be set between 1 and 9 hours.

1 hour...→ 9 hours → OFF

To cancel GOOD SLEEP OFF TIMER operation

1. Press **CANCEL**

- “ °C ”, “OFF” and the stop time indication disappear from the LCD.
- The TIMER lamp goes off.

NOTE

Notes on GOODSLEEP TIMER operation

- The set temperature increases by 0.5°C in 30 minutes until the total increase reaches the specified shift value. There is no function for heating the room.

EXAMPLE

Temperature shift value at +2°C, OFF TIMER at 8 hours ———
 Temperature shift value at +5°C, OFF TIMER at 8 hours - - - - -

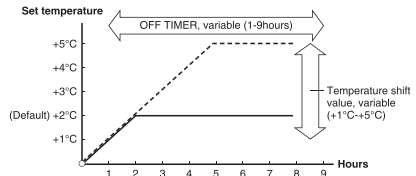

In the following cases, set the timer again.

- After the circuit breaker has turned off.
- After a power failure.
- After replacing the batteries in the remote controller.

Checking the Inverter Output and Temperature Display

- When “Good Sleep/Display” key of remote controller push down and hold it for ≥ 2 second then “DISPLAY” IR Signal will be transmitted.
- The inverter output and temperature display for the indoor unit shows the current inverter output, indoor temperature, and set temperature.

■ Checking current inverter output, indoor temperature and set temperature when air conditioner is in operation

1. Press for ≥ 2 seconds during operation

- Each press of  for ≥ 2 seconds, Cycles the display through current inverter output, indoor temperature, and set temperature.

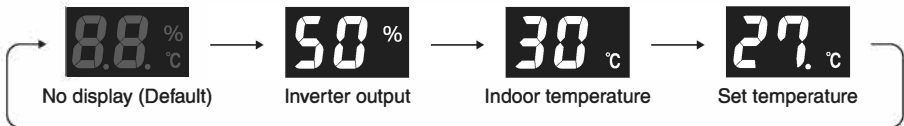

- Inverter output service as an estimate of power consumption.(where rated power consumption is 100%)
- There is a “.”(dot) after the set temperature figure.
- Inverter output does not display when the unit is in FAN operation.
- Set temperature does not display when the unit is in DRY operation or FAN operation.
- Inverter output and set temperature may not display depending on the operation mode that is active.
- The display turns off when the unit is turned off.

■ Checking current indoor temperature when the air conditioner is off

1. Press when the air conditioner is OFF and remote is ON.

- The current indoor temperature displays.
- Press the button again to turn off the display.

NOTE

■ Note on the inverter output and temperature display

- “F.L.” displays as inverter output when the rated power consumption is exceeded.
- “ - - ” may display for a short while after the air conditioner is turned on or at other times.
- Inverter output may be low at times for the purposes of protecting the product.
- When the unit is operated using another device, such as a wired remote controller or smartphone, the set temperature displayed may not match the set temperature on the remote controller.
- An error code will display if the air conditioner fails to operate when turned on. Consult your service centre. Refer to the error code table in “**Troubleshooting**”.



LED / 7 SEGMENT BRIGHTNESS Control Operation

The brightness of the indicator lamp / 7 Segment can be adjusted H(high), L(low), or OFF.

To set the brightness setting mode.

- Press  for more than 5 second's.

● **Ld** is displayed on the LCD.

- Press  will show the last memory setting of brightness intensity of indicator lamp/ 7 Segment.

- Again Press  to adjust the brightness to the indicator lamp / 7 Segment.

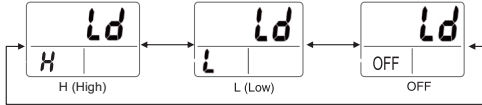

- Press  for about or more than 5 second's again to exit from the brightness setting mode or when the remote controller is left untouched for 60 second's, it returns to the normal mode automatically.

DEW CLEAN Operation

This Function helps to clean accumulation of Dust & Stain on indoor Heat Exchanger.

- To use **DEW CLEAN** operation, Remote Controller and Machine should be in **ON** operation and follow the below steps.



- Press **DEW CLEAN** for more than 2 second's and release the button then "C" blinks on the remote LCD 4 times and then it disappears.

- The **LED** indicator lamp (green and orange) on the Indoor Unit will blink together during the operation.



- The operation stops automatically as per below defined process and unit will switched OFF after completion.

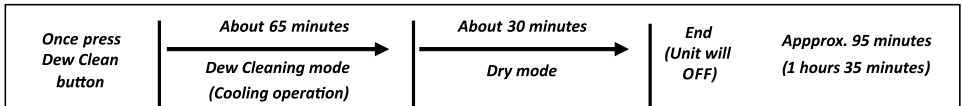

To cancel **DEW CLEAN** operation

-Turn OFF the machine from Remote Controller / Wi-Fi Control

NOTE

- Note on LED / 7 Segment Brightness Control :
 - "Ld" indicates for the brightness (Light) feature which is appeared on set temperature area.
 - Remote will be in High Brightness Intensity by default whenever batteries inserted.
 - Keep this in mind that If user sets LED lights to be in "OFF" state (using Brightness control feature) and if Power failure occurs then when power will resume LED will remain in OFF state (needs to reset LED Brightness Control again)
- Note on **DEW CLEAN** operation :
 - During **DEW CLEAN** operation, except Streamer other functions of Remote will not work.
 - Automatically controls temperature and airflow rate, so manual adjustment of these function is unavailable.
 - If Mains Power Reset or Power failure occur, Dew Clean Operation will stop.
 - User is recommended to avoid staying inside the room during Dew Clean operation as Indoor temperature will be lower.
 - If room temperature is lower than minimum remote temperature setting then this function will not work.
 - Recommended temperature range to operate this function is more than 24° C.
 - Recommended to use this function once in a month to get better cooling effect.
 - Do not keep LED lights in "OFF" state (using Brightness control feature) before starting Dew Clean Operation, otherwise light will not blink during the operation making it difficult to identify the Dew Clean mode.
 - This function is available in both **COOL** and **DRY** Mode of operation.

⚠ CAUTION

- Before cleaning, be sure to stop the operation and turn off the circuit breaker.

Units

■ Indoor unit and remote controller

1. Wipe them with a dry soft cloth.

■ Front panel

1. Open the front panel.

- Hold the front panel by the indentations in the unit and open the front panel.



2. Remove the front panel.

- Slide the front panel to either the left or right and pull it toward you to disengage one of the front panel shafts.
- Disengage the front panel shaft on the other side in the same manner.
- After disengaging both front panel shafts, pull the front panel toward yourself and remove it.

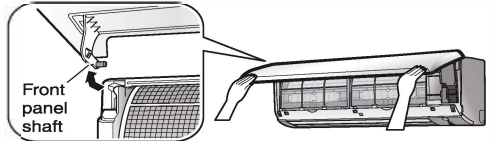

3. Clean the front panel.

- Wipe it with a soft damp cloth.
- Only neutral detergent may be used.
- In case of washing the panel with water, wipe it with a dry soft cloth, and let it dry in the shade after washing.

4. Attach the front panel.

- Align the front panel shaft on the left and right of the front panel with the grooves, then push them all the way in.
- Close the front panel slowly.
- Press the front panel at both sides and the centre.
- After cleaning, make sure that the front panel is securely fixed.



⚠ CAUTION

- Do not touch the aluminium fins of the indoor unit. If you touch those parts, this may cause an injury.
- When removing or attaching the front panel, use a robust and stable stool and watch your steps carefully.
- When removing or attaching the front panel, support the panel securely with hand to prevent it from falling.
- For cleaning, do not use hot water above 40°C, benzene, gasoline, thinner, nor other volatile oils, polishing compound, scrubbing brushes, nor other hard stuff.
- After cleaning, make sure that the front panel is securely fixed.

Air Filter

1. Pull out the air filters.

- Open the front panel.
- Push the filter tab at the centre of each air filter a little upwards, then pull it down.

2. Wash the air filters with water or clean them with a vacuum cleaner.

- If the dust does not come off easily, wash them with neutral detergent thinned with lukewarm water, then let them dry in the shade.
- Be sure to remove the accessory filter (optional part)
- It is recommended to clean the air filters every 2 weeks.

3. Reattach the filters and close the front panel.

Insert the filters into slots of the front grille. Close the front panel slowly and push the panel at the 3

- points.
- Press the front at both sides and the centre.

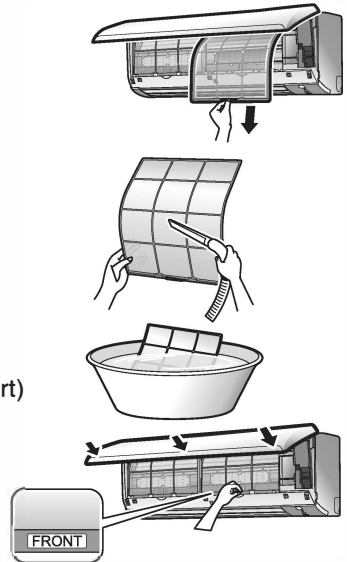

Accessory Filter

Filter type: Ag-ion filter / Micro-filter (PM2.5 & PM1.0)

[Maintenance]

The accessory filters can be renewed by cleaning them with a vacuum cleaner once every 6 months. We recommend replacing them once every 6.5 years.

1. Take off the accessory filters.

- 1) Open the front panel and pull out the air filters.
- 2) Take off the accessory filters.
 - Remove the accessory filters from the tabs.

2. Vacuum dust.

- Do not wash the accessory filters as this will reduce their efficiency.

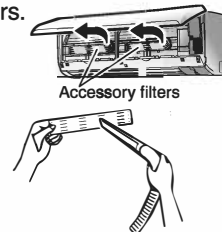

Care and Cleaning

[Replacement]

1. Replace the old accessory filters with new accessory filters.

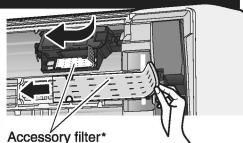

Accessory Filter

Filter type: Titanium apatite deodorizing air purifying filter/ Anti microbial filter

[Maintenance]

The accessory filters can be renewed by washing them with water once every 6 months. We recommend replacing them once every 3 years.

1. Take off the accessory filters.

- For removal procedures, refer to “Accessory filter” on the previous page.

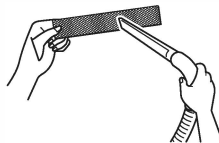

2. Vacuum dust and soak in lukewarm water for about 10 to 15 minutes if very dirty.

3. After washing, shake off remaining water and dry in the shade.

- Do not wring out the accessory filters to remove water from them.



[Replacement]

1. Replace the old accessory filters with new accessory filters.

NOTE

- When applying for the filter for the first time, specify “with frame”.
- To order an optional filter, contact the service shop where you bought the air conditioner.
- Dispose of the old filter as non-flammable waste.
- Dispose of the old filter frame in accordance with your local waste sorting procedures.

Item	Part No.
Titanium apatite deodorizing air-purifying filter (1 set)	KAF970A45
Ag-ion filter (1 set)	KAF057A41
Anti Microbial filter (1 set)	KAF500A504
Micro-filter - PM2.5 (1 set)	KAF250A502
Micro-filter - PM2.5 for streamer unit (1 set)	KAF250A505
Micro-filter - PM 1.0 for streamer unit (1 set)	KAF100A507

- Operation with dirty filters: (1) cannot deodorise the air. (2) cannot clean the air. (3) results in poor cooling. (4) may cause odour.

■ Prior to a long period of non-use

1. Operate the FAN mode for several hours on a fine day to dry out the inside.

- 1) Press **MODE** and select FAN operation.
- 2) Press **ON/OFF** and start the operation.

2. After operation stops, turn off the circuit breaker for the room air conditioner.

3. Clean the air filters and set them again.

4. To prevent battery leakage, take out the batteries from the remote controller.

We recommend periodical maintenance.

In certain operating conditions, the inside of the air conditioner may get foul after several seasons of use, resulting in poor performance. It is recommended to have periodical maintenance by a specialist in addition to regular cleaning by the user. For specialist maintenance, please contact your service centre. The maintenance cost must be borne by the user.

Troubleshooting

These cases are not problems

The following cases are not air conditioner troubles but have some reasons. You may just continue using it.

Case	Explanation
<p>Operation does not start soon.</p> <ul style="list-style-type: none"> • When “ON/OFF” button was pressed soon after operation was stopped. • When the mode was reselected. 	<ul style="list-style-type: none"> • This is to protect the air conditioner. You should wait for about 3 minutes.
<p>Air does not come out.</p>	<ul style="list-style-type: none"> • If the operation is started when the airflow setting is “Auto”, the SMELL PROOF operation starts running to prevent unpleasant odour inside the indoor unit. Wait for about 1 minute. (Except when POWER CHILL operation is set) Refer to “Adjusting the Airflow Rate / SMELL PROOF Operation”.
<p>The flaps do not start swinging immediately.</p>	<ul style="list-style-type: none"> • The air conditioner is adjusting the position of the flaps. The flaps will start moving soon.
<p>Operation stopped suddenly. (OPERATION lamp is on)</p>	<ul style="list-style-type: none"> • To protect the system, the air conditioner may stop operating after sudden large voltage fluctuations. It automatically resumes operation in about 3 minutes. Voltage range protection: 130V~285V Voltage range protection: 130V~265V for F/GTKL71UV16T Models.
<p>A sound is heard.</p>	<ul style="list-style-type: none"> ■ A sound like flowing water <ul style="list-style-type: none"> • This sound is generated because the refrigerant in the air conditioner is flowing. • This is a pumping sound of the water in the air conditioner and can be heard when the water is pumped out from the air conditioner during COOL or DRY operation. ■ Blowing sound <ul style="list-style-type: none"> • This sound is generated when the flow of the refrigerant in the air conditioner is switched over. ■ Ticking sound <ul style="list-style-type: none"> • This sound is generated when the cabinet and frame of the air conditioner slightly expand or shrink as a result of temperature changes. ■ Clopping sound <ul style="list-style-type: none"> • This sound is heard from the inside of the air conditioner when the exhaust fan is activated while the room doors are closed. Open the window or turn off the exhaust fan.
<p>The outdoor unit emits water or steam.</p>	<ul style="list-style-type: none"> ■ In COOL or DRY operation <ul style="list-style-type: none"> • Moisture in the air condenses into water on the cool surface of the outdoor unit piping and drips.
<p>Mist comes out of the indoor unit.</p>	<ul style="list-style-type: none"> • This happens when unit cooling in high humidity or if unit exposed to excessive oil, dust due to this irregular temperature may occur.

Troubleshooting

Case	Explanation
The indoor unit gives out odour.	<ul style="list-style-type: none"> The room odour absorbed in the unit is discharged with the airflow. We recommend you to have the indoor unit cleaned. Please consult your service centre.
The outdoor fan rotates while the air conditioner is not in operation.	<ul style="list-style-type: none"> Immediately after the air conditioner is stopped: <ul style="list-style-type: none"> The outdoor unit fan continues rotating for about another 1 minute to protect the system. While the air conditioner is not in operation: <ul style="list-style-type: none"> When the outdoor temperature is high, the outdoor unit fan may start rotating to protect the system.
Remote controller does not work properly.	<ul style="list-style-type: none"> No remote controller signals are displayed. The remote controller sensitivity is low. The display is low in contrast or blacked out. The display runs out of control. <ul style="list-style-type: none"> The batteries are dying and the remote controller is malfunctioning. Replace both batteries with new, dry batteries (AAA). For details, refer to “To insert the batteries” of this manual.

Check again

Please check again before requesting repairs.

Case	Explanation
The air conditioner does not operate. (OPERATION lamp is off)	<ul style="list-style-type: none"> Has the circuit breaker been tripped or the fuse blown? Is there a power failure? Are batteries set in the remote controller? Is the timer setting correct?
The room does not cool down.	<ul style="list-style-type: none"> Is the airflow rate setting appropriate? If the airflow rate setting is too low, increase it. Is the set temperature appropriate? Is the adjustment of the airflow direction appropriate? Are the air filters dirty? Is there anything blocking the air inlet or air outlet of the indoor unit or outdoor unit? Is a window or door open? Is the air conditioner in ECONO operation or GOOD SLEEP OFF TIMER operation?
Operation stops suddenly. (OPERATION lamp is blinking)	<ul style="list-style-type: none"> Are the air filters dirty? Clean the air filters. Is there anything blocking the air inlet or air outlet of the indoor unit or outdoor unit? Stop operation and after turning off the circuit breaker, remove the obstruction. Then restart operation with the remote controller. If the OPERATION lamp is still blinking, check the error code and consult your service centre. If the lamp stop blinking after the above steps, there is no malfunction.
An abnormal functioning happens during operation.	<ul style="list-style-type: none"> The air conditioner may malfunction with lightning or radio waves. Turn off the circuit breaker, turn it on again and try operating the air conditioner with the remote controller.

Call your service centre immediately

WARNING

- When an abnormality (such as a burning smell) occurs, stop operation and turn off the circuit breaker.
Continued operation in an abnormal condition may result in problems, electric shock or fire. Consult your service centre.
- Do not attempt to repair or modify the air conditioner by yourself.
Incorrect work may result in electric shock or fire. Consult your service centre.

If one of the following symptoms takes place, call your service centre immediately.

- The power cord is abnormally hot or damaged.
- An abnormal sound is heard during operation.
- The circuit breaker, a fuse, or the earth leakage circuit breaker cuts off the operation frequently.
- A switch or a button often fails to work properly.
- There is a burning smell.
- Water leaks from the indoor unit.



Turn off the circuit breaker and call your service centre.

- After a power failure
The air conditioner automatically resumes operation in about 3 minutes. You should just wait for a while.

- Lightning
If there is a risk lightning could strike in the neighbourhood, stop operation and turn off the circuit breaker to protect the system.

Disposal requirements



Your air conditioning product is marked with this symbol. This means that electrical and electronic products shall not be mixed with unsorted household waste.

Do not try to dismantle the system yourself: the dismantling of the air conditioning system, treatment of the refrigerant, of oil and of other parts must be done by a qualified installer in accordance with relevant local and national legislation.

Air conditioners must be treated at a specialized treatment facility for re-use, recycling and recovery. By ensuring this product is disposed of correctly, you will help to prevent potential negative consequences for the environment and human health. Please contact the installer or local authority for more information.

Batteries must be removed from the remote controller and disposed of separately in accordance with relevant local and national legislation.

Fault diagnosis by remote controller

The remote controller can receive relevant error codes from the indoor unit.

1. When **CANCEL** is held down for about 5 seconds, “” blinks in the temperature display section.
2. Press **CANCEL** repeatedly until a long beep is produced.

- The code indication changes as shown below, and notifies with a long beep.

	CODE	MEANING
SYSTEM	00	NORMAL
	UA	INDOOR-OUTDOOR UNIT COMBINATION FAULT
	U0	REFRIGERANT SHORTAGE
	U2	DROP VOLTAGE OR MAIN CIRCUIT OVERVOLTAGE
	U4	FAILURE OF TRANSMISSION (BETWEEN INDOOR UNIT AND OUTDOOR UNIT)
INDOOR UNIT	A1	INDOOR PCB DEFECTIVENESS
	A5	FREEZE-UP PROTECTOR
	A6	FAN MOTOR FAULT
	C4	FAULTY HEAT EXCHANGER TEMPERATURE SENSOR
OUTDOOR UNIT	C9	FAULTY SUCTION AIR TEMPERATURE SENSOR
	E1	CIRCUIT BOARD FAULT
	E5	OL STARTED
	E6	FAULTY COMPRESSOR START UP
	E7	DC FAN MOTOR FAULT
	E8	OVERCURRENT INPUT
	F3	HIGH TEMPERATURE DISCHARGE PIPE CONTROL
	F6	HIGH PRESSURE CONTROL (IN COOLING)
	F8	OPERATION HALT DUE TO COMPRESSOR INTERNAL TEMPERATURE ABNORMALITY
	H0	SENSOR FAULT
	H6	OPERATION HALT DUE TO FAULTY POSITION DETECTION SENSOR
	H8	DC CURRENT SENSOR FAULT
	H9	FAULTY SUCTION AIR TEMPERATURE SENSOR
	J3	FAULTY DISCHARGE PIPE TEMPERATURE SENSOR
	J6	FAULTY HEAT EXCHANGER TEMPERATURE SENSOR
	L3	ELECTRICAL PARTS HEAT FAULT
	L4	HIGH TEMPERATURE AT INVERTER CIRCUIT HEATSINK
	L5	OUTPUT OVERCURRENT
	P4	FAULTY INVERTER CIRCUIT HEATSINK TEMPERATURE SENSOR

NOTE

- A short beep indicates non-corresponding codes.
- To cancel the code display, hold down **CANCEL** for about 5 seconds.
The code display also cancels itself if the button is not pressed for 1 minute.

DAIKIN INDUSTRIES, LTD.

Head office:
Osaka Umeda Twin Towers South
1-13-1, Umeda, Kita-ku, Osaka, 530-0001, Japan

Tokyo office:
Yaesu Central Tower, Tokyo Midtown Yaesu,
2-2-1, Yaesu, Chuo-ku, Tokyo, 104-0028, Japan
<http://www.daikin.com>

DAIKIN ROOM AIR CONDITIONER

INSTALLATION MANUAL

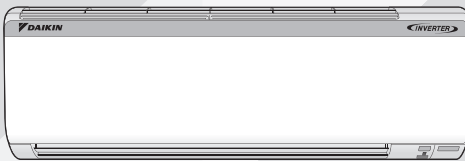

MODELS: _____

F/G/MTKM50UV16V

A/D/F/G/MTKL50UV16VA

A/D/F/G/MTKL50UV16VAF



F/GTKC50UV16V

FTKC50UV16VF



F/MTKC42UV16V

Safety Precautions

- The precautions described herein are classified as **WARNING** and **CAUTION**. They both contain important information regarding safety. Be sure to observe all precautions without fail.
- Meaning of **WARNING** and **CAUTION** notices





 WARNING	Failure to follow these instructions properly may result in personal injury or loss of life.
 CAUTION	Failure to observe these instructions properly may result in property damage or personal injury, which may be serious depending on the circumstances.

- The safety marks shown in this manual have the following meanings:

	Be sure to follow the instructions.		Be sure to establish an earth connection.		Never attempt.
---	-------------------------------------	---	---	---	----------------

- After completing installation, conduct a trial operation to check for faults and explain to the customer how to operate the air conditioner and take care of it with the aid of the operation manual.

WARNING

- Ask your dealer or qualified personnel to carry out installation work. Do not attempt to install the air conditioner yourself. Improper installation may result in water leakage, electric shocks or fire.
- Install the air conditioner in accordance with the instructions in this installation manual. Improper installation may result in water leakage, electric shocks or fire.
- Be sure to use only the specified accessories and parts for installation work. Failure to use the specified parts may result in the unit falling, water leakage, electric shocks or fire.
- Install the air conditioner on a foundation strong enough to withstand the weight of the unit. A foundation of insufficient strength may result in the equipment falling and causing injury.
- Electrical work must be performed in accordance with relevant local and national regulations and with instructions in this installation manual. Be sure to use a dedicated power supply circuit only. Insufficiency of power circuit capacity and improper workmanship may result in electric shocks or fire.
- Use a cable of suitable length. Do not use tapped wires or an extension lead, as this may cause overheating, electric shocks or fire.
- Make sure that all wiring is secured, the specified wires are used, and that there is no strain on the terminal connections or wires. Improper connections or securing of wires may result in abnormal heat build-up or fire.
- When wiring the power supply and connecting the wiring between the indoor and outdoor units, position the wires so that the control box lid can be securely fastened. Improper positioning of the control box lid may result in electric shocks, fire or over heating terminals.
- If refrigerant gas leaks during installation, ventilate the area immediately. Toxic gas may be produced if the refrigerant comes into contact with fire. 
- After completing installation, check for refrigerant gas leakage. Toxic gas may be produced if the refrigerant gas leaks into the room and comes into contact with a source of fire, such as a fan heater, stove or cooker. 
- When installing or relocating the air conditioner, be sure to bleed the refrigerant circuit to ensure it is free of air, and use only the specified refrigerant (R32). The presence of air or other foreign matter in the refrigerant circuit causes abnormal pressure rise, which may result in equipment damage and even injury.
- During installation, attach the refrigerant piping securely before running the compressor. If the refrigerant pipes are not attached and the stop valve is open when the compressor is run, air will be sucked in, causing abnormal pressure in the refrigeration cycle, which may result in equipment damage and even injury.
- During pump-down, stop the compressor before removing the refrigerant piping. If the compressor is still running and the stop valve is open during pump-down, air will be sucked in when the refrigerant piping is removed, causing abnormal pressure in the refrigeration cycle, which may result in equipment damage and even injury.
- Be sure to earth the air conditioner. Do not earth the unit to a utility pipe, lightning conductor or telephone earth lead. Imperfect earthing may result in electric shocks. 
- Be sure to install an earth leakage circuit breaker. Failure to install an earth leakage circuit breaker may result in electric shocks or fire.
- Do not pump down when the refrigerant has leaked, otherwise the compressor may be damaged. 

CAUTION

- Do not install the air conditioner at any place where there is a danger of flammable gas leakage. In the event of a gas leakage, build-up of gas near the air conditioner may cause a fire to break out. 
- While following the instructions in this installation manual, install drain piping to ensure proper drainage and insulate piping to prevent condensation. Improper drain piping may result in indoor water leakage and property damage.
- Tighten the flare nut according to the specified method such as with a torque wrench. If the flare nut is too tight, it may crack after prolonged use, causing refrigerant leakage.
- Take adequate steps to prevent the outdoor unit being used as a shelter by small animals. Small animals making contact with electrical parts can cause malfunctions, smoke or fire. Please instruct the customer to keep the area around the unit clean.
- The temperature of refrigerant circuit will be high, please keep the inter-unit wires away from copper pipes that are not thermally insulated.

Accessories (A ~ T)

ITEM	QTY.	Remarks	ITEM	QTY.	Remarks
(A) Mounting plate	1	○	(K) Remote controller holder fixing screw (M3 x 20L)	2	※
(B) Mounting plate fixing screw (M4 x 25L)	6/7*	○	(L) 4-Core wire (3.7M)	1	※
(C) Wireless Remote Controller	1	○	(M) Tie wrap	6	※
(D) Dry battery (AAA)	2	※	(N) Accessory filter	1/2*	※
(E) Indoor Unit Fixing Screw (M4 x 12L)	2	○	(P) Gas pipe (3.0M)	1	※
(F) Operation Manual + Installation Manual	1+1	○	(Q) Liquid pipe (3.0M)	1	※
(G) E-Waste (Guideline)	1	○	(R) Drain socket	1	※
(H) Product warranty	1	○	(S) Heat insulation tape	1	※
(I) Remote controller holder	1	※	(T) Wi-Fi manual	1	※

*'O' Applicable for all models '※' Applicable only for selected models '**' Quantity may vary model to model.

Note: The accessories parts included with the unit displayed on the packing case name plate / Label of indoor and outdoor packing case

Table No. 1

Precautions for Selecting a Location

• Before choosing the installation site, obtain user approval.

Indoor unit

The indoor unit should be positioned in a place where:

- 1) the restrictions on the installation requirements specified in "Indoor/Outdoor Installation Diagram" are met,
- 2) both the air inlet and air outlet are unobstructed,
- 3) the unit is not exposed to direct sunlight,
- 4) the unit is away from sources of heat or steam,
- 5) there is no source of machine oil vapour (this may shorten the indoor unit service life),
- 6) cool air is circulated throughout the room,
- 7) the unit is away from electronic ignition type fluorescent lamps (inverter or rapid start type) as they may affect the remote controller range,
- 8) the unit is at least 1m away from any television or radio set (the unit may cause interference with the picture or sound),
- 9) the unit can be installed at the recommended height (1.8m),
- 10) no laundry equipment is nearby.

Outdoor unit

The outdoor unit should be positioned in a place where:

- 1) the restrictions on the installation requirements specified in "Indoor/Outdoor Installation Diagram" are met,
- 2) drain water causes no trouble or problem in particular,
- 3) both air inlet and outlet have clear paths of air (they should be free of snow in snowy districts),
- 4) the unit is in a clear path of air but not directly exposed to rain, strong winds, or direct sunlight,
- 5) there is no fear of inflammable gas leakage,
- 6) the unit is not directly exposed to salt, sulfidized gases, or machine oil vapour (these may shorten the service life of the outdoor unit),
- 7) operating sound or hot airflow does not cause trouble to neighbours,
- 8) the unit is at least 3m away from any television or radio antenna.

Outdoor Unit Installation Space Requirements

⚠ CAUTION

When carrying the outdoor unit during installation, wear gloves to avoid injury.

- Position the unit on a horizontal surface.
- Any tilt in the unit (front to back, right to left) should be 3° or less to the horizontal.
- Where a wall or other obstacle is in the path of the outdoor unit's intake or exhaust airflow, follow the installation space requirements below.
- For any of the below installation patterns, the wall height on the outlet side should be 1200mm or less.

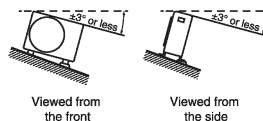

Viewed from the front

Viewed from the side

Wall facing one side

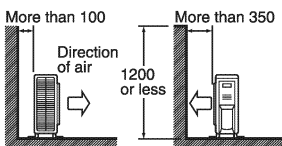

Side view

Walls facing two sides

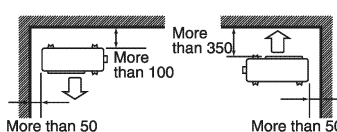

Top view

Walls facing three sides

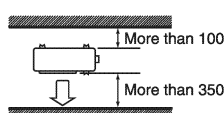

Top view

unit: mm

Indoor/outdoor Unit Installation Diagram

• The mounting plate should be installed on a wall which can support the weight of the indoor unit.

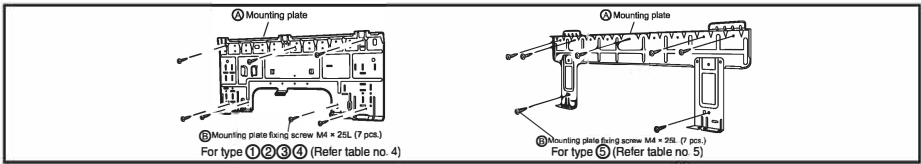

Note: Before installation, mounting plate size & shape must be matched with mounting plate available in the unit, then accordingly follow the installation instruction.

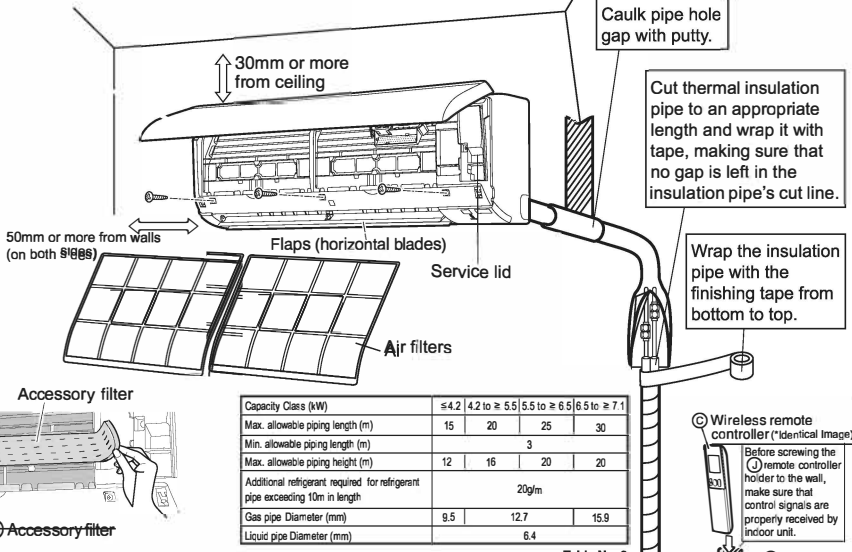

Capacity Class (kW)	≤4.2	4.2 to ≤5.5	5.5 to ≤6.5	6.5 to ≤7.1
Max. allowable piping length (m)	15	20	25	30
Min. allowable piping length (m)	3			
Max. allowable piping height (m)	12	16	20	20
Additional refrigerant required for refrigerant pipe exceeding 10m in length	20g/m			
Gas pipe Diameter (mm)	9.5	12.7	15.9	
Liquid pipe Diameter (mm)	6.4			

Table No. 2

* Be sure to add the proper amount of additional refrigerant. Failure to do so may result in reduced performance.

** The suggested shortest pipe length is 3m, in order to avoid noise from the outdoor unit and vibration.
(Mechanical noise and vibration may occur depending on how the unit is installed and the environment in which it is used.)

Dimensions of ODU installation leg*				
Type	Applicable unit size* [H] X [W] X [D]	A	B	C
①	418 x 695 x 244	467	119.5	287
②	550 x 675 x 284	470	97	308
③	550 x 765 x 285	573.5	131	326
④	595 x 845 x 300	574	105.5	311
⑤	695 x 930 x 350	610	175	367

* Unit size available on name plate.

Table No. 3

In sites with poor drainage, use block bases for outdoor unit. Adjust foot height until the unit is leveled. Otherwise, water leakage or pooling of water may occur.

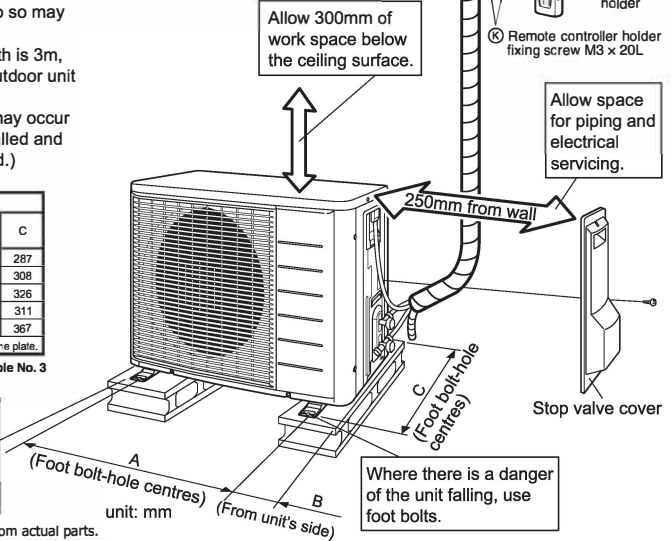

Note: All shapes or appearance may vary from actual parts.

Installation Tips

■ Installing and Removing the indoor unit.

• Installation method

Hook the claws of the bottom frame to the mounting plate. If the claws are difficult to hook, remove the front grille.

• Removal method

Push up the marked area (at the lower part of the front grille) to release the claws. If it is difficult to release, remove the front grille.

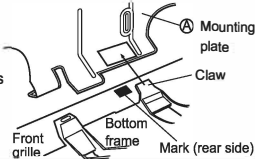

⚠ CAUTION

Do not hold the midsection of the bottom of the front grille when carrying the indoor unit.

■ Removing and installing the front panel.

• Removal method

Hold the front panel by the indentations in the main unit and open the panel. Slide the front panel sideways to disengage the front panel shaft.

Then pull the front panel toward you to remove it.

You can also remove the front panel by pushing it open until the front panel shaft is disconnected.

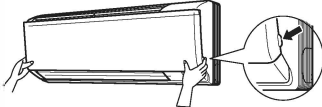

• Installation method

Align the front panel shaft of the front panel with the grooves, and push all the way in. Then close slowly. Push the centre of the lower surface of the panel firmly.

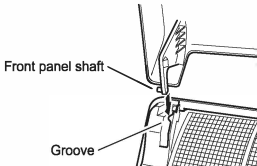

■ Removing and installing the front grille.

• Removal method

- 1) Remove the front panel to remove the air filter.
- 2) Remove the flap (horizontal blade).
- 3) Remove the front grille. (3 screws)
- 4) In front of the ○○○ mark of the front grille, there are 3 upper hooks. Lightly pull the front grille toward you with one hand, and push down on the hooks with the fingers of your other hand.

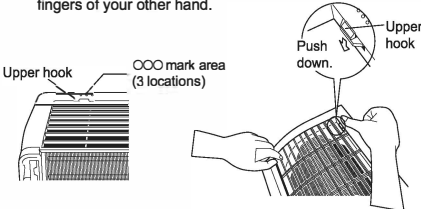

<When there is no work space because the unit is close to ceiling>

⚠ CAUTION

Be sure to wear protection gloves.

1) Push up.



Place both hands under the centre of the front grille, and while pushing up, pull it toward you. 2) Pull toward you.

• Installation method

- 1) Install the front grille and firmly engage the upper hooks (3 locations).
- 2) Install 3 screws of the front grille.
- 3) Install the air filter and then mount the front panel.

■ Opening the service lid.

The service lid is opening/closing type.

• Opening method

- 1) Remove the service lid screws.
- 2) Pull out the service lid diagonally down in the direction of the arrow.
- 3) Pull down.

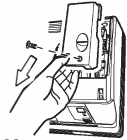

■ How to set the different addresses.

For type ① ② ③ ④ (Refer table no.4)

When 2 indoor units are installed in one room, the 2 wireless remote controllers can be set for different addresses. Change the address setting of one of the two units.

When cutting the jumper (J4) be careful not to damage any of the surrounding parts.

- 1) Remove the battery cover on the remote controller and cut the address jumper (J4).

- 2) Press , and **(MODE)** at the same time.

- 3) Press , select , press **(MODE)**.

(The indoor unit OPERATION lamp will blink for about 1 minute.)

- 4) Press the indoor unit ON/OFF switch while the OPERATION lamp is blinking.

■ How to set the different addresses.

For type ⑤ (Refer table no.5)

When two indoor units are installed in one room, the two wireless remote controllers can be set for different addresses.

- 1) Remove the front grille. (5 screws)
- 2) Remove the service lid. (1 screw)
- 3) Remove the electrical wiring cover. (3 tabs)
- 4) Pull out the PCB.
- 5) Cut the address jumper (JA) on the printed circuit board.
- 6) Cut the address jumper (J4) in the remote controller.

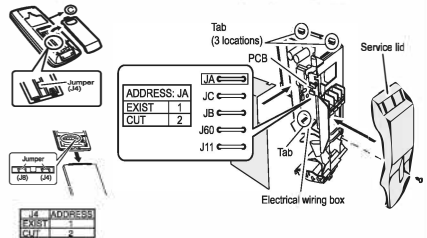

- If setting could not be carried out completely while the OPERATION lamp was blinking, carry out the setting process once again from the beginning.

- After setting is complete, pressing **(MODE)** for about 5 seconds will cause the remote controller to return to the previous display.

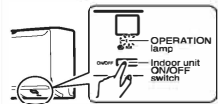

Note:

Remove polythene film from front panel wherever applied.

Indoor Unit

1 Installing The Mounting Plate

- The mounting plate should be installed on a wall which can support the weight of the indoor unit.
- 1) Temporarily secure the mounting plate to the wall, make sure that the panel is completely level, and mark the boring points on the wall.
- 2) Secure the mounting plate to the wall with screws.

Recommended mounting-plate retention spots and Dimensions

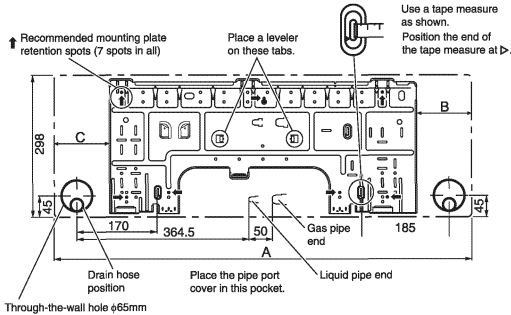

Applicable Unit Size*				
Type	[H] X [W] X [D]	A	B	C
①	298 x 800 x 229	800	116.5	116.5
②	298 x 821 x 235	821	128	126.5
③	298 x 885 x 229	885	116.5	116.5
④	298 x 906 x 235	906	127	127.5

* Unit size available on name plate.

Table No. 4

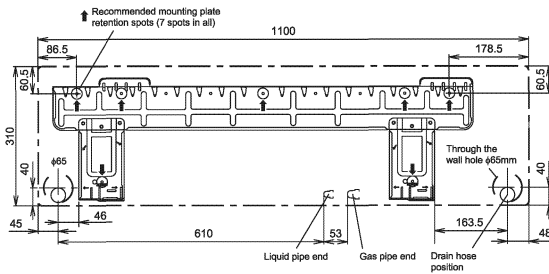

Applicable Unit Size*	
Type	[H] X [W] X [D]
⑤	310 x 1100 x 239

* Unit size available on name plate.

Table No. 5

All dimensions are in mm.

2 Drilling A Wall Hole And Installing Wall Embedded Pipe

⚠ WARNING

For metal frame or metal board walls, be sure to use a wall embedded pipe and wall hole cover in the feed-through hole to prevent possible heat, electrical shock, or fire.

- Drill a feed-through hole with a 65mm diameter through the wall at a downward angle toward the outside.
- Insert a wall embedded pipe into the hole.
- Insert a wall hole cover into wall pipe.

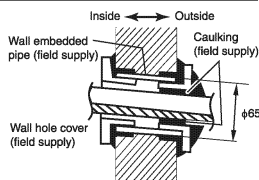

Indoor Unit

3 Installing The Indoor Unit

Right-Side, Right-Back or Right-Bottom Piping

- 1) Open the front panel, open the Front grille (If Required), then open the service lid. (Refer to Installation Tips.)
- 2) Shape the refrigerant pipes.
- 3) Pass the drain hose and refrigerant pipes through the wall hole.
- 4) Hang the indoor unit on (A) mounting Plate
- 5) Pass the inter-unit wires from the outdoor unit through the feed-through wall hole and then through the back of the indoor unit. Pull them through the front side. Bend the ends of tie wires upward in advance for easier work. (If the inter unit wires ends are to be stripped first, bundle wire ends with adhesive tape.)
- 6) Connect the refrigerant pipes.
- 7) Bind refrigerant pipe and drain hose with vinyl tape then wrap the refrigerant pipes and drain hose together with insulation tape (field supply) as shown in the figure.
- 8) Hook the claws of the bottom frame to the mounting plate, press the bottom frame of the indoor unit with both hands to set it on the (A) mounting plate hooks. Make sure the wire lead do not catch on the edge of the indoor unit.
- 9) Secure the indoor unit to the (A) mounting plate with the (E) indoor unit fixing screws (M4 x 12L).
- 10) Caulk the gap between the pipe and the front grille with putty.
- 11) After completing refrigerant piping, wiring and drain piping, caulk pipe hole gap with putty.

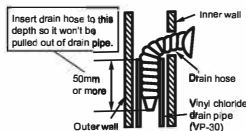
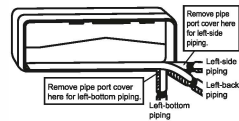
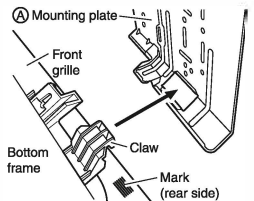
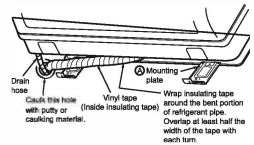
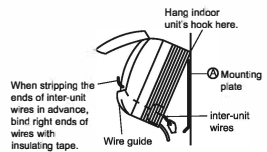
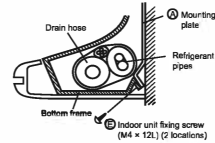
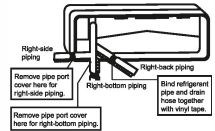

Left-Side, Left-Back, or Left-Bottom Piping

For left piping addition things need to be taken care.

- 1) Be sure to connect the drain hose to the drain port in place of a drain plug.
- 2) Install the unit as per mentioned above RHS side.

Well Embedded Piping

- 1) Insert the drain hose to this depth so it won't be pulled out of the drain pipe

Indoor Unit

4 Wiring

- Strip wire ends (15mm).
- Match wire colours with terminal numbers on indoor and outdoor unit's terminal blocks and firmly screw wires to the corresponding terminals with the screw.
- Connect the earth wires to the corresponding terminals. Attach the earth wire so that it is not connected to the fan motor connector.
- Pull wires to make sure that they are securely latched up, then retain wires with wire retainer.
- Shape the wires so that the service lid fits securely, then close service lid.

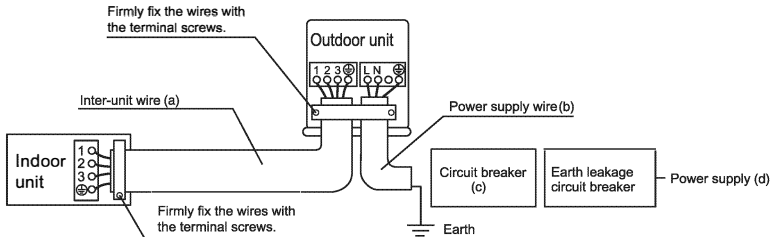
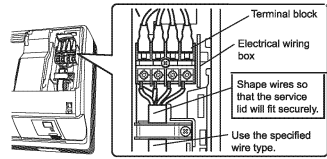

Capacity Class (kW)	2.5~3.7	above 3.7 and upto 7.1
Inter Unit wire (a)	4-core, 1.0 mm ² or more	4-core, 1.5 mm ² or more
Power supply wire (b)	3-core, 1.5 mm ² or more	
Wire Standard	IS:694 or country specific standard.	
Circuit breaker size (c)	15A or more	20A or more
Power supply (d)	50Hz 230V~ or Country specific	

Note: Use 4-core 1.5 mm² wire if wire is not included with the unit.

Table No. 6

⚠ WARNING

- Use a stabiliser if required by the voltage supply condition.
- Do not use tapped wires, extension cords, or starburst connections, as they may cause overheating, electrical shock, or fire.
- Do not use locally purchased electrical parts inside the product. (Do not branch the power for the drain pump, etc., from the terminal block.) Doing so may cause electric shock or fire.

5 Drain Piping

- Connect the drain hose, as described right.
- Remove the air filters and pour some water into the drain pan to check the water flows smoothly.
- When drain hose requires extension, obtain an extension hose commercially available. Be sure to thermally insulate the indoor section of the extension hose.
- When connecting a rigid polyvinyl chloride pipe (nominal diameter 13mm) directly to the drain hose attached to the indoor unit as with embedded piping work, use any commercially available drain socket (nominal diameter 13mm) as a joint.

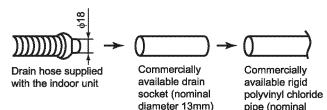
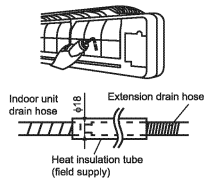
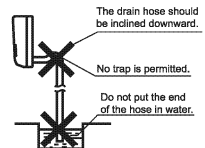

Binding Of Insulation Pipe

1. The slit direction should be upward.
2. It should be sealed with vinyl tape without any gap.
3. Do not over tighten with vinyl tape.

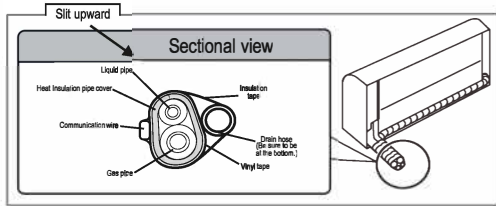

Wrap vinyl tape with the slit of the heat insulation pipe cover facing up so that there are no gap . If there is a gap or if it is tightened too much, it may cause condensation or water dripping.



This illustration shows the case of the left rear piping.

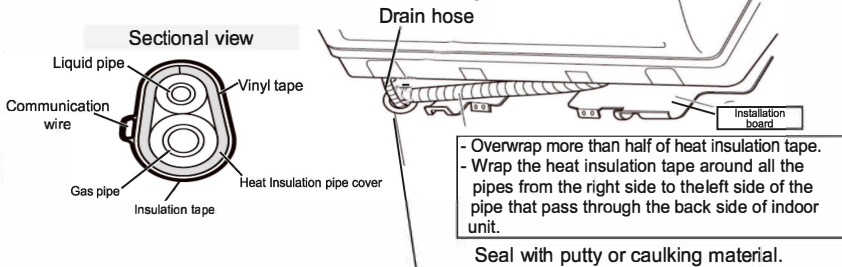

⚠ WARNING

Fill the gap from both the indoor side and the outdoor side to prevent dew condensation, misdetection of indoor temperature, and invasion of small animals.

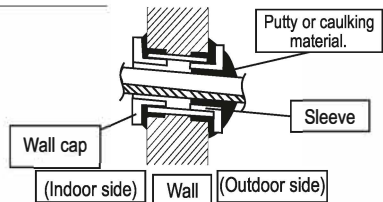

Outdoor Unit

1 Installing The Outdoor Unit

- When installing the outdoor unit, refer to "Precautions for Selecting a Location" and the "Outdoor Unit Installation Diagram".

2 Flaring The Pipe End

⚠ WARNING

Incomplete flaring may result refrigerant gas leakage.

- Cut the pipe end with a pipe cutter.
- Remove burrs with the cut surface facing downward, so that the fillings do not enter the pipe.
- Put the flare nut on the pipe.
- Flare the pipe.
- Check that the flaring has been done correctly.

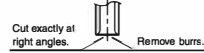

Flaring

Set exactly at the position shown below

Flare tool for R410A/R32	Conventional flare tool	
	Clutch-type	Wing-nut type (Imperial-type)
Die	Clutch-type (Rigid-type)	1.0-1.5mm
A	0-0.5mm	1.5-2.0mm

Check

The flare's inner surface must be **flaw-free**.

The pipe end must be evenly flared in a perfect circle.

Make sure that the flare nut is fitted.

3 Refrigerant Piping

- To prevent gas leakage, apply refrigeration oil to the inner surface of the flare.
- Align the centres of both flares and tighten the flare nuts 3 or 4 turns by hand. Then tighten them fully with the torque wrenches.
 - Use torque wrenches when tightening the flare nuts to prevent damage to the flare nuts and escaping gas.

	Piping size	Flare nut tightening torque	Valve cap tightening torque	Service port cap tightening torque
Gas side	O. D. 9.5mm	32.7-39.9N • m (333-407 kgf • cm)	21.6-27.4N • m (220-280 kgf • cm)	10.8-14.7N • m (110-150 kgf • cm)
	O. D. 12.7mm	49.5-60.3N • m (505-615 kgf • cm)	48.1-59.7N • m (490-610 kgf • cm)	
	O. D. 15.9mm	61.8-75.4N • m (630-770 kgf • cm)		
Liquid side	O. D. 6.4mm	14.2-17.2N • m (144-175 kgf • cm)	21.6-27.4N • m (220-280 kgf • cm)	

Table No. 7

Cautions on Pipe Handling

- Protect the open end of the pipe against dust and moisture.
- All pipe bends should be as gentle as possible. Use a pipe bender for bending.

Selection of Copper and Heat Insulation materials

When using commercial copper pipes and fittings, observe the following:

- Insulation material : Polyethylene foam or equivalent.
Heat transfer rate - Co-efficient : 0.041 to 0.052W/m²K
(0.035 to 0.045kcal/m²h°C)

- Be sure to insulate both the gas and liquid piping and to provide insulation dimensions as below.

	Piping size	Minimum bend radius	Piping thickness	Thermal insulation size	Thermal insulation thickness
Gas side	O. D. 9.5mm	30 mm or more	Thickness 0.6mm (C1220T-O)	I.D 12-15mm	Thickness min.6.5mm
	O.D. 12.7mm	40 mm or more	Thickness, 0.6mm (C1220T-O)	I.D 14-16mm	
	O. D. 15.9mm	50 mm or more	Thickness 0.8mm (C1220T-O)	I.D 16-20mm	
Liquid side	O. D. 6.4mm	30 mm or more	Thickness 0.6mm (C1220T-O)	I.D 8-10mm	

Table No. 8

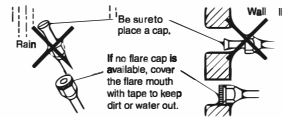

- Use separate thermal insulation pipes for gas and liquid refrigerant pipes.

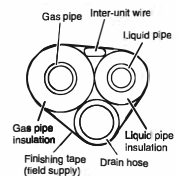

Outdoor Unit

4 Purging Air And Checking Gas Leakage

⚠ WARNING

- Do not mix any substance other than the specified refrigerant (R32) into the refrigeration cycle.
- When refrigerant gas leaks occur, ventilate the room as soon and as much as possible.
- To prevent air pollution, a vacuum pump should be used for air purging wherever possible.

- If using additional refrigerant, perform air purging from the refrigerant pipes and indoor unit using a vacuum pump, then charge additional refrigerant.
- Use a hexagonal wrench to operate the stop valve rod.
- All refrigerant pipe joints should be tightened with a torque wrench at the specified tightening torque.

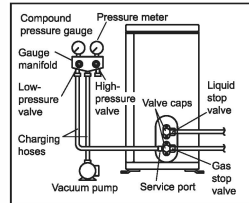

- 1) Connect projection side (on which pin is pressed) of charging hose (which comes from gauge manifold) to gas stop valve's service port.
- 2) Fully open gauge manifold's low-pressure valve (Lo) and completely close its high-pressure valve (Hi). (High-pressure valve subsequently requires no operation.)
- 3) Do vacuum pumping and make sure that the compound pressure gauge reads -0.1MPa (-76cmHg) *1.
- 4) Close gauge manifold's low-pressure valve (Lo) and stop vacuum pump. (Keep this state for a few minutes to make sure that the compound pressure gauge pointer does not swing back.) *2.
- 5) Remove valve cap from liquid stop valve and gas stop valve.
- 6) Turn the liquid stop valve's rod 90 degrees counterclockwise with a hexagonal wrench to open valve. Close it after 5 seconds, and check for gas leakage. Using soapy water, check for gas leakage from indoor unit's flare and outdoor unit's flare and valve rods. After the check is complete, wipe all soapy water off.
- 7) Disconnect charging hose from gas stop valve's service port, then fully open liquid and gas stop valves. (Do not attempt to turn valve rod beyond its stop.)
- 8) Tighten valve caps and service port caps for the liquid and gas stop valves with a torque wrench at the specified torques.

*1. Pipe length vs. vacuum pump run time

Pipe length	Up to 15m	More than 15m
Run time	Not less than 10 min.	Not less than 15 min.

*2. If the compound pressure gauge pointer swings back, refrigerant may have water content or a loose pipe joint may exist. Check all pipe joints and retighten nuts as needed, then repeat steps 2) through 4).

5 Wiring

- For inter-unit wires connections, see **INDOOR UNIT**, **4 WIRING**.

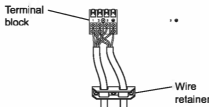

- Regarding the interconnecting and power cables.

⚠ WARNING

Never use short cables for connecting end of conductor to each other.

- When connecting the connection wires to the terminal block using a single core wire, be sure to perform curling. Problems with the work may cause heat and fires.

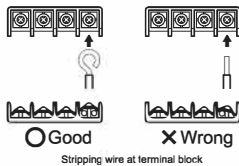

- Precaution to be taken for power supply wiring.
- When using stranded wires, make sure to use a round crimp-style terminal for connection to the power supply terminal block. Place the round crimp-style terminals on the wires up to the covered part and secure in place.

Strip wire end to this point.



Excessive strip length may cause electrical shock or leakage.



Stranded wire

6 Drain Work

- 1) Use the drain socket for drainage.
- 2) When attaching the drain socket to the bottom frame, make sure the connect the drain hose to the drain socket first.
- 3) If the drain port is covered by a mounting base or floor surface, place additional foot bases of at least 30mm in height under the outdoor unit's feet.
- 4) In cold areas, do not use a drain hose with outdoor unit. (Drain water may freeze, impairing heating performance.)

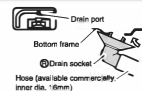

Trial Operation And Testing

1. Trial operation and testing

- Check that the inter-unit wire is correctly connected.
- Trial operation should be carried out in COOL operation.
- 1-1 Measure the supply voltage and make sure that it is within the specified range.**
- 1-2 Select the lowest programmable temperature.**
- 1-3 Carry out the trial operation following the instructions in the operation manual to ensure that all functions and parts, such as the movement of the flaps, are working properly.**
- To protect the air conditioner, restart operation is disabled for 3 minutes after the system has been turned off.
- 1-4 After trial operation is complete, set the temperature to a normal level (26°C to 28°C in COOL operation, 20°C to 24°C in HEAT operation).**
- When operating the air conditioner in COOL operation in winter, or HEAT operation in summer, set it to the trial operation mode using the following method.
 - 1) Press "MODE" button and select the cooling or heating mode.
 - 2) Press "ON/OFF" button to turn on the system.
 - 3) Press both of "TEMP" button and "MODE" button at the same time.
 - 4) Press "TEMP" button, select "7", and press "MODE" button for confirmation.
- Trial operation will stop automatically after about 30 minutes. To stop the operation press "ON/OFF" button.
- The air conditioner draws a small amount of power in its standby mode. If the system is not to be used for some time after installation, shut off the circuit breaker to eliminate unnecessary power consumption.
- If the circuit breaker trips to shut off the power to the air conditioner, the system will restore the original operation mode when the circuit breaker is turned on again.

2. Items to Check

Test Items	Symptom	Check
Indoor and outdoor units are installed securely.	Fall, vibration, noise	
No refrigerant gas leaks.	Incomplete cooling function	
Refrigerant gas and liquid pipes and indoor drain hose extension are thermally insulated.	Water leakage	
Draining line is properly installed.	Water leakage	
System is properly earthed.	Electrical leakage	
Only specified wires are used for all wiring, and all wires are connected correctly.	No operation or burn damage	
Indoor or outdoor unit's air intake or exhaust has clear path of air.	Incomplete cooling function	
Stop valves are opened.	Incomplete cooling function	
Indoor unit properly receives remote controller commands.	No operation	

Pump Down Operation

WARNING

- Make sure that air or any matter other than refrigerant (R32) does not get into the refrigeration cycle.
- When performing a pump down, turn off the compressor before detaching the refrigerant pipes. (If the refrigerant pipes are detached when the compressor is operating and the stop valves are open, air will be drawn in leading to abnormally high pressure in the refrigeration cycle. This may result in rupturing and bodily injury.)

In order to protect the environment, be sure to pump down when relocating or disposing of the unit.

- 1) Remove the valve cap from the liquid stop valve and gas stop valve.
- 2) Begin forced cooling operation.
- 3) After 5 to 10 minutes, close the liquid stop valve with a hexagonal wrench.
- 4) After 2 to 3 minutes, close the gas stop valve and stop forced cooling operation.
- 5) Attach the valve cap once procedures are complete.

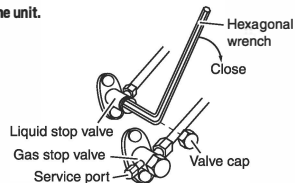

Forced cooling operation

■ Using the indoor unit ON/OFF switch

- Press and hold the indoor unit ON/OFF switch for at least 5 seconds. (The operation will start.)
- Forced cooling operation will stop automatically after about 15 minutes.
 - To stop the operation, press the indoor unit ON/OFF switch.

Disclaimer: Appearance of indoor & outdoor unit may differ between different models.

PROTECT THE ENVIRONMENT FROM E-WASTE (GUIDELINES)

Meaning of E-waste under E-Waste (Management) Rules,2022 (E-waste Rules)
-Waste electrical and electronic equipment, whole or in part of reject from their manufacturing and repair process, which are intended to be discarded.

Our product is RoHS compliant.

**Don't dump Electrical and Electronic Products in Garbage Bins****DO'S & DONT'S**

DO'S	
Run and maintain the air conditioner as per the instructions given in the operation / instruction manual	✓
Ensure that an authorised person repairs your air conditioner	✓
Call our local authorised dealer or our toll free number to dispose your air conditioner	✓
Contact an authorised dealer in case of installation or de-installation	✓
Consult our local authorised dealer or our toll free number on the life span of the air conditioner	✓

DONT'S	
Do not try to repair your air conditioner on your own	✗
Do not sell or dispose your air conditioner or parts to an unauthorised Kabbadi wala / Scrap Dealer / Ragpickers	✗
Do not dismantle your air conditioner on your own	✗
Do not get your air conditioner or any parts repaired by an unauthorised person	✗
Do not dispose off the E-waste in landfills	✗
Do not use the air conditioner as furniture after its use	✗

Customer Contact Center : 011-4031 9300/1860-180-3900

For further information visit us at www.daikinindia.com

Indoor Unit -Wiring Diagram

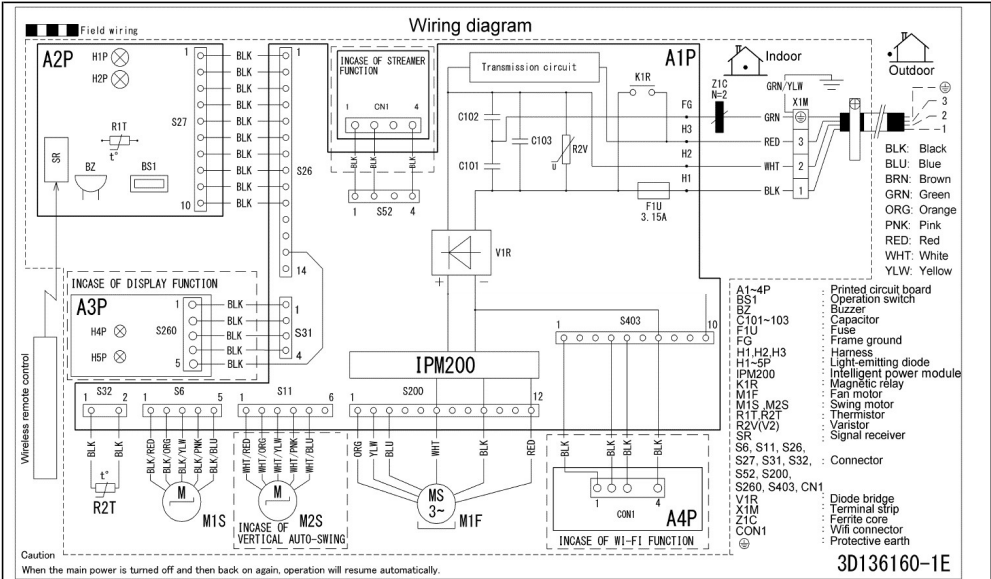

Applicable Model :- MTKL50UV16VAF, MTKL50UV16VA, DTKL50UV16VA, DTKL50UV16VA, DTKL50UV16VAF, FTKL50UV16VA, FTKC50UV16VF, FTKL50UV16VAF, FTKM50UV16V, GTKC50UV16V MTKL50UV16VA, MTKL50UV16VAF, ATKL50UV16VA, ATKL50UV16VAF, FTKL50UV16VAF, FTKC50UV16V, FTKL50UV16VA, ATKL50UV16VA, ATKL50UV16VAF, GTKL50UV16VA, GTKC50UV16VF & GTKL50UV16VAF, FTKC42UV16V, MTKC42UV16V.

Outdoor Unit -Wiring Diagram

WIRING DIAGRAM

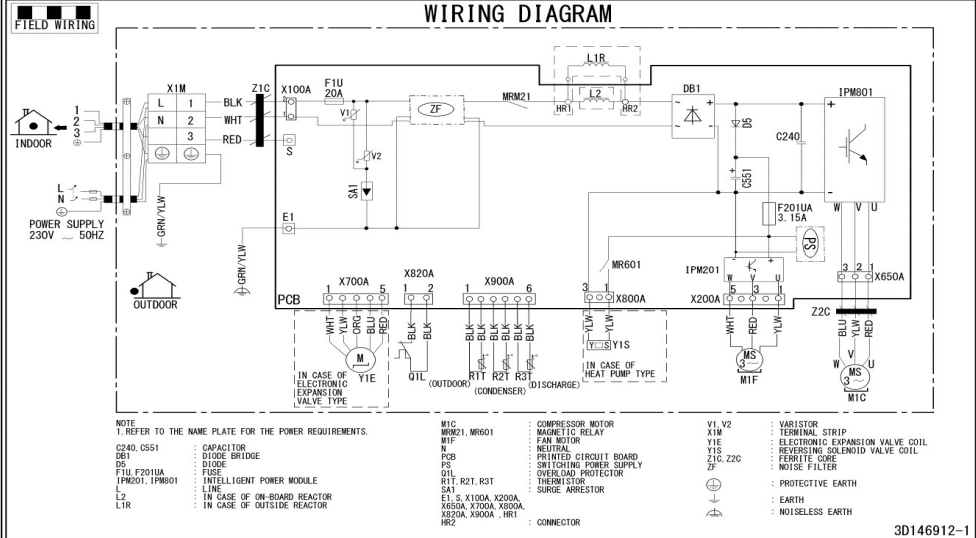

CAUTIONS

CONCERNING HANDLING OF HIGH VOLTAGE PARTS
DO NOT TOUCH THE CHARGED PARTS FOR 10 MINUTES
 AFTER THE SAFETY BREAKER IS TURNED OFF,
BECAUSE OF THE DANGER OF HIGH VOLTAGE

3P699384-3D

Applicable Model :- RKL650UV16VA, RKL650UV16VAF, RKC650UV16V, RKL50UV16VAF, RKC50UV16V, RKL650UV16VA, RKC650UV16VF, RKL650UV16VAF, RKL50UV16VA, RKL50UV16VA, RKC50UV16VF & RKL50UV16VAF.

WIRING DIAGRAM

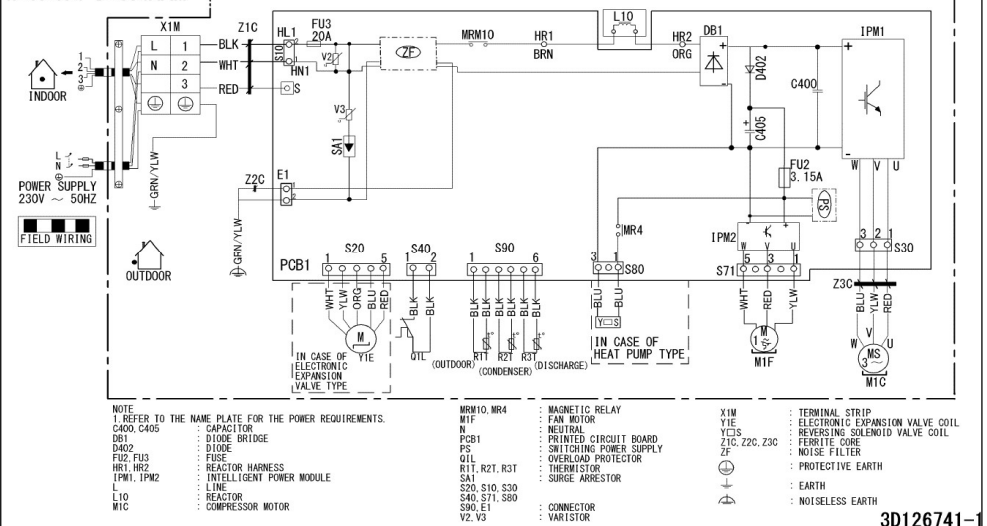

CAUTIONS

CONCERNING HANDLING OF HIGH VOLTAGE PARTS
DO NOT TOUCH THE CHARGED PARTS FOR 10 MINUTES
 AFTER THE SAFETY BREAKER IS TURNED OFF,
BECAUSE OF THE DANGER OF HIGH VOLTAGE

3P366378-16N

Applicable Model :- RKM60UV16U, RKM60UV16U, RKM60UV16U & RKM50UV16V.

Outdoor Unit -Wiring Diagram

WIRING DIAGRAM

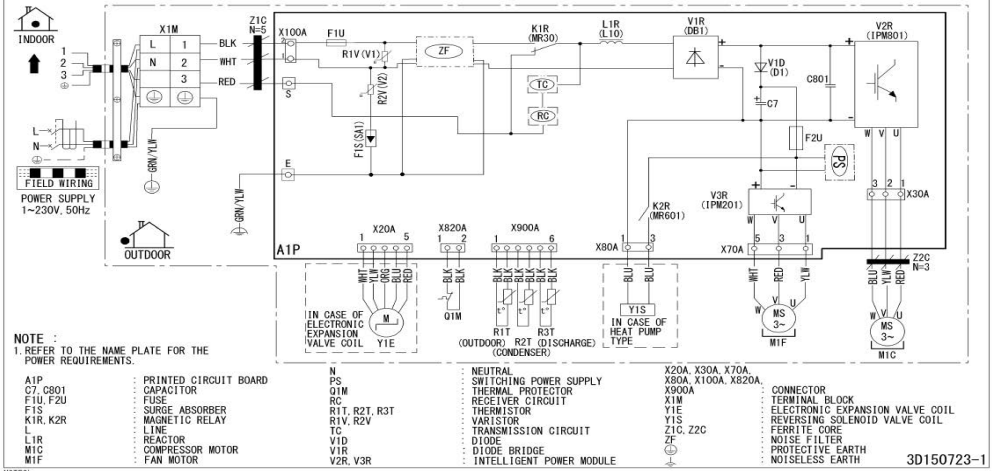

NOTE :
1. REFER TO THE NAME PLATE FOR THE POWER REQUIREMENTS.

- NOTES:
1. SIZE LENGTH 105 x WIDTH 185
2. REFER TO PURCHASING SPECIFICATION AS (Y)303002, UNLESS OTHERWISE SPECIFIED.
3. THIS DRAWING WAS DRAWN ON CAD SYSTEM
4. INDICATION OF DEVICE NUMBER ARE, INDICATE ACTUAL ON PCB WILL BE MENTION IN BRACKET (EX. R1V (V1), VIR (DB1) ETC.
5. GRAPHICAL SYMBOLS ARE REFER FROM STANDARD GAZ007-X.

CAUTIONS

CONCERNING HANDLING OF HIGH VOLTAGE PARTS
DO NOT TOUCH THE CHARGED PARTS FOR 10 MINUTES
AFTER THE SAFETY BREAKER IS TURNED OFF,
BECAUSE OF THE DANGER OF HIGH VOLTAGE

3P699384-6H

Applicable Model :- RKC42UV16V