

DAIKIN

DAIKIN ROOM AIR CONDITIONER

OPERATION MANUAL

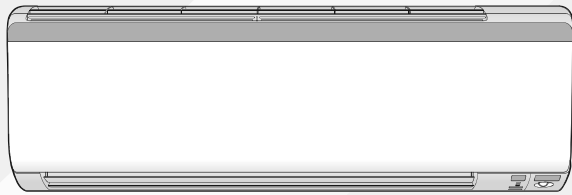

INVERTER

MODELS

GTKJ35TV16UZ+RKJG35TV16UZ
GTKJ50TV16UZ+RKJG50TV16UZ
GTKJ60TV16UZ+RKJG60TV16UZ

Features

Enhanced comfort and energy savings



INTELLIGENT EYE

The INTELLIGENT EYE sensor detects human movement in a room. If no one is in the room for more than 20 minutes, the operation automatically changes to energy saving operation.

▶ Page 14



FLASH STREAMER

Streamer and filtration technologies remove airborne allergens such as mould, mites and pollen as well as adjuvant substances, viruses and bacteria. ▶ Page 18

Other functions



COANDA

Directs airflow upward. This function prevents air from blowing directly at users. ▶ Page 14



OUTDOOR UNIT QUIET

OUTDOOR UNIT QUIET operation assures a low noise level of the outdoor unit. This function is useful to maintain a quiet neighbourhood.













▶ Page 17

Contents

■ Read before Operation

Safety Precautions.....	3
Name of Parts.....	4
Preparation before Operation	6

■ Operation

 DRY · COOL · FAN Operation.....	8
 Adjusting the Temperature	9
 Checking the Inverter Output and Temperature Display	10
 Adjusting the Airflow Direction	11
 Adjusting the Airflow Rate / SMELL PROOF Operation.....	12
 POWER CHILL Operation	13
 COANDA / INTELLIGENT EYE Operation.....	14
 ECONO / OUTDOOR UNIT QUIET Operation	17
 FLASH STREAMER AIR PURIFYING Operation	18
 ON/OFF TIMER Operation	19
 GOOD SLEEP OFF TIMER Operation	21
 CHILD LOCK	22

■ Care

Care and Cleaning.....	23
------------------------	-----------

■ Troubleshooting

Troubleshooting.....	27
----------------------	-----------



ECONO

This function enables efficient operation by limiting the maximum power consumption. It is useful when using the air conditioner and other electrical devices simultaneously on a shared electrical circuit. ▶Page 17

Safety Precautions



Read the precautions in this manual carefully before operating the unit.



This appliance is filled with R32.

- Keep this manual where the user can easily find it.
- Read the precautions in this manual carefully before operating the unit.
- The precautions described herein are classified as WARNING and CAUTION. They both contain important information regarding safety. Be sure to observe all precautions without fail.

WARNING

Failure to follow these instructions properly may result in personal injury or loss of life.

CAUTION

Failure to follow these instructions properly may result in property damage or personal injury, which may be serious depending on the circumstances.



Never attempt.



Be sure to follow the instructions.





Be sure to establish an earth connection.

- After reading, keep this manual in a convenient place so that you can refer to it whenever necessary. If the equipment is transferred to a new user, be sure also to hand over the manual.

WARNING

- To avoid fire, explosion or injury, do not operate the unit when harmful gases (e.g. flammable or corrosive) are detected near the unit. 
- Be aware that prolonged, direct exposure to cool air from the air conditioner, or to air that is too cool, can be harmful to your physical condition and health.
- Do not place objects, including rods, your fingers, etc., in the air inlet or outlet. Product damage may result due to contact with the air conditioner's high-speed fan blades.
- Do not attempt to repair, dismantle, reinstall or modify the air conditioner yourself as this may result in water leakage, electric shock or fire hazards.
- Do not use flammable spray near the air conditioner, or otherwise fire may result.
- Do not use a refrigerant other than the one indicated on the outdoor unit (R32) when installing, moving or repairing. Using other refrigerants may cause trouble or damage to the unit, and personal injury.
- To avoid electric shock, do not operate with wet hands.

- Beware of fire in case of refrigerant leakage. If the air conditioner is not operating correctly, i.e. not generating cool air, refrigerant leakage could be the cause. Consult your service centre for assistance. The refrigerant within the air conditioner is safe and normally does not leak. However, in the event of a leakage, contact with a naked burner, heater or cooker may result in generation of noxious gas. Do not use the air conditioner until a qualified service person confirms that the leakage has been repaired. 
- Do not attempt to install or repair the air conditioner yourself. Improper workmanship may result in water leakage, electric shock or fire hazards. Please contact your local service centre or qualified personnel for installation and maintenance work.
- If the air conditioner is malfunctioning (giving off a burning odour, etc.), turn off power to the unit and contact your local service centre. Continued operation under such circumstances may result in a failure, electric shock or fire hazards.
- Be sure to install an earth leakage circuit breaker. Failure to install the earth leakage circuit breaker may result in electric shock or fire.

- Be sure to earth the unit. Do not earth the unit to a utility pipe, lightning conductor or telephone earth lead. Imperfect earthing may result in electric shock. 

CAUTION

- Do not use the air conditioner for purposes other than those for which it is intended. Do not use the air conditioner for cooling precision instruments, food, plants, animals or works of art as this may adversely affect the performance, quality and/or longevity of the object concerned. 
- Do not expose plants or animals directly to the airflow from the unit as this may cause adverse effects.
- Do not place appliances that produce naked flames in places exposed to the airflow from the unit as this may impair combustion of the burner.
- Do not block the air inlets nor outlets. Impaired airflow may result in insufficient performance or trouble.
- Do not sit on the outdoor unit, put things on the unit, or pull the unit. Doing so may cause accidents, such as falling or toppling down, thus resulting in injury, product malfunctioning, or product damage.
- Do not place objects that are susceptible to moisture directly beneath the indoor or outdoor units. Under certain conditions, condensation on the main unit or refrigerant pipes, air filter dirt or drain blockage may cause dripping, resulting in fouling or failure of the object concerned.
- After prolonged use, check the unit stand and its mounts for damage. If they are left in a damaged condition, the unit may fall and cause injury.
- To avoid injury, do not touch the air inlet or aluminium fins of the indoor or outdoor units.
- The appliance is not intended for use by unattended young children or infirm persons. Impairment of bodily functions and harm to health may result.
- Children should be supervised to ensure that they do not play with the unit or its remote controller. Accidental operation by a child may result in impairment of bodily functions and harm health.
- Avoid impacts to the indoor and outdoor units, or otherwise product damage may result.
- Do not place flammable items, such as spray cans, within 1m of the air outlet. The spray cans may explode as a result of hot air from the indoor or outdoor units.
- Be careful not to let pets urinate on the air conditioner. Urination on the air conditioner may result in electric shock or fire.
- Do not wash the air conditioner with water, as this may result in electric shock or fire.
- Do not place water containers (vases, etc.) above the unit, as this may result in electric shock or fire hazards if they should topple over.
- Do not insert the batteries in the wrong polarity (+/-) orientation as this may result in short circuiting, fire, or battery leakage.

- To avoid oxygen depletion, ensure that the room is adequately ventilated if equipment such as a burner is used together with the air conditioner. 
- Before cleaning, be sure to stop unit operation and turn off the circuit breaker. Otherwise, an electric shock and injury may result.
- Only connect the air conditioner to the specified power supply circuit. Power supplies other than the one specified may result in electric shock, overheating and fires.
- Arrange the drain hose to ensure smooth drainage. Imperfect drainage may cause wetting of the building, furniture, etc.
- Do not place objects in direct proximity of the outdoor unit and do not let leaves and other debris accumulate around the unit. Leaves are a hotbed for small animals which can enter the unit. Once inside the unit, such animals can cause malfunctions, smoke or fire if they come into contact with electrical parts.
- Do not place objects around the indoor unit. Doing so may have an adverse influence on the performance, product quality, and life of the air conditioner.
- This appliance is not intended to be used by persons with reduced physical, sensory or mental capabilities, or with lack of operation knowledge, unless they have been given supervision or instruction concerning the appliance use by person responsible for their safety. Keep out of children's reach to ensure that they do not play with the appliance.

FTPK008-IN

Name of Parts

Indoor Unit

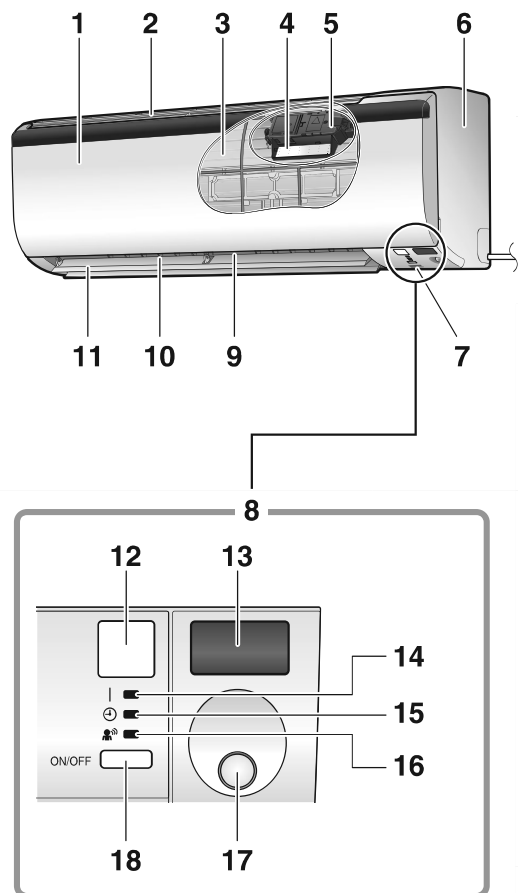

1. Front panel
2. Air inlet
3. Air filter
4. Accessory filter
5. Streamer unit
6. Model name
7. Indoor temperature sensor:
 - Detects the air temperature around the unit.
8. Display
9. Air outlet
10. Louvres (vertical blades):
 - The louvres are inside of the air outlet. ▶Page 11
11. Flaps (horizontal blades) ▶Page 11
12. Signal receiver:
 - Receives signals from the remote controller.
 - When the unit receives a signal, you will hear a beep sound.

Case	Sound type
Operation start	beep-beep
Settings changed	beep
Operation stop	long beep

13. Inverter output and temperature display ▶Page 10
14. OPERATION lamp (green)
15. TIMER lamp (orange) ▶Page 19-21
16. INTELLIGENT EYE lamp (green) ▶Page 15
17. INTELLIGENT EYE sensor ▶Page 14
18. Indoor unit ON/OFF switch:
 - Press this switch once to start operation. Press once again to stop it.
 - For the operation mode setting, refer to the following table.

Mode	Temperature setting	Airflow rate
COOL	22°C	AUTO

- This switch can be used when the remote controller is missing.
19. Air inlet (back and side)
 20. Outdoor temperature sensor (back)
 21. Refrigerant pipes and inter-unit wire
 22. Drain hose
 23. Earth terminal (inside)
 24. Model name
 25. Air outlet

Outdoor Unit

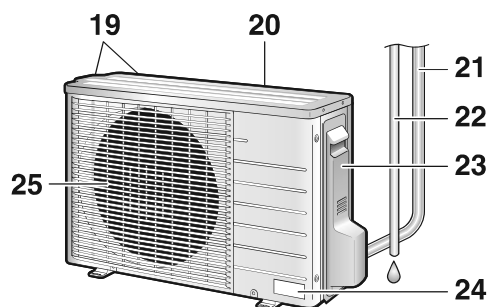

Appearance of the indoor/outdoor unit may differ between different models.

Name of Parts

■ Remote Controller

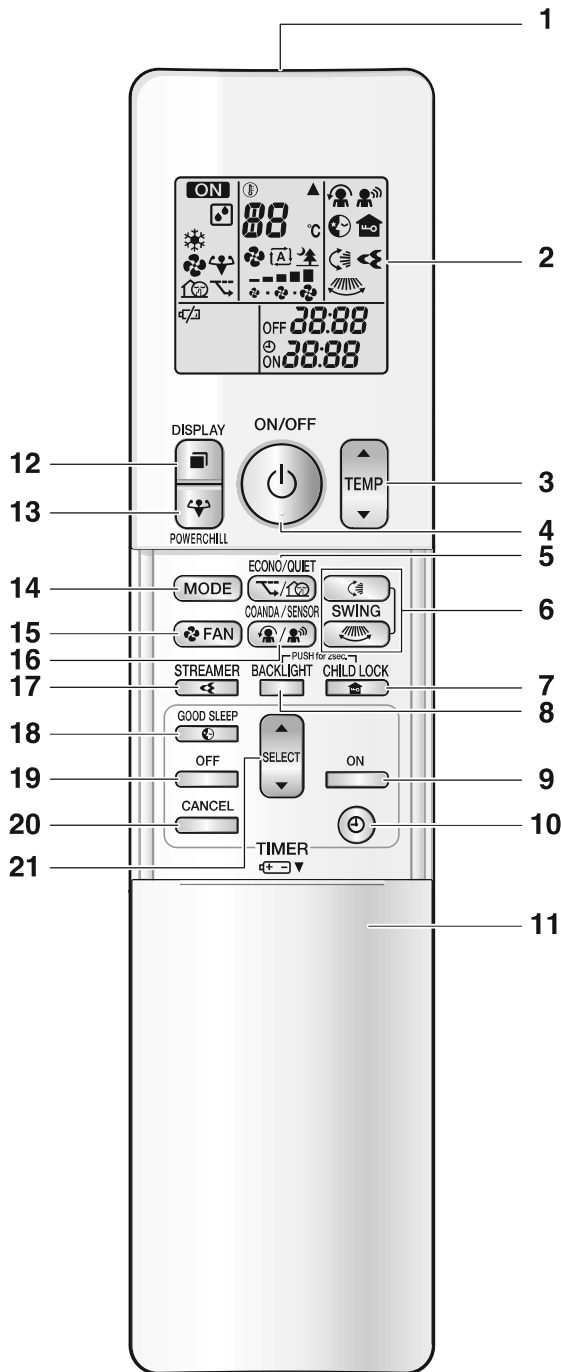

[Model: ARC479A22]

1. Signal transmitter:

- Sends signals to the indoor unit.

2. Display (LCD):

- Displays the current settings.
(In this illustration, each section is shown with its displays on for the purpose of explanation.)

3. TEMPERATURE adjustment button:

- Changes the temperature setting. ▶Page 9

4. ON/OFF button:

- Press this button once to start operation.
Press once again to stop it. ▶Page 8

5. ECONO/QUIET button ▶Page 17

6. SWING button:

- Adjusts the airflow direction. ▶Page 11

7. CHILD LOCK button ▶Page 22

8. BACKLIGHT button ▶Page 7

9. ON TIMER button ▶Page 19

10. CLOCK button ▶Page 7

11. Front cover:

- Open the front cover.

12. DISPLAY button ▶Page 10

13. POWER CHILL button ▶Page 13

14. MODE selector button:

- Selects the operation mode.
(DRY/COOL/FAN) ▶Page 8

15. FAN setting button:

- Selects the airflow rate setting. ▶Page 12

16. COANDA/SENSOR button ▶Page 15

17. STREAMER button ▶Page 18

18. GOOD SLEEP OFF TIMER button ▶Page 21

19. OFF TIMER button (NIGHT SET mode) ▶Page 20

20. TIMER CANCEL button:

- Cancels the timer setting. ▶Page 19-21

21. SELECT button:

- Changes the clock, ON/OFF TIMER and GOOD SLEEP OFF TIMER settings.

Preparation before Operation

CAUTION

Incorrect handling of batteries can result in injury from battery leakage, rupturing or heating, or lead to equipment failure. Please observe the following precautions and use safely.

- If the solution from the batteries should get in the eyes, do not rub the eyes. Instead, immediately flush the eyes with tap water and seek the attention of a medical professional.
- Keep batteries out of reach of children. In the event that batteries are swallowed, seek the immediate attention of a medical professional.
- Do not expose batteries to heat or fire. Do not disassemble or modify batteries. The insulation or gas release vent inside the battery may be damaged, resulting in battery leakage, rupturing, or heating.
- Do not damage or peel off labels on the batteries.

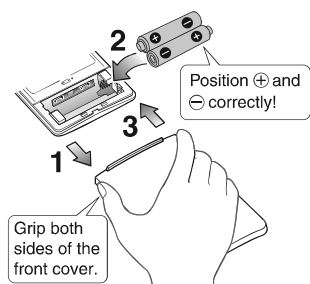

■ To insert the batteries

1. Slide the front cover to take it off.
2. Insert 2 dry batteries (AAA).
3. Set the front cover as before.

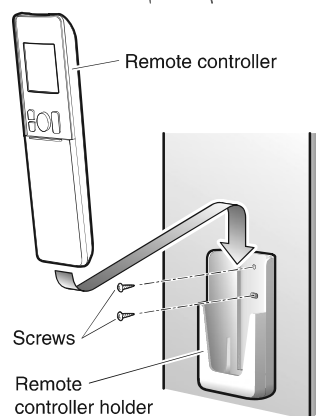

■ To attach the remote controller holder to a wall

1. Choose a place from where the signals reach the unit.
2. Attach the holder to a wall, a pillar, or similar location with the screws supplied with the holder.
3. Place the remote controller in the remote controller holder.

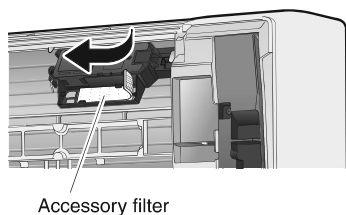

■ To attach the accessory filter

- Set the accessory filter under the tabs of the streamer unit. Filter type: Micro-filter (PM 0.1)
- When attaching the accessory filter, refer to “Care and Cleaning”, and pull out the air filters. [▶ Page 23, 24](#)

■ Turn on the circuit breaker

- After the power is turned on, the flaps of the indoor unit open and close once to set the reference position.

NOTE

■ Notes on batteries

- Do not use a leaking battery.
- To avoid possible injury or damage from battery leakage or rupturing, remove the batteries when not using the product for long periods of time.
- The standard replacement time is about 1 year. Both batteries should be replaced at the same time. Be sure to replace them with new size AAA dry batteries.
- When battery power has run out, “ ” will begin blinking on the LCD as an alert that the batteries need replacing. In some cases, when battery consumption is accelerated owing usage conditions, signal reception may decline before the LCD begins blinking.
- The batteries supplied with the remote controller are for initial operation. The batteries may run out in less than 1 year.

Preparation before Operation

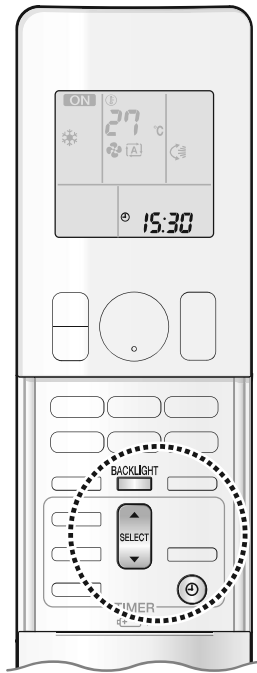

■ To set the clock

1. Press  .
 • “⌚” blinks.

2. Press  to set the clock to the present time.
• Holding down ▲ or ▼ rapidly increases or decreases the displayed time.

3. Press  .
 • “:” blinks.

■ To set the BACKLIGHT

Turning off the LCD backlight reduces battery consumption. (Default: on)

1. Press  for about 2 seconds.
• Pressing the button for about 2 seconds switches the backlight ON/OFF.
When it is switched off, the backlight goes out.
When it is switched on, the backlight comes on.

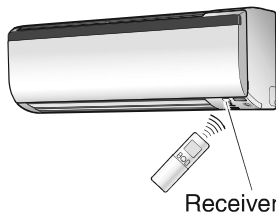

■ To operate the remote controller

- To use the remote controller, aim the transmitter at the indoor unit. If there is anything blocking the signals between the unit and the remote controller, such as a curtain, the unit will not operate.
- Do not drop the remote controller. Do not get it wet.
- The maximum transmission distance is about 7m.

NOTE

■ Notes on remote controller

- Never expose the remote controller to direct sunlight.
- Dust on the signal transmitter or receiver will reduce the sensitivity. Wipe off dust with soft cloth.
- Signal communication may be disabled if an electronic-starter-type fluorescent lamp (such as inverter-type lamps) is in the room. Consult your service centre if that is the case.
- If the remote controller activates other electric devices, move them away or consult your service centre.



DRY · COOL · FAN Operation

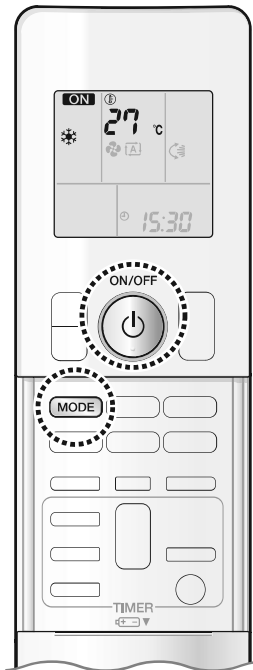

The air conditioner operates with the operation mode of your choice. From the next time on, the air conditioner will operate with the same operation mode.

■ To start operation

1. Press **MODE** and select an operation mode.

- Each pressing of the button changes the mode setting in sequence.

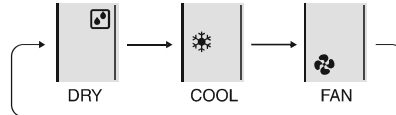

2. Press **ON/OFF**.

- “**ON**” is displayed on the LCD.
- The OPERATION lamp lights green.

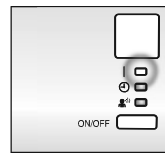

Display

■ To stop operation

1. Press **ON/OFF** again.

- “**ON**” disappears from the LCD.
- The OPERATION lamp goes off.
- All the indications disappear from the LCD. When the timer is set, the timer indication remains on the LCD.

NOTE

■ Note on COOL operation

- This air conditioner cools the room by releasing heat in the room outdoors. Therefore, cooling performance may fall in higher outdoor temperatures.

■ Note on DRY operation

- Eliminates humidity while maintaining the indoor temperature as much as possible. It automatically controls temperature and airflow rate, so manual adjustment of these functions is unavailable.

■ Note on FAN operation

- This mode is valid for fan only.



Adjusting the Temperature

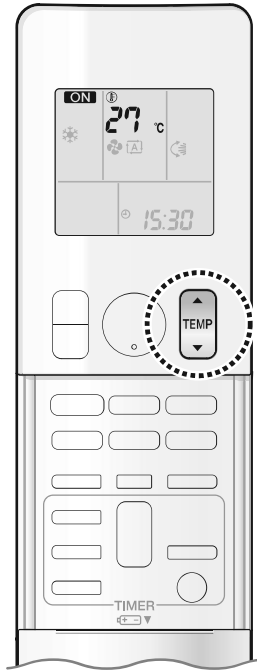

■ To change the temperature setting

1. Press .

- Press ▲ to raise the temperature and press ▼ to lower the temperature.

COOL operation	DRY or FAN operation
18-32°C	The temperature setting cannot be changed.

NOTE

■ Recommended temperature setting

- For cooling: 26-28°C

■ Notes on the operating conditions

- The air conditioner always consumes a small amount of electricity even while it is not operating.
- If you are not going to use the air conditioner for a long period, turn off the circuit breaker.
- Operation outside the humidity or temperature range described in the table may cause a safety device to disable the system.

Mode	Operating conditions	If operation is continued out of this range
COOL	Outdoor temperature: 10-50°C Indoor temperature: 18-32°C	<ul style="list-style-type: none"> • A safety device may activate to stop the operation. • Dew may form on the indoor unit and drip from it when COOL or DRY operation is selected.
DRY	Indoor humidity: 80% max.	

■ Tips for saving energy

- Be careful not to cool the room too much. Keeping the temperature setting at a moderate level helps save energy.
- Cover windows with a blind or a curtain. Blocking sunlight and air from outdoors increases the cooling effect.
- Clogged air filters cause inefficient operation and waste energy. Clean them once in about every 2 weeks.



Checking the Inverter Output and Temperature Display

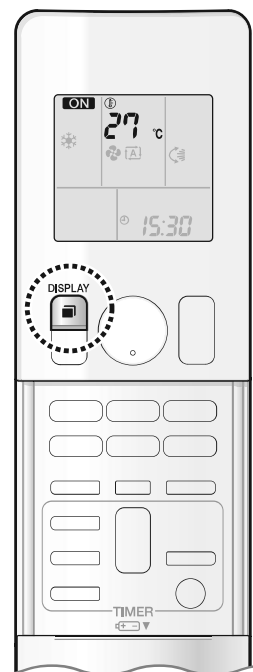

Inverter output and temperature display

The inverter output and temperature display for the indoor unit shows the current inverter output, indoor temperature, and set temperature.

■ Checking current inverter output, indoor temperature and set temperature when the air conditioner is in operation

1. Press  during operation.

- Each press of  cycles the display through current inverter output, indoor temperature, and set temperature.

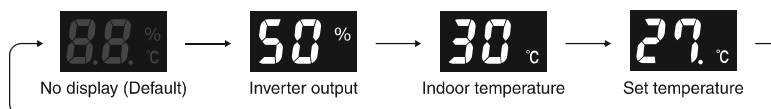

- Inverter output serves as an estimate of power consumption. (where rated power consumption is 100%)
- There is a “ . ” (dot) after the set temperature figure.
- Inverter output does not display when the unit is in FAN operation.
- Set temperature does not display when the unit is in DRY operation or FAN operation.
- Inverter output and set temperature may not display depending on the operation mode that is active.
- The display turns off when the unit is turned off.

■ Checking current indoor temperature when the air conditioner is off

1. Press  when the air conditioner is off.

- The current indoor temperature displays.
- Press the button again to turn off the display.

NOTE

■ Note on the inverter output and temperature display

- “FL” displays as inverter output when the rated power consumption is exceeded.
- “ - - ” may display for a short while after the air conditioner is turned on or at other times.
- Inverter output may be low at times for the purposes of protecting the product.
- When the unit is operated using another device, such as a wired remote controller or smartphone, the set temperature displayed may not match the set temperature on the remote controller.
- An error code will display if the air conditioner fails to operate when turned on. Consult your service centre. Refer to the error code table in “**Troubleshooting**”. 

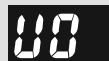



Adjusting the Airflow Direction

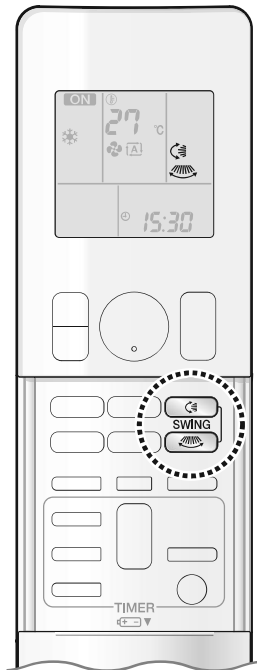

You can adjust the airflow direction to increase your comfort.

CAUTION

- Always use a remote controller to adjust the angles of the flaps and louvres.
- If you attempt to move the flaps and louvres forcibly by hand when they are swinging, the mechanism may be damaged.
- Inside the air outlet, a fan is rotating at a high speed.

■ To start auto swing

Up and down airflow direction

1. Press .

- “” is displayed on the LCD.
- The flaps (horizontal blades) will begin to swing.

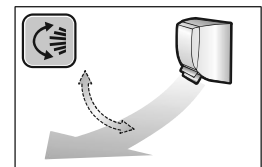

Right and left airflow direction



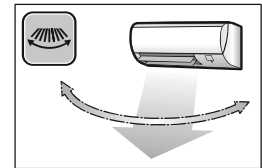

1. Press .

- “” is displayed on the LCD.
- The louvres (vertical blades) will begin to swing.



The 3-D airflow direction

1. Press  and .

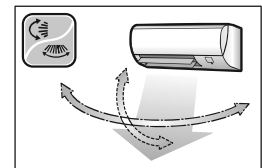

- “” and “” are displayed on the LCD.
- The flaps and louvres move in turn.
- To cancel 3-D airflow, press either  or  again. The flaps or louvres will stop moving.



■ To set the flaps or louvres at desired position

- This function is effective while the flaps or louvres are in auto swing mode.

1. Press  and  when the flaps or louvres reach the desired position.

- In the 3-D airflow, the flaps and louvres move in turn.
- “” or “” disappears from the LCD.

NOTE

■ Note on 3-D airflow

- Using 3-D airflow circulates cold air, which tends to collect at the bottom of the room, throughout the room, preventing areas of cold developing.



Adjusting the Airflow Rate / SMELL PROOF Operation

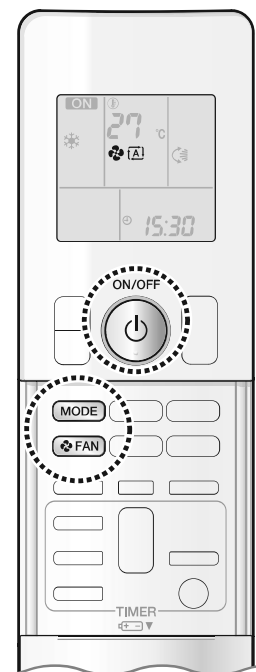

■ Adjusting the airflow rate

You can adjust the airflow rate to increase your comfort.

■ To change the airflow rate setting

1. Press **FAN**.

- Each pressing of **FAN** changes the airflow rate setting in sequence.

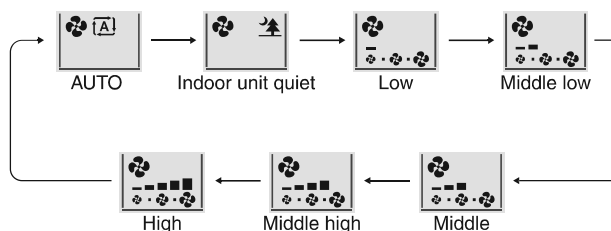

- When the airflow is set to “”, quiet operation starts and noise from the indoor unit will become quieter.
- In the quiet operation mode, the airflow rate is set to a weak level.
- In DRY operation, the airflow rate setting cannot be changed.

■ SMELL PROOF operation

The SMELL PROOF operation prevents unpleasant odour inside the indoor unit. This function is available in both DRY and COOL operation.

■ To use SMELL PROOF operation

1. Before starting the operation, press **FAN** to set to AUTO.
2. Press **MODE** to select the DRY or COOL operation.

3. Press **ON/OFF**.

- Air starts circulating about 1 minute after the operation is started. However, if the POWER CHILL operation is started, air starts circulating immediately.

■ To cancel SMELL PROOF operation

1. Change the airflow rate setting to a setting other than AUTO.

NOTE

■ Note on airflow rate setting

- At smaller airflow rates, the cooling effect is also smaller.

■ Note on SMELL PROOF operation

- SMELL PROOF operation can prevent some odours, but not all.



POWER CHILL Operation

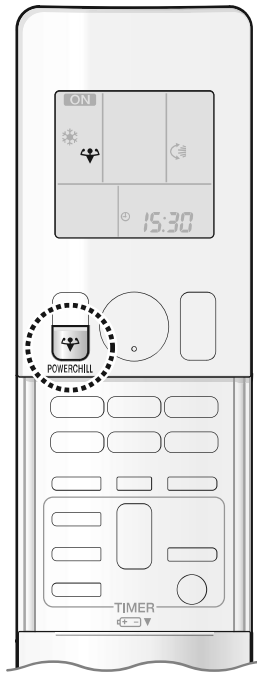

POWER CHILL operation quickly maximises the cooling effect in any operation mode. In this mode, the air conditioner operates at maximum capacity.

■ To start POWER CHILL operation



1. Press **POWERCHILL** during operation.

- “” is displayed on the LCD.
- POWER CHILL operation ends in 20 minutes. Then the system automatically operates again with the previous settings which were used before POWER CHILL operation.

■ To cancel POWER CHILL operation



1. Press **POWERCHILL** again.

- “” disappears from the LCD.

[Example]

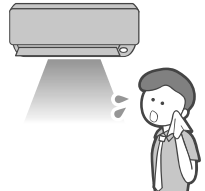

■ **Normal operation**

- When you want to get the cooling effect quickly, start the POWER CHILL operation.

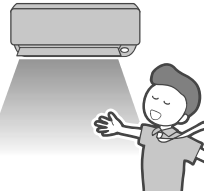

■ **POWER CHILL operation**

- POWER CHILL operation will work for 20 minutes.

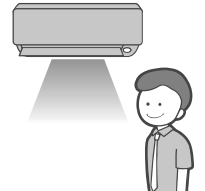



■ **Back to normal operation**

- POWER CHILL operation ends after 20 minutes.

NOTE

■ Notes on POWER CHILL operation

- When POWER CHILL operation is started, the flaps turn downward, allowing the air to blow directly onto people. When the up and down airflow direction is set to auto swing, the flaps move in auto swing mode.
- When using POWER CHILL operation, there are some functions which are not available.
- POWER CHILL operation cannot be used together with ECONO and OUTDOOR UNIT QUIET operation. Priority is given to the function of whichever button is pressed last.
- POWER CHILL operation can only be set when the unit is running. Pressing  causes the settings to be cancelled, and “” disappears from the LCD.
- POWER CHILL operation will not increase the capacity of the air conditioner if the air conditioner is already in operation with its maximum capacity demonstrated.
- **In COOL operation**
To maximise the cooling effect, the capacity of outdoor unit is increased and the airflow rate becomes fixed at the maximum setting.
The temperature and airflow settings cannot be changed.
- **In DRY operation**
The temperature setting is lowered by 2.5°C and the airflow rate is slightly increased.
- **In FAN operation**
The airflow rate is fixed at the maximum setting.



COANDA / INTELLIGENT EYE Operation

■ COANDA operation

Directs airflow upward. This function prevents air from blowing directly at users.

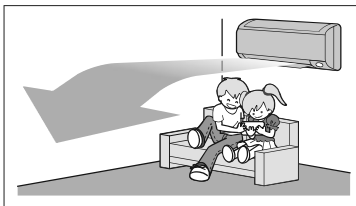

■ INTELLIGENT EYE operation

The INTELLIGENT EYE sensor detects human movement.

If no one is in the room for more than 20 minutes, the operation automatically changes to energy saving operation.

[Example]

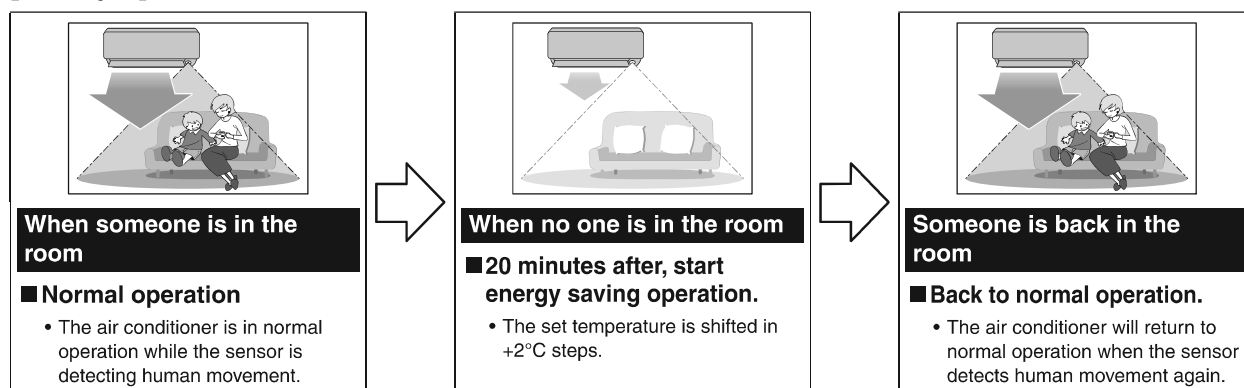

INTELLIGENT EYE operation is useful for energy saving

■ Energy saving operation

- If no presence detected in the room for 20 minutes, the energy saving operation will start, and the INTELLIGENT EYE lamp goes off. If human movement is detected again, the INTELLIGENT EYE lamp lights up and energy saving operation terminates.
- This operation changes the temperature by +2°C in COOL / +2°C in DRY operation from the set temperature. When the room temperature exceeds 30°C, the operation changes the temperature by +1°C in COOL / +1°C in DRY operation from the set temperature.
- This operation decreases the airflow rate slightly in FAN operation only.

■ Combination COANDA and INTELLIGENT EYE operation

The air conditioner can go into operation with the COANDA and INTELLIGENT EYE operations combined.



COANDA / INTELLIGENT EYE Operation

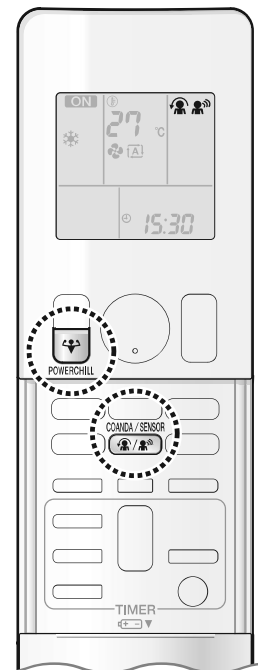

■ To start operation



COANDA / SENSOR

1. Press and select the desired mode.

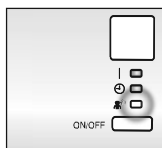
- Each time  is pressed a different setting option is displayed on the LCD.
- When INTELLIGENT EYE is selected, the INTELLIGENT EYE lamp lights green.



Display

- By selecting “ ” from the following icons, the air conditioner will switch to COANDA operation combined with INTELLIGENT EYE operation.

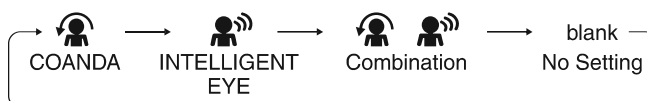



- When the flaps (horizontal blades) are swinging, selecting any of the modes above will cause the flaps (horizontal blades) to stop.

■ To cancel operation

COANDA / SENSOR

1. Press and select “blank” on the LCD.

- The INTELLIGENT EYE lamp goes off.

Display	Operation mode	Explanation
	COANDA	The flaps will adjust the airflow direction upward. ▶ Page 14
	INTELLIGENT EYE	The sensor will detect the movement of people in the sensing area. When there are no people in the sensing area, the air conditioner will go into energy-saving mode. ▶ Page 14
	COANDA and INTELLIGENT EYE	The air conditioner will be in COANDA operation combined with INTELLIGENT EYE operation. ▶ Page 14
Blank	No function	—

■ To combine COANDA and POWER CHILL operation

When POWER CHILL operation is started during COANDA operation, the flaps turn downward, allowing the air to blow directly onto people. The combination of COANDA and POWER CHILL operations provides sufficient cooling performance to quickly cool down the room.

1. Press during COANDA operation.

- After POWER CHILL operation is finished, the air conditioner automatically returns to COANDA operation.
- Pressing  during POWER CHILL operation prevents the air from blowing directly onto people while keeping POWER CHILL operation running.



COANDA / INTELLIGENT EYE Operation

⚠ CAUTION

- Do not place large objects near the INTELLIGENT EYE sensor.
Also keep heating units or humidifiers outside the sensor's detection area. This sensor can detect undesirable objects.
- Do not hit or violently push the INTELLIGENT EYE sensor. This can lead to damage and malfunction.

NOTE

■ Notes on COANDA operation

- If the up and down airflow direction is selected, the COANDA operation will be cancelled.
Priority is given to the function of whichever button is pressed last.

■ Notes on INTELLIGENT EYE operation

- Application range is as follows.

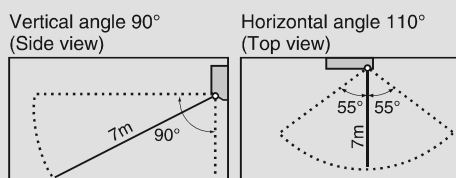

- If no people are detected in the sensing area for 20 minutes, the air conditioner switches to the energy-saving mode with the set temperature shifted by 2°C.
The air conditioner may switch to the energy-saving operation even if there are people in the area.
This may occur depending on the clothes the people are wearing if there is no movement of the people in the area.
- The sensor may not detect moving objects further than 7m away. (Please see the application range)
- Sensor detection sensitivity changes according to the indoor unit location, the speed of passers-by, temperature range, etc.
- The sensor could also mistakenly detect pets, sunlight, fluttering curtains and light reflected off of mirrors as passers-by.
- When the right and left airflow direction is set to auto swing during INTELLIGENT EYE operation, the louvres move in auto swing mode. Even under these conditions, energy saving operation is in effect.



ECONO / OUTDOOR UNIT QUIET Operation

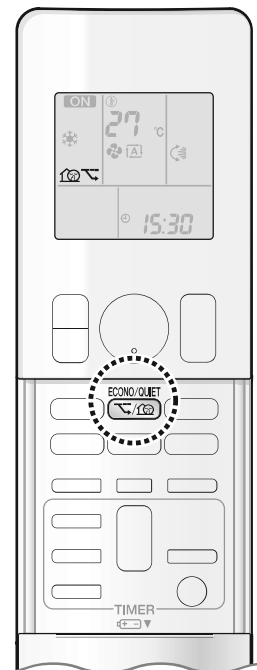

■ ECONO operation

ECONO operation enables efficient operation by limiting the maximum power consumption.

This function is useful to prevent the circuit breaker from tripping when the unit operates alongside other appliances on the same circuit.

■ OUTDOOR UNIT QUIET operation

OUTDOOR UNIT QUIET operation lowers the noise level of the outdoor unit by changing the frequency and fan speed of the outdoor unit. This function is convenient during the night-time operation.

■ To start operation

1. Press  and select the desired mode.

- Each time  is pressed, a different setting option is displayed on the LCD.

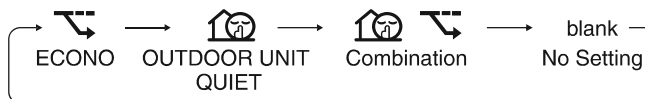

■ To cancel operation

1. Press  until no icon is displayed.

NOTE

■ Notes on ECONO operation

- ECONO operation can only be set when the unit is running. Pressing  causes the settings to be cancelled, and "ECONO" disappears from the LCD.
- ECONO operation is a function which enables efficient operation by limiting the power consumption of the outdoor unit.
- ECONO operation functions in COOL and DRY operation.
- POWER CHILL and ECONO operation cannot be used at the same time. Priority is given to the function of whichever button is pressed last.
- If the power consumption level is already low, switching to ECONO operation will not reduce the power consumption.
- This operation is performed with lower power and therefore may not provide a sufficient cooling effect.

■ Notes on OUTDOOR UNIT QUIET operation

- This function is available in COOL operation. This is not available in FAN and DRY operation.
- POWER CHILL operation and OUTDOOR UNIT QUIET operation cannot be used at the same time. Priority is given to the function of whichever button is pressed last.
- Even if the operation is stopped by using the remote controller or the indoor unit ON/OFF switch when using OUTDOOR UNIT QUIET operation, "OUTDOOR UNIT QUIET" will remain displayed on the remote controller.
- OUTDOOR UNIT QUIET operation will not reduce the frequency nor fan speed if they already are operating at reduced levels.
- This operation is performed with lower power and therefore may not provide a sufficient cooling effect.



FLASH STREAMER AIR PURIFYING Operation

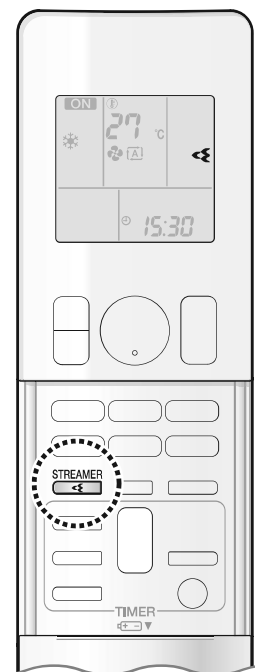

The absorption power of the accessory filter and the decomposition power of the streamer discharge combine to reduce unpleasant odours and viruses, cleaning the air in the room.

■ To start operation

1. Press ^{STREAMER}  .

- “” is displayed on the LCD.
- The air in the room is being cleaned.

■ To stop operation

1. Press ^{STREAMER}  .

- “” disappears from the LCD.
- The streamer will stop operating.

NOTE

■ What is streamer discharge?

- This is a type of plasma discharge comprising high-speed electrons with a high oxidative capacity that is released within the unit. It decomposes odours and harmful gases.
(The high-speed electrons are generated and then adsorbed within the unit to ensure your safety.)
- The streamer discharge may generate a hissing sound, however, this does not indicate a defect.

■ Note on FLASH STREAMER AIR PURIFYING operation

- When airflow is weak during operation, the streamer discharge may stop temporarily to prevent the emission of trace amounts of ozone from the air outlet.



ON/OFF TIMER Operation



Timer functions are useful for automatically switching the air conditioner on or off in the morning or at night. You can also use the ON TIMER and OFF TIMER together.

■ To use ON TIMER operation

- Check that the clock is correct.
If not, set the clock to the present time. ▶Page 7

1. Press .

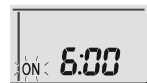

- “6:00” is displayed on the LCD.
- “ON” blinks.

- “⊕” disappears from the LCD.

2. Press  until the time setting reaches the point you like.

- Each pressing of either button increases or decreases the time setting by 10 minutes. Holding down either button changes the setting rapidly.

3. Press  again.

- “ON” and setting time are displayed on the LCD.
- The TIMER lamp lights orange. ▶Page 4

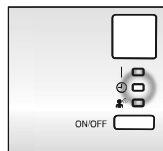

Display

■ To cancel ON TIMER operation

1. Press .

- “ON” and setting time disappear from the LCD.
- “⊕” is displayed on the LCD.
- The TIMER lamp goes off.

NOTE

■ Notes on TIMER operation

- When TIMER is set, the present time is not displayed.
- Once you set ON/OFF TIMER, the time setting is kept in the memory.
The memory is cleared when the remote controller batteries are replaced.
- When using the ON/OFF TIMER to start/stop operation, the actual operation start/stop time may differ from the time set.
(Maximum of about 10 minutes)

■ In the following cases, set the timer again.

- After the circuit breaker has turned off.
- After a power failure.
- After replacing the batteries in the remote controller.



ON/OFF TIMER Operation

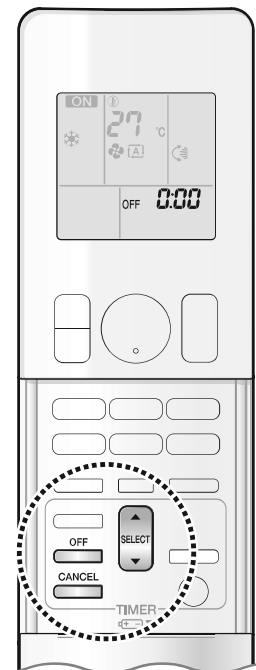

■ To use OFF TIMER operation

- Check that the clock is correct.
If not, set the clock to the present time. ▶ Page 7

1. Press .

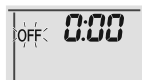

- “0:00” is displayed on the LCD.
- “OFF” blinks.

- “⊕” disappears from the LCD.

2. Press  until the time setting reaches the point you like.

- Each pressing of either button increases or decreases the time setting by 10 minutes. Holding down either button changes the time setting rapidly.

3. Press  again.

- “OFF” and setting time are displayed on the LCD.
- The TIMER lamp lights orange. ▶ Page 4

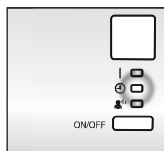

Display

■ To cancel OFF TIMER operation

1. Press .

- “OFF” and setting time disappear from the LCD.
- “⊕” is displayed on the LCD.
- The TIMER lamp goes off.

■ To combine ON TIMER and OFF TIMER

- A sample setting for combining the 2 timers is shown below.

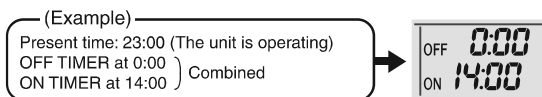



GOOD SLEEP OFF TIMER Operation

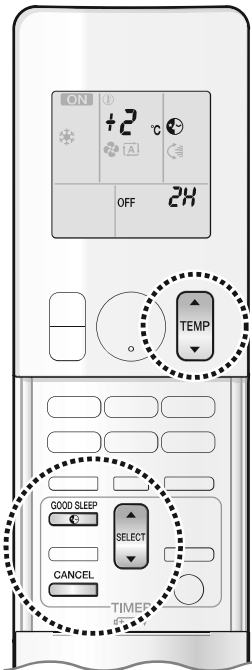

You can prevent excessive cooling of the room during sleep by setting a temperature shift value. The air conditioner automatically stops after the preset time has elapsed, thereby conserving electricity.

■ To use GOOD SLEEP OFF TIMER operation

1. Press  during COOL operation.

- “ °C ” blinks for a few seconds.
- The temperature shift value (default: +2) is displayed on the LCD for a few seconds.
- “ ☾ ”, “ OFF ”, and the stop time (default: 2H) , are displayed on the LCD.
- The TIMER lamp lights orange. [▶ Page 4](#)

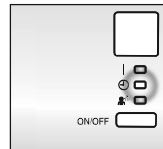

Display

2. Press  while “ °C ” is blinking.

- Each pressing of the button changes the temperature shift value by 1°C. You can specify a temperature shift value between +1°C and +5°C.

3. Press  or “  ” while “ °C ” is blinking.

- Each pressing of the button changes the time setting. The time can be set between 1 and 9 hours.

1 hour ... → 9 hours → OFF

■ To cancel GOOD SLEEP OFF TIMER operation

1. Press .

- “ ☾ ”, “ OFF ”, and the stop time indication disappear from the LCD.
- The TIMER lamp goes off.

NOTE

■ Notes on GOOD SLEEP OFF TIMER operation [Example]

- The set temperature increases by 0.5°C in 30 minutes until the total increase reaches the specified shift value. There is no function for heating the room.
- The temperature shift setting for GOOD SLEEP OFF TIMER operation is disabled while INTELLIGENT EYE operation is set. Cancel INTELLIGENT EYE operation.

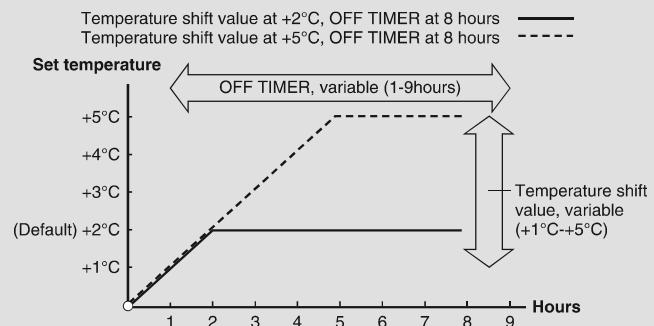



CHILD LOCK

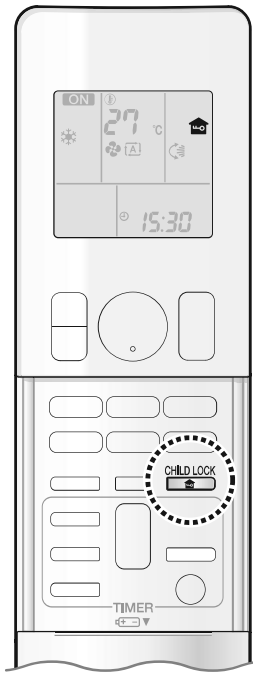



Setting the CHILD LOCK disables all the buttons except the CHILD LOCK button.

This function prevents children from operating the remote controller by mistake.

■ To set the CHILD LOCK

1. Press  for about 2 seconds.

- “” is displayed on the LCD.
- If a button is pressed while CHILD LOCK is on, “” blinks.

■ To cancel the CHILD LOCK

1. Press  for about 2 seconds again.

- “” disappears from the LCD.

Care and Cleaning

CAUTION

- Before cleaning, be sure to stop the operation and turn off the circuit breaker.
- Do not touch the aluminium fins of the indoor unit. If you touch those parts, this may cause an injury.
- When removing or attaching the front panel, stand on a solid, stable base and take care not to fall.
- When removing or attaching the front panel, support the panel securely with your hand to prevent it from falling.

Units

■ Indoor unit and remote controller

1. Wipe them with a dry soft cloth.

■ Front panel

1. Open the front panel.

- Hold the front panel by the indentations in the unit and open the front panel.

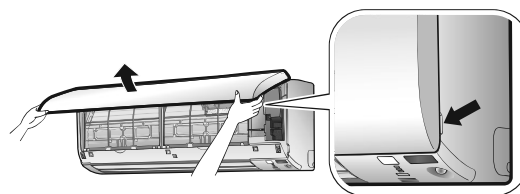

2. Remove the front panel.

- 1) Slide the front panel to either the left or right and pull it toward you to disengage one of the front panel shafts.
- 2) Disengage the front panel shaft on the other side in the same manner.
- 3) After disengaging both front panel shafts, pull the front panel toward yourself and remove it.

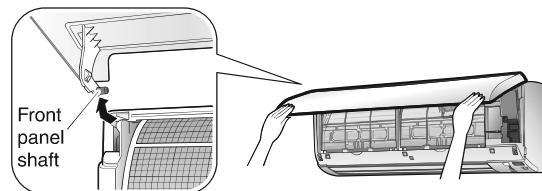

3. Clean the front panel.

- Wipe it with a soft damp cloth.
- Only neutral detergent may be used.
- In case of washing the panel with water, wipe it with a dry soft cloth, and let it dry in the shade after washing.

4. Attach the front panel.

- 1) Align the front panel shaft on the left and right of the front panel with the grooves, then push them all the way in.
- 2) Close the front panel slowly.
- 3) Press the front panel at both sides and the centre.
 - After cleaning, make sure that the front panel is securely fixed.

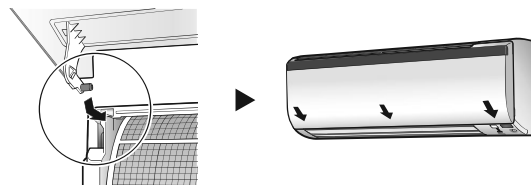

NOTE

For cleaning, do not use any of the following:

- Water hotter than 40°C
- Polishing compounds
- Volatile liquid such as benzene, petrol and thinner
- Rough materials such as a scrubbing brush

Care and Cleaning

Air filter

1. Pull out the air filters.

- Open the front panel.
- Push the filter tab at the centre of each air filter a little upwards, then pull it down.

2. Wash the air filters with water or clean them with a vacuum cleaner.

- It is recommended to clean the air filters every 2 weeks.
- If the dust does not come off easily, wash them with neutral detergent thinned with lukewarm water, then let them dry in the shade.

3. Reattach the filters and close the front panel.

- Insert the filters into slots of the front grille. Close the front panel slowly and push the panel at the 3 points.

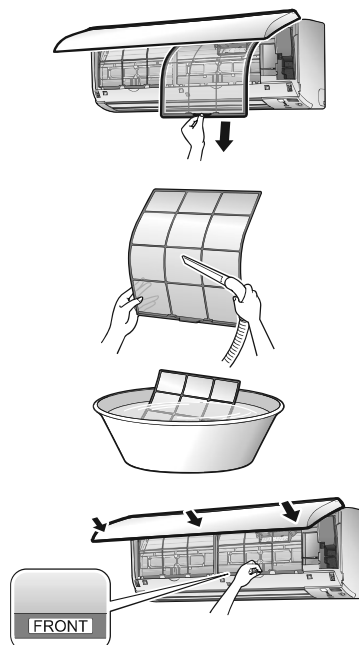

Accessory filter for streamer unit

Filter type: Micro-filter (PM0.1) / Micro-filter (PM2.5)

[Maintenance]

The accessory filter can be renewed by cleaning it with a vacuum cleaner once every 6 months. We recommend replacing it once every 6.5 years.

1. Take off the accessory filter.

- 1) Open the front panel and pull out the air filters.
- 2) Take off the accessory filter.
 - Remove the accessory filter from the tabs.

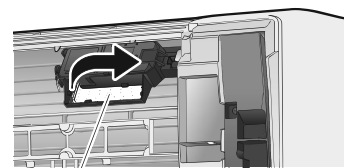

Accessory filter

2. Vacuum dust.

- Do not wash the accessory filter as this will reduce its efficiency.

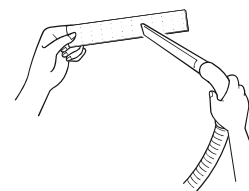

[Replacement]

1. Replace the old accessory filter with a new accessory filter.

Care and Cleaning

Accessory filter for front grille (sold separately)

Filter type: Ag-ion filter / Micro-filter (PM0.1 & PM 2.5)

Accessory filters can also be attached to the front grille.

[Attaching]

1. **Open the front panel and pull out the air filters.** ▶ Page 23, 24
2. **Set the accessory filters under the tabs of the filter frame on the indoor unit.**

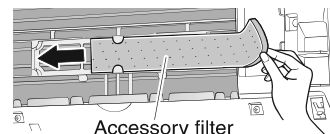

[Maintenance]

The accessory filters can be renewed by cleaning it with a vacuum cleaner once every 6 months. We recommend replacing them once every 3 years.

1. Take off the accessory filters.

- 1) Open the front panel and pull out the air filters. ▶ Page 23, 24
- 2) Take off the accessory filters.
 - Remove the accessory filters from the tabs.

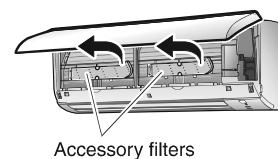

2. Vacuum dust.

- Do not wash the accessory filters as this will reduce their efficiency.

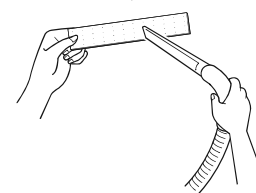

[Replacement]

1. **Replace the old accessory filters with new accessory filters.**

Accessory filter for front grille (sold separately)

Filter type: Titanium apatite deodorizing air-purifying filter/Anti microbial filter

Accessory filters can also be attached to the front grille.

[Attaching]

- Refer to the procedures above for attaching Anti microbial and Ag-ion filters.

[Maintenance]

The accessory filters can be renewed by washing them with water once every 6 months. We recommend replacing them once every 3 years.

1. Take off the accessory filters.

- Refer to the procedures above for removing Anti microbial and Ag-ion filters.

2. **Vacuum dust and soak in lukewarm water or water for about 10 to 15 minutes if very dirty.**

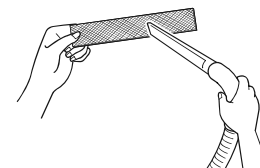

3. **After washing, shake off remaining water and dry in the shade.**

- Do not wring out the accessory filters to remove water from them.



[Replacement]

1. **Replace the old accessory filters with new accessory filters.**

Care and Cleaning

NOTE

- Dispose of the old filter as non-flammable waste.
- To order an accessory filter, contact your service centre.

Item	Part No.
Micro-filter (PM0.1) (for streamer unit) 1 no.	KAF010A506
Micro-filter (PM2.5) (for streamer unit) 1 no.	KAF250A505
Micro-filter (PM0.1) (for front grille) 1 set	KAF010A503
Micro-filter (PM2.5) (for front grille) 1 set	KAF250A502
Anti microbial filter (for front grille) 1 set	KAF500A504
Ag-ion filter (for front grille) 1 set	KAF057A41
Titanium apatite deodorizing air-purifying filter (for front grille) 1 set	KAF970A45

- Operation with dirty filter: (1) cannot deodorise the air. (2) cannot clean the air.
(3) results in poor cooling. (4) may cause odour.

■ Prior to a long period of non-use

1. Operate the FAN mode for several hours on a fine day to dry out the inside.

1) Press  and select FAN operation.

2) Press  and start the operation.

2. After operation stops, turn off the circuit breaker for the room air conditioner.

3. Clean the air filters and set them again.

4. To prevent battery leakage, take out the batteries from the remote controller.

We recommend periodical maintenance.

In certain operating conditions, the inside of the air conditioner may get foul after several seasons of use, resulting in poor performance. It is recommended to have periodical maintenance by a specialist in addition to regular cleaning by the user. For specialist maintenance, please contact your service centre.

The maintenance cost must be borne by the user.

Troubleshooting

These cases are not problems.

The following cases are not air conditioner troubles but have some reasons. You may just continue using it.

Case	Explanation
Operation does not start soon. <ul style="list-style-type: none"> When "ON/OFF" button was pressed soon after operation was stopped. When the mode was reselected. 	<ul style="list-style-type: none"> This is to protect the air conditioner. You should wait for about 3 minutes.
Air does not come out.	<ul style="list-style-type: none"> If the operation is started when the airflow setting is "Auto", the SMELL PROOF operation starts running to prevent unpleasant odour inside the indoor unit. Wait for about 1 minute. (Except when POWER CHILL operation is set.) ▶ Page 12
The flaps do not start swinging immediately.	<ul style="list-style-type: none"> The air conditioner is adjusting the position of the flaps. The flaps will start moving soon.
Operation stopped suddenly. (OPERATION lamp is on.)	<ul style="list-style-type: none"> To protect the system, the air conditioner may stop operating after sudden large voltage fluctuations. It automatically resumes operation in about 3 minutes. Voltage range protection: 130V-265V
A sound is heard.	<ul style="list-style-type: none"> ■ A sound like flowing water <ul style="list-style-type: none"> This sound is generated because the refrigerant in the air conditioner is flowing. This is a pumping sound of the water in the air conditioner and can be heard when the water is pumped out from the air conditioner during COOL or DRY operation. ■ Blowing sound <ul style="list-style-type: none"> This sound is generated when the flow of the refrigerant in the air conditioner is switched over. ■ Ticking sound <ul style="list-style-type: none"> This sound is generated when the cabinet and frame of the air conditioner slightly expand or shrink as a result of temperature changes. ■ Clopping sound <ul style="list-style-type: none"> This sound is heard from the inside of the air conditioner when the exhaust fan is activated while the room doors are closed. Open the window or turn off the exhaust fan.
The outdoor unit emits water or steam.	<ul style="list-style-type: none"> ■ In COOL or DRY operation <ul style="list-style-type: none"> Moisture in the air condenses into water on the cool surface of the outdoor unit piping and drips.
The INTELLIGENT EYE sensor does not respond.	<ul style="list-style-type: none"> The sensor is warming up for about 2 minutes after the power is turned on. Wait for a while. The sensor may not recognise small movements such as those made by sleeping persons or small children. The sensor may not work well if the indoor temperature is high. The sensor may not work well if the lens part of the INTELLIGENT EYE sensor is dirty. Clean it with a soft, dry cloth. In the event of a power failure, the position of the louvres is reset. Then, once the sensor detects the movement of people again, it directs the louvres at the area detected.
Mist comes out of the indoor unit.	<ul style="list-style-type: none"> This happens when the air in the room is cooled into mist by the cold airflow during COOL operation.
The indoor unit gives out odour.	<ul style="list-style-type: none"> The room odour absorbed in the unit is discharged with the airflow. We recommend you to have the indoor unit cleaned. Please consult your service centre.

Troubleshooting

Case	Explanation
The outdoor fan rotates while the air conditioner is not in operation.	<ul style="list-style-type: none"> ■ Immediately after the air conditioner is stopped: <ul style="list-style-type: none"> • The outdoor unit fan continues rotating for about another 1 minute to protect the system. ■ While the air conditioner is not in operation: <ul style="list-style-type: none"> • When the outdoor temperature is high, the outdoor unit fan may start rotating to protect the system.
Remote controller does not work properly.	<ul style="list-style-type: none"> ■ No remote controller signals are displayed. ■ The remote controller sensitivity is low. ■ The display is low in contrast or blacked out. ■ The display runs out of control. <ul style="list-style-type: none"> • The batteries are dying and the remote controller is malfunctioning. Replace both batteries with new, dry batteries (AAA). For details, refer to “To insert the batteries” of this manual. ▶ Page 6

Check again.

Please check again before requesting repairs.

Case	Explanation
The air conditioner does not operate. (OPERATION lamp is off.)	<ul style="list-style-type: none"> • Has the circuit breaker been tripped or the fuse blown? • Is there a power failure? • Are batteries set in the remote controller? • Is the timer setting correct?
The room does not cool down.	<ul style="list-style-type: none"> • Is the airflow rate setting appropriate? If the airflow rate setting is too low, increase it. • Is the set temperature appropriate? • Is the adjustment of the airflow direction appropriate? • Are the air filters dirty? • Is there anything blocking the air inlet or air outlet of the indoor unit or outdoor unit? • Is a window or door open? • Is the air conditioner in ECONO operation or GOOD SLEEP OFF TIMER operation?
Operation stops suddenly. (OPERATION lamp is blinking.)	<ul style="list-style-type: none"> • Are the air filters dirty? Clean the air filters. • Is there anything blocking the air inlet or air outlet of the indoor unit or outdoor unit? Stop operation and after turning off the circuit breaker, remove the obstruction. Then restart operation with the remote controller. If the OPERATION lamp is still blinking, check the error code and consult your service centre.
An abnormal functioning happens during operation.	<ul style="list-style-type: none"> • The air conditioner may malfunction with lightning or radio waves. Turn off the circuit breaker, turn it on again and try operating the air conditioner with the remote controller.

Troubleshooting

Call your service centre immediately.

WARNING

- When an abnormality (such as a burning smell) occurs, stop operation and turn off the circuit breaker. Continued operation in an abnormal condition may result in problems, electric shock or fire. Consult your service centre.
- Do not attempt to repair or modify the air conditioner by yourself. Incorrect work may result in electric shock or fire. Consult your service centre.

If one of the following symptoms takes place, call your service centre immediately.

- **The power cord is abnormally hot or damaged.**
- **An abnormal sound is heard during operation.**
- **The circuit breaker, a fuse, or the earth leakage circuit breaker cuts off the operation frequently.**
- **A switch or a button often fails to work properly.**
- **There is a burning smell.**
- **Water leaks from the indoor unit.**

Turn off the circuit breaker and call your service centre.

- **After a power failure**
The air conditioner automatically resumes operation in about 3 minutes. You should just wait for a while.
- **Lightning**
If there is a risk lightning could strike in the neighbourhood, stop operation and turn off the circuit breaker to protect the system.

Disposal requirements



Your air conditioning product is marked with this symbol. This means that electrical and electronic products shall not be mixed with unsorted household waste.

Do not try to dismantle the system yourself: the dismantling of the air conditioning system, treatment of the refrigerant, of oil and of other parts must be done by a qualified installer in accordance with relevant local and national legislation.

Air conditioners must be treated at a specialized treatment facility for re-use, recycling and recovery. By ensuring this product is disposed of correctly, you will help to prevent potential negative consequences for the environment and human health. Please contact the installer or local authority for more information.

Batteries must be removed from the remote controller and disposed of separately in accordance with relevant local and national legislation.

Troubleshooting

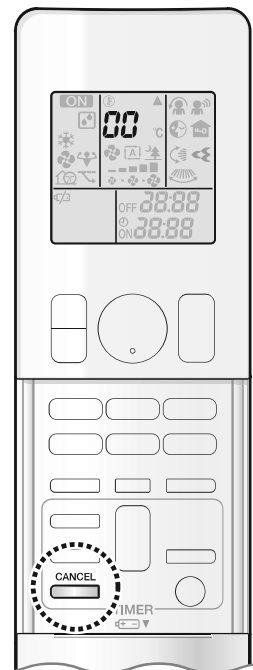

Fault diagnosis by remote controller

The remote controller can receive relevant error codes from the indoor unit.

1. When **CANCEL** is held down for about 5 seconds, “00” blinks in the temperature display section.
2. Press **CANCEL** repeatedly until a long beep is produced.
 - The code indication changes as shown below, and notifies with a long beep.

	CODE	MEANING
SYSTEM	00	NORMAL
	UA	INDOOR-OUTDOOR UNIT COMBINATION FAULT
	U0	REFRIGERANT SHORTAGE
	U2	DROP VOLTAGE OR MAIN CIRCUIT OVERVOLTAGE
	U4	FAILURE OF TRANSMISSION (BETWEEN INDOOR UNIT AND OUTDOOR UNIT)
INDOOR UNIT	A1	INDOOR PCB DEFECTIVENESS
	A5	FREEZE-UP PROTECTOR
	A6	FAN MOTOR FAULT
	C4	FAULTY HEAT EXCHANGER TEMPERATURE SENSOR
	C9	FAULTY SUCTION AIR TEMPERATURE SENSOR
OUTDOOR UNIT	E1	CIRCUIT BOARD FAULT
	E5	OL STARTED
	E6	FAULTY COMPRESSOR START UP
	E7	DC FAN MOTOR FAULT
	E8	OVERCURRENT INPUT
	F3	HIGH TEMPERATURE DISCHARGE PIPE CONTROL
	F6	HIGH PRESSURE CONTROL (IN COOLING)
	F8	OPERATION HALT DUE TO COMPRESSOR INTERNAL TEMPERATURE ABNORMALITY
	H0	SENSOR FAULT
	H6	OPERATION HALT DUE TO FAULTY POSITION DETECTION SENSOR
	H8	DC CURRENT SENSOR FAULT
	H9	FAULTY SUCTION AIR TEMPERATURE SENSOR
	J3	FAULTY DISCHARGE PIPE TEMPERATURE SENSOR
	J6	FAULTY HEAT EXCHANGER TEMPERATURE SENSOR
	L3	ELECTRICAL PARTS HEAT FAULT
	L4	HIGH TEMPERATURE AT INVERTER CIRCUIT HEATSINK
L5	OUTPUT OVERCURRENT	
P4	FAULTY INVERTER CIRCUIT HEATSINK TEMPERATURE SENSOR	

NOTE

- A short beep indicates non-corresponding codes.
- To cancel the code display, hold down **CANCEL** for about 5 seconds.
The code display also cancels itself if the button is not pressed for 1 minute.

Quick Reference

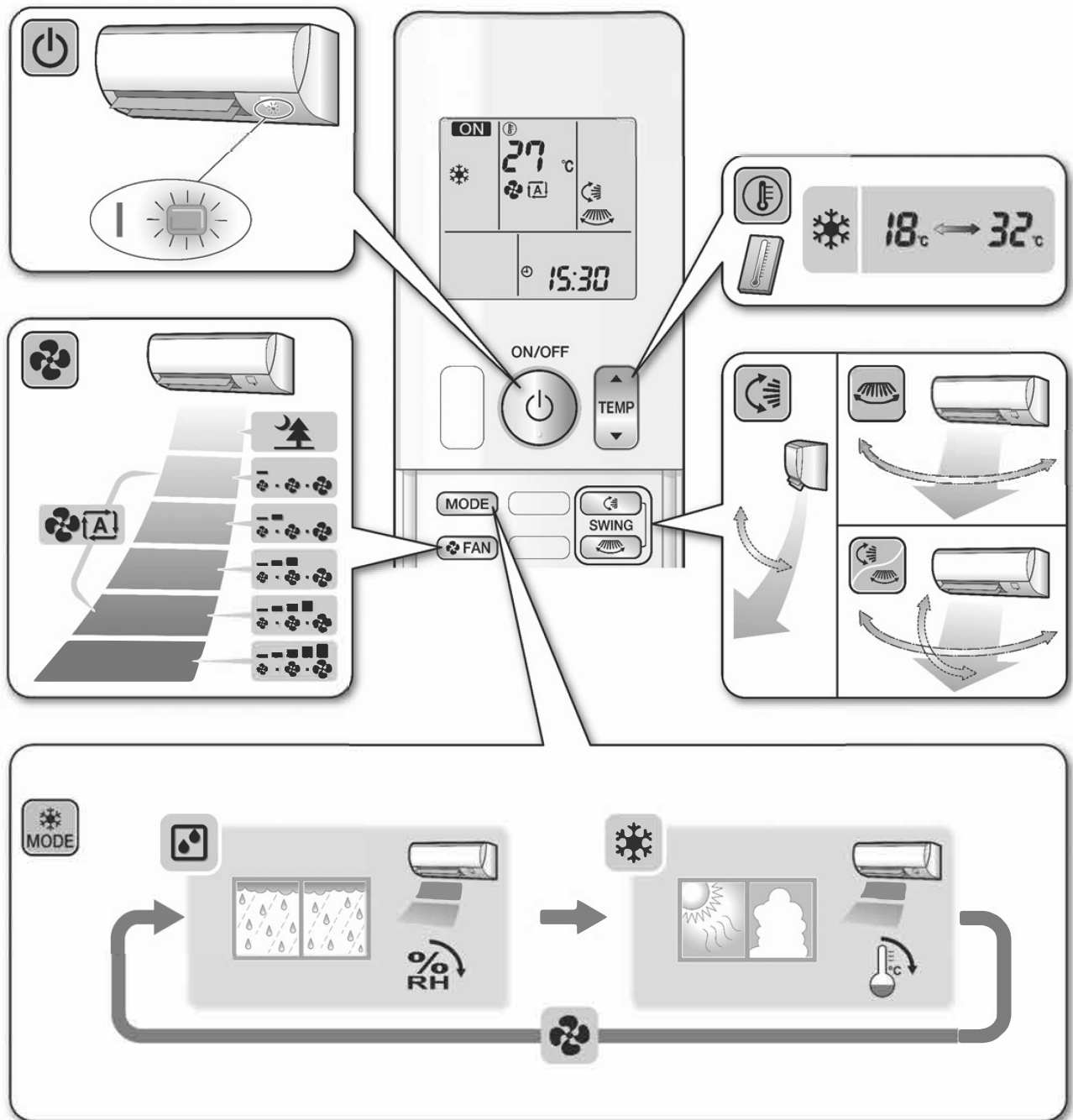

DAIKIN INDUSTRIES, LTD.

Head office:
Umeda Center Bldg., 2-4-12, Nakazaki-Nishi,
Kita-ku, Osaka, 530-8323 Japan

Tokyo office:
JR Shinagawa East Bldg., 2-18-1, Konan,
Minato-ku, Tokyo, 108-0075 Japan
<http://www.daikin.com>

DAIKIN AIR CONDITIONER INSTALLATION MANUAL

R32 Split Series **INVERTER**

Safety Precautions

Read the precautions in this manual carefully before operating the unit. This appliance is filled with R32.

- The precautions described herein are classified as WARNING and CAUTION. They both contain important information regarding safety. Be sure to observe all precautions without fail.
- Meaning of WARNING and CAUTION notices

WARNING Failure to follow these instructions properly may result in personal injury or loss of life.

CAUTION Failure to follow these instructions properly may result in property damage or personal injury, which may be serious depending on the circumstances.

- The safety marks shown in this manual have the following meanings:

Be sure to follow the instructions. Be sure to establish an earth connection. Never attempt.

- After completing installation, conduct a trial operation to check for faults and explain to the user how to operate the air conditioner and take care of it with the aid of the operation manual.

WARNING

- Ask your dealer or qualified personnel to carry out installation work. Do not attempt to install the air conditioner yourself. Improper installation may result in water leakage, electric shock or fire.
- Install the air conditioner in accordance with the instructions in this installation manual. Improper installation may result in water leakage, electric shock or fire.
- Be sure to use only the specified accessories and parts for installation work. Failure to use the specified parts may result in the unit falling, water leakage, electric shock or fire.
- Install the air conditioner on a foundation strong enough to hold the weight of the unit. A foundation of insufficient strength may result in the equipment falling and causing injury.
- Electrical work must be performed in accordance with relevant local and national regulations and with the instructions in this installation manual. Be sure to use a dedicated power supply circuit only. Insufficient power supply and improper workmanship may result in electric shock or fire.
- Use a cable of suitable length. Do not use tapped wires or an extension lead, as this may cause overheating, electric shock or fire.
- Make sure that all wiring is secured, the specified wires are used, and that there is no strain on the terminal connections or wires. Improper connections or securing of wires may result in abnormal heat build-up or fire.
- When wiring the power supply and connecting the wiring between the indoor and outdoor units, position the wires so that the electrical wiring box cover can be securely fastened. Improper positioning of the electrical wiring box cover may result in electric shock, fire or overheating terminals.
- If refrigerant gas leaks during installation, ventilate the area immediately. Toxic gas may be produced if the refrigerant comes into contact with fire.
- After completing installation, check for refrigerant gas leakage. Toxic gas may be produced if the refrigerant gas leaks into the room and comes into contact with a source of fire, such as a fan heater, stove or cooker.
- When installing or relocating the air conditioner, do not let any other substances besides R32, such as air, enter the refrigerant circuit. The presence of air or foreign matter in the refrigerant circuit causes an abnormal pressure rise, which may result in equipment damage and even injury.
- During installation, attach the refrigerant piping securely before operating the compressor. If the refrigerant pipes are not attached and the stop valve is open when the compressor is operated, air will be sucked in, causing abnormal pressure in the refrigeration cycle, which may result in equipment damage and even injury.
- During pump down, stop the compressor before removing the refrigerant piping. If the compressor is still operating and the stop valve is open during pump down, air will be sucked in when the refrigerant piping is removed, causing abnormal pressure in the refrigeration cycle, which may result in equipment damage and even injury.
- Be sure to earth the air conditioner. Do not earth the unit to a utility pipe, lightning conductor or telephone earth lead. Imperfect earthing may result in electric shock.
- Be sure to install an earth leakage circuit breaker. Failure to install an earth leakage circuit breaker may result in electric shock or fire.
- Do not pump down when the refrigerant has leaked, otherwise the compressor may be damaged.

CAUTION

- Do not install the air conditioner at any place where there is a danger of flammable gas leakage. In the event of a gas leakage, build-up of gas near the air conditioner may cause a fire to break out.
- While following the instructions in this installation manual, install drain piping to ensure proper drainage and insulate the piping to prevent condensation. Improper drain piping may result in indoor water leakage and property damage.
- Tighten the flare nut as specified, such as with a torque wrench. If the flare nut is too tight, it may crack after prolonged use, causing refrigerant leakage.
- Take adequate steps to prevent the outdoor unit being used as a shelter by small animals. If small animals or birds come into contact with electrical parts, this can cause malfunctions, smoke or fire. Please instruct the customer to always keep the area around the unit clean.
- The refrigerant circuit temperature will be high, therefore the inter-unit wire must be kept away from copper pipes that are not thermally insulated.

Accessories

(A) ~ (K)

(A) Mounting plate	1	(B) Mounting plate fixing screw M4 × 25L	7	(C) Accessory filter	1
(D) Wireless remote controller	1	(E) Remote controller holder	1	(F) Remote controller holder fixing screw M3 × 20L	2
(G) Dry battery (AAA)	2	(H) Indoor unit fixing screw M4 × 12L	2	(J) Operation manual	1
(K) Installation manual	1				

Precautions for Selecting a Location

- Before choosing the installation site, obtain user approval.

Indoor unit

The indoor unit should be positioned in a place where:

- the restrictions on the installation requirements specified in "Indoor/Outdoor Installation Diagram" are met,
- both the air inlet and air outlet are unobstructed,
- the unit is not exposed to direct sunlight,
- the unit is away from sources of heat or steam,
- there is no source of machine oil vapour (this may shorten the indoor unit service life),
- cool air is circulated throughout the room,
- the unit is away from electronic ignition type fluorescent lamps (inverter or rapid start type) as they may affect the remote controller range,
- the unit is at least 1m away from any television or radio set (the unit may cause interference with the picture or sound),
- the unit can be installed at the recommended height (1.8m),
- no laundry equipment is nearby.

Outdoor unit

The outdoor unit should be positioned in a place where:

- the restrictions on installation specified in "Outdoor Unit Installation Diagram" are met,
- drain water causes no trouble or problem in particular,
- both air inlet and outlet have clear paths of air (they should be free of snow in snowy districts),
- the unit is in a clear path of air but not directly exposed to rain, strong winds, or direct sunlight,
- there is no fear of inflammable gas leakage,
- the unit is not directly exposed to salt, sulfidized gases, or machine oil vapour (these may shorten the service life of the outdoor unit),
- operating sound or hot airflow does not cause trouble to neighbours,
- the unit is at least 3m away from any television or radio antenna.

Outdoor Unit Installation Space Requirements

CAUTION

When carrying the outdoor unit during installation, wear gloves to avoid injury.

- Position the unit on a horizontal surface. Any tilt in the unit (front to back, right to left) should be 3° or less to the horizontal.
- Where a wall or other obstacle is in the path of the outdoor unit's intake or exhaust airflow, follow the installation space requirements below.
- For any of the below installation patterns, the wall height on the outlet side should be 1200mm or less.

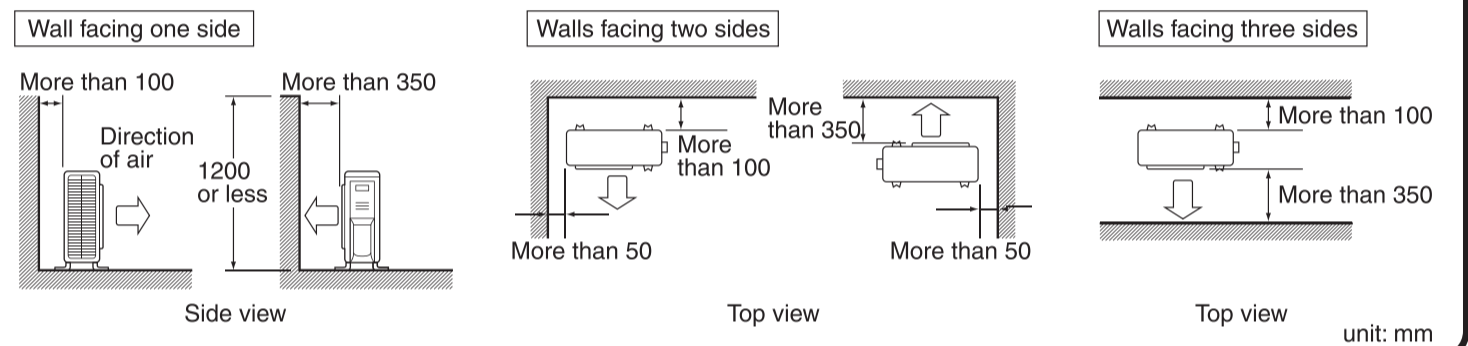
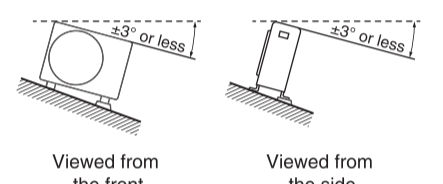

Indoor/Outdoor Unit Installation Diagram

CAUTION

- Do not hit or violently push the INTELLIGENT EYE sensor*. This can lead to damage and malfunction.
- Do not place large objects near the INTELLIGENT EYE sensor*. Also keep heating units or humidifiers outside the sensor's detection area.

*Only for GTKJ35TV16UZ

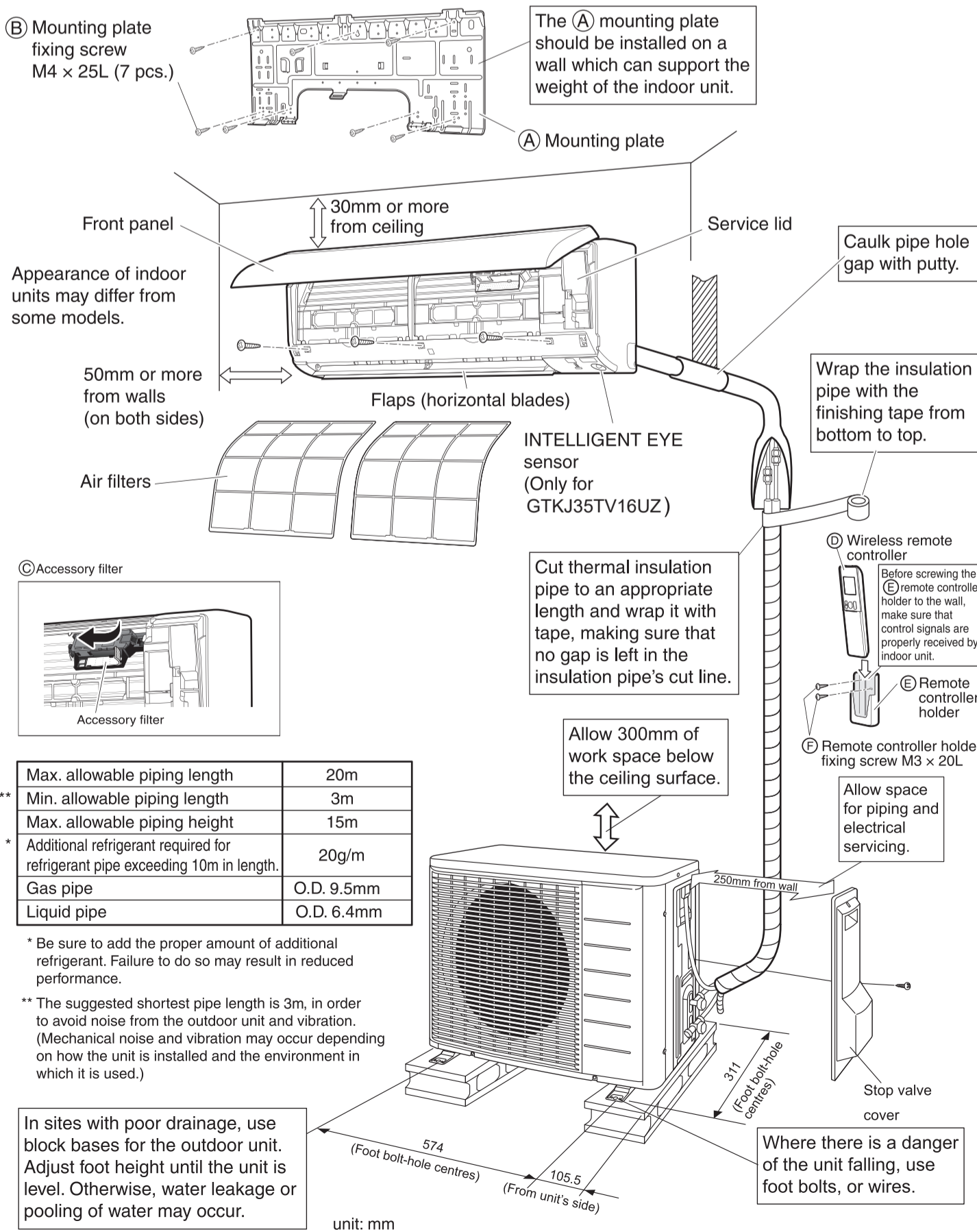

Installation Tips

Installing and Removing the indoor unit.

CAUTION

Do not hold the midsection of the bottom of the front grille when carrying the indoor unit.

Installation method

Hook the claws of the bottom frame to the (A) mounting plate. If the claws are difficult to hook, remove the front grille.

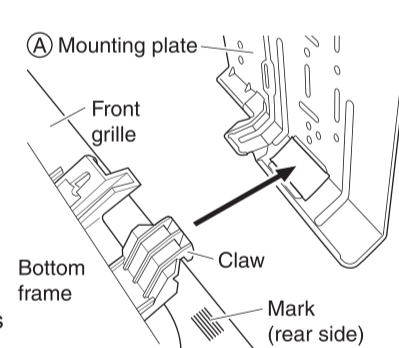

Removal method

Push up the marked area (at the lower part of the front grille) to release the claws. If it is difficult to release, remove the front grille.

Removing and installing the front panel.

Removal method

Hold the front panel by the indentations in the main unit and open the panel. Slide the front panel sideways to disengage the front panel shaft. Then pull the front panel toward you to remove it.

You can also remove the front panel by pushing it open until the front panel shaft is disconnected.

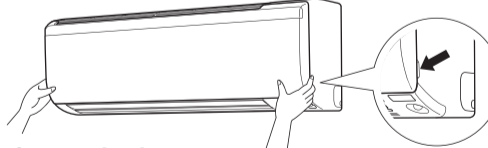

Installation method

Align the front panel shaft of the front panel with the grooves, and push all the way in, then close slowly. Push the centre of the lower surface of the panel firmly.

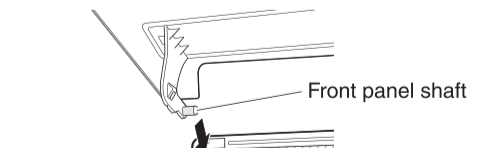

Removing and installing the front grille.

Removal method

- Remove the front panel and air filters.
- Remove the flap (horizontal blade).
- Remove the 3 screws from the front grille.
- In front of the ○○○ mark of the front grille, there are 3 upper hooks. Lightly pull the front grille toward you with one hand, and push down on the hooks with the fingers of your other hand.

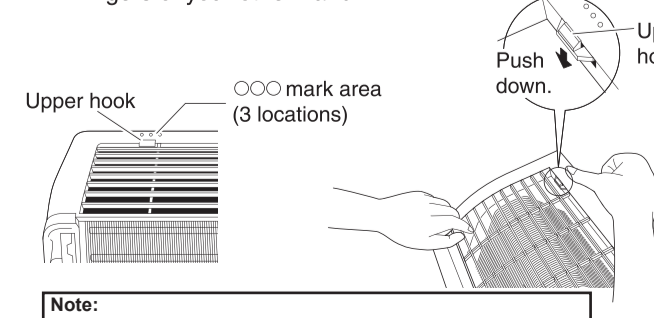

Note: Remove polythene film from front panel wherever applied.

When there is insufficient work space because the unit is close to ceiling

CAUTION

Be sure to wear protection gloves.

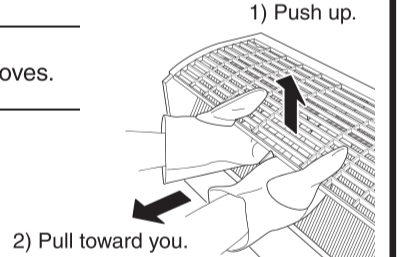

Place both hands under the centre of the front grille, and while pushing up, pull it toward you.

Installation method

- Install the front grille and firmly engage the upper hooks (3 locations).
- Install 3 screws of the front grille.
- Install the air filters and then mount the front panel.

Opening the service lid.

The service lid is removable.

Opening method

- Remove the service lid screw.
- Pull out the service lid diagonally down in the direction of the arrow.
- Pull down.

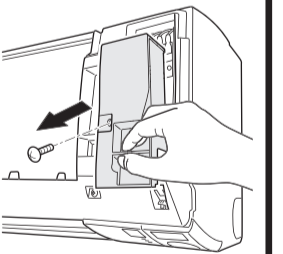

How to set the different addresses.

When 2 indoor units are installed in one room, the 2 wireless remote controllers can be set for different addresses. Change the address setting of one of the two units. When cutting the jumper (J4) be careful not to damage any of the surrounding parts.

- Remove the battery cover on the remote controller and cut the address jumper (J4).

Be careful not to cut jumper (J8).

- Press **TEMP**, **TEMP** and **MODE** at the same time.

- Press **TEMP**, select **⌘**, press **MODE**.

(The indoor unit OPERATION lamp will blink for about 1 minute.)

- Press the indoor unit ON/OFF switch while the OPERATION lamp is blinking.

If setting could not be carried out completely while the OPERATION lamp was blinking, carry out the setting process once again from the beginning.

After setting is complete, pressing **MODE** for about 5 seconds will cause the remote controller to return to the previous display.

